

# Robust Control Toolbox

For Use with **MATLAB®**

*Gary Balas  
Richard Chiang  
Andy Packard  
Michael Safonov*

- Computation
- Visualization
- Programming

## How to Contact The MathWorks:



www.mathworks.com      Web  
comp.soft-sys.matlab      Newsgroup



support@mathworks.com      Technical support  
suggest@mathworks.com      Product enhancement suggestions  
bugs@mathworks.com      Bug reports  
doc@mathworks.com      Documentation error reports  
service@mathworks.com      Order status, license renewals, passcodes  
info@mathworks.com      Sales, pricing, and general information



508-647-7000      Phone



508-647-7001      Fax



The MathWorks, Inc.      Mail  
3 Apple Hill Drive  
Natick, MA 01760-2098

For contact information about worldwide offices, see the MathWorks Web site.

### *Robust Control Toolbox User's Guide*

© COPYRIGHT 1992–2005 by The MathWorks, Inc.

The software described in this document is furnished under a license agreement. The software may be used or copied only under the terms of the license agreement. No part of this manual may be photocopied or reproduced in any form without prior written consent from The MathWorks, Inc.

**FEDERAL ACQUISITION:** This provision applies to all acquisitions of the Program and Documentation by, for, or through the federal government of the United States. By accepting delivery of the Program or Documentation, the government hereby agrees that this software or documentation qualifies as commercial computer software or commercial computer software documentation as such terms are used or defined in FAR 12.212, DFARS Part 227.72, and DFARS 252.227-7014. Accordingly, the terms and conditions of this Agreement and only those rights specified in this Agreement, shall pertain to and govern the use, modification, reproduction, release, performance, display, and disclosure of the Program and Documentation by the federal government (or other entity acquiring for or through the federal government) and shall supersede any conflicting contractual terms or conditions. If this License fails to meet the government's needs or is inconsistent in any respect with federal procurement law, the government agrees to return the Program and Documentation, unused, to The MathWorks, Inc.

MATLAB, Simulink, Stateflow, Handle Graphics, Real-Time Workshop, and xPC TargetBox are registered trademarks of The MathWorks, Inc.

Other product or brand names are trademarks or registered trademarks of their respective holders.

Revision History:	August 1992	First printing	New for Version 1
	January 1998	Online only	Revised for Version 2
	June 2001	Online only	Revised for Version 2.0.8 (Release 12.1)
	June 2004	Online only	Revised for Version 2.0.9 (Release 14)
	October 2004	Online only	Revised for Version 3 (Release 14SP1)
	March 2005	Online only	Revised for Version 3.0.1 (Release 14SP2)

## Introduction

1

<b>What Is the Robust Control Toolbox?</b> .....	1-2
Required Software .....	1-2
<b>Modeling Uncertainty</b> .....	1-3
Example: ACC Benchmark Problem .....	1-3
<b>Worst Case Performance</b> .....	1-7
Example: ACC Two Cart Benchmark Problem .....	1-7
<b>Synthesis of Robust MIMO Controllers</b> .....	1-10
Example: Designing a Controller with LOOPSYN .....	1-10
<b>Model Reduction and Approximation</b> .....	1-14
Example: NASA HIMAT Controller Order Reduction .....	1-14
<b>LMI Solvers</b> .....	1-18
<b>Extends Control System Toolbox</b> .....	1-19
<b>About the Authors</b> .....	1-20
<b>Bibliography</b> .....	1-21

## Multivariable Loop Shaping

2

<b>Tradeoff between Performance and Robustness</b> .....	2-2
Norms and Singular Values .....	2-2
<b>Typical loop shapes, S and T Design</b> .....	2-5
Singular Values .....	2-6

Guaranteed Gain/Phase Margins in MIMO Systems . . . . .	2-9
<b>Using LOOPSYN to do <i>H-Infinity</i> Loop Shaping . . . . .</b>	<b>2-11</b>
Example: NASA HiMAT loop-shaping . . . . .	2-11
Design Specifications . . . . .	2-13
MATLAB Commands for a LOOPSYN design . . . . .	2-13
<b>Using MIXSYN for H-Infinity Loop Shaping . . . . .</b>	<b>2-18</b>
Example: NASA HiMAT design using MIXSYN . . . . .	2-19
<b>Loop Shaping Commands . . . . .</b>	<b>2-21</b>

## Model Reduction for Robust Control

# 3

<b>Introduction . . . . .</b>	<b>3-2</b>
Hankel Singular Values . . . . .	3-2
<b>Overview of Model Reduction Techniques . . . . .</b>	<b>3-4</b>
<b>Approximating Plant Models -- Additive Error Methods . . . . .</b>	<b>3-6</b>
<b>Approximating Plant Models -- Multiplicative Error Method . . . . .</b>	<b>3-8</b>
<b>Using Modal Algorithms . . . . .</b>	<b>3-10</b>
Rigid Body Dynamics . . . . .	3-10
<b>Reducing Large Scale Models . . . . .</b>	<b>3-13</b>
<b>Using Normalized Coprime Factor Methods . . . . .</b>	<b>3-14</b>
<b>References . . . . .</b>	<b>3-15</b>

<b>Uncertainty Modeling</b> .....	4-2
Creating Uncertain Models of Dynamic Systems .....	4-2
Creating Uncertain Parameters .....	4-3
Quantifying Unmodeled Dynamics .....	4-5
<b>Robustness Analysis</b> .....	4-8
<b>Multi-Input, Multi-Output Robustness Analysis</b> .....	4-12
Adding Independent Input Uncertainty to Each Channel .....	4-13
Closed-Loop Robustness Analysis .....	4-15
Nominal Stability Margins .....	4-17
Robustness of Stability Model Uncertainty .....	4-18
<b>Worst-Case Gain Analysis</b> .....	4-20
<b>Summary of Robustness Analysis Tools</b> .....	4-23

## H-Infinity and Mu Synthesis

<b>H-Infinity Performance</b> .....	5-2
Performance as Generalized Disturbance Rejection .....	5-2
Robustness in the $H^\infty$ Framework .....	5-8
<b>Application of <math>H^\infty</math> and <math>\mu</math> to Active Suspension Control</b> .	5-10
Quarter Car Suspension Model .....	5-10
Linear $H^\bullet$ Controller Design .....	5-12
$H^\bullet$ Control Design 1 .....	5-13
$H^\bullet$ Control Design 2 .....	5-14
Control Design via $m$ -Synthesis .....	5-19
<b>Functions for Control Design</b> .....	5-24

<b>Appendix: Interpretation of H-Infinity norm</b> .....	<b>5-26</b>
Norms of Signals and Systems .....	<b>5-26</b>
Using Weighted Norms to Characterize Performance .....	<b>5-28</b>
 <b>References</b> .....	 <b>5-33</b>

## Building Uncertain Models

# 6

<b>Introduction to Uncertain Atoms</b> .....	<b>6-2</b>
Uncertain Real Parameters .....	<b>6-3</b>
Uncertain LTI Dynamics Atoms .....	<b>6-10</b>
Complex Parameter Atoms .....	<b>6-13</b>
Complex Matrix Atoms .....	<b>6-15</b>
Unstructured Uncertain Dynamic Systems .....	<b>6-17</b>
 <b>Uncertain Matrices</b> .....	 <b>6-19</b>
Creating Uncertain Matrices from Uncertain Atoms .....	<b>6-19</b>
Accessing Properties of a umat .....	<b>6-20</b>
Row and Column Referencing .....	<b>6-21</b>
Matrix Operation on umat Objects .....	<b>6-22</b>
Substituting for Uncertain Atoms .....	<b>6-23</b>
 <b>Uncertain State-Space Systems (uss)</b> .....	 <b>6-25</b>
Creating Uncertain Systems .....	<b>6-25</b>
Properties of uss Objects .....	<b>6-26</b>
Sampling Uncertain Systems .....	<b>6-27</b>
Feedback Around Uncertain Plant .....	<b>6-28</b>
Interpreting Uncertainty in Discrete Time .....	<b>6-30</b>
Lifting a ss to a uss .....	<b>6-31</b>
Handling Delays in uss .....	<b>6-31</b>
 <b>Uncertain frd</b> .....	 <b>6-33</b>
Creating Uncertain Frequency Response Objects .....	<b>6-33</b>
Properties of ufrd objects .....	<b>6-33</b>
Interpreting Uncertainty in Discrete Time .....	<b>6-36</b>
Lifting an frd to a ufrd .....	<b>6-36</b>

Handling Delays in ufrd .....	6-36
<b>Basic Control System Toolbox Interconnections .....</b>	<b>6-37</b>
<b>Simplifying Representation of Uncertain Objects .....</b>	<b>6-38</b>
Effect of AutoSimplify Property .....	6-39
Direct Use of simplify .....	6-41
<b>Sampling Uncertain Objects .....</b>	<b>6-42</b>
Generating One Sample .....	6-42
Generating Many Samples .....	6-42
Sampling ultidyn Atoms .....	6-43
<b>Substitution by usubs .....</b>	<b>6-46</b>
Specifying the Substitution with Structures .....	6-47
Nominal and Random Values .....	6-47
<b>Array Management for Uncertain Objects .....</b>	<b>6-49</b>
Referencing Arrays .....	6-49
Creating Arrays with stack, cat .....	6-50
Creating Arrays by Assignment .....	6-52
Binary Operations with Arrays .....	6-53
Creating Arrays With usample .....	6-53
Creating Arrays With usubs .....	6-55
Creating Arrays with gridureal .....	6-56
Creating Arrays with repmat .....	6-57
Creating Arrays with repsys .....	6-58
Using permute and ipermute .....	6-58
<b>Decomposing Uncertain Objects (for Advanced Users) ..</b>	<b>6-60</b>
Normalizing Functions for Uncertain Atoms .....	6-60
Properties of the Decomposition .....	6-61
Syntax of lftdata .....	6-62
Advanced Syntax of lftdata .....	6-64

## Generalized Robustness Analysis

---

### 7

<b>Introduction to Generalized Robustness Analysis</b> . . . . .	7-2
<b>Robust Stability Margin</b> . . . . .	7-5
<b>Robust Performance Margin</b> . . . . .	7-6
<b>Worst-Case Gain Measure</b> . . . . .	7-7

## Introduction to Linear Matrix Inequalities

---

### 8

<b>Linear Matrix Inequalities</b> . . . . .	8-2
LMI Features . . . . .	8-2
<b>LMIs and LMI Problems</b> . . . . .	8-4
The Three Generic LMI Problems . . . . .	8-5
<b>Further Mathematical Background</b> . . . . .	8-9
<b>References</b> . . . . .	8-10

## The LMI Lab

---

### 9

<b>Introduction</b> . . . . .	9-2
Some Terminology . . . . .	9-2
Overview of the LMI Lab . . . . .	9-5
<b>Specifying a System of LMIs</b> . . . . .	9-7
A Simple Example . . . . .	9-8
Initializing the LMI System . . . . .	9-10



Specifying the LMI Variables .....	9-10
Specifying Individual LMIs .....	9-12
Specifying LMIs With the LMI Editor .....	9-15
How It All Works .....	9-18
<b>Querying the LMI System Description .....</b>	<b>9-19</b>
lmiinfo .....	9-19
lminbr and matnbr .....	9-19
<b>LMI Solvers .....</b>	<b>9-20</b>
<b>From Decision to Matrix Variables and Vice Versa .....</b>	<b>9-26</b>
<b>Validating Results .....</b>	<b>9-27</b>
<b>Modifying a System of LMIs .....</b>	<b>9-28</b>
Deleting an LMI .....	9-28
Deleting a Matrix Variable .....	9-28
Instantiating a Matrix Variable .....	9-29
<b>Advanced Topics .....</b>	<b>9-31</b>
Structured Matrix Variables .....	9-31
Complex-Valued LMIs .....	9-33
Specifying $c^T x$ Objectives for mincx .....	9-36
Feasibility Radius .....	9-37
Well-Posedness Issues .....	9-38
Semi-Definite B(x) in gevp Problems .....	9-39
Efficiency and Complexity Issues .....	9-39
Solving $M + PTXQ + QTXTP < 0$ .....	9-40
<b>References .....</b>	<b>9-42</b>

## Function Reference

# 10

<b>Functions — Categorical List .....</b>	<b>10-2</b>
Uncertain Elements .....	10-2

Uncertain Matrices and Systems .....	10-2
Manipulation of Uncertain Models .....	10-2
Interconnection of Uncertain Models .....	10-3
Model Order Reduction .....	10-3
Robustness and Worst-Case Analysis .....	10-4
Robustness Analysis for Parameter-Dependent Systems (P-Systems) .....	10-5
Controller Synthesis .....	10-6
m-Synthesis .....	10-6
Sampled-Data Systems .....	10-7
Gain Scheduling .....	10-7
Supporting Utilities .....	10-7
Specification of Systems of LMIs .....	10-7
LMI Characteristics .....	10-8
LMI Solvers .....	10-8
Validation of Results .....	10-8
Modification of Systems of LMIs .....	10-9
<b>Functions — Alphabetical List .....</b>	<b>10-10</b>

## Index

---

# Introduction

---

What Is the Robust Control Toolbox? (p. 1-2)	Tools for analysis and design of uncertain control systems
Modeling Uncertainty (p. 1-3)	How to model uncertain parameters, matrices and systems
Worst Case Performance (p. 1-7)	Computing worst-case values for uncertain systems
Synthesis of Robust MIMO Controllers (p. 1-10)	Designing controllers that optimize worst case performance and maximize stability margins ( $H_\infty$ , $H_2$ , loop-shaping, mixed sensitivity, $\mu$ -synthesis, and LMI optimization)
Model Reduction and Approximation (p. 1-14)	Simplifying high-order LTI plant and controller models
LMI Solvers (p. 1-18)	Tools for solving Linear Matrix Inequalities
Extends Control System Toolbox (p. 1-19)	How the Robust Control Toolbox uses LTI objects and commands from the Control System Toolbox
About the Authors (p. 1-20)	Brief biographies of the toolbox authors
Bibliography (p. 1-21)	A list of sources on robust control theory

## What Is the Robust Control Toolbox?

The Robust Control Toolbox (RCT) is a collection of functions and tools that help you to analyze and design MIMO control systems with uncertain elements. You can build uncertain LTI system models containing uncertain parameters and uncertain dynamics. You get tools to analyze MIMO system stability margins and worst case performance.

The Robust Control Toolbox includes a selection of control synthesis tools that compute controllers that optimize worst-case performance and identify worst-case parameter values. The toolbox lets you simplify and reduce the order of complex models with model reduction tools that minimize additive and multiplicative error bounds. And, it provides tools for implementing advanced robust control methods like  $H_\infty$ ,  $H_2$ , Linear Matrix Inequalities (LMI), and  $\mu$ -synthesis robust control. You can shape MIMO system frequency responses and design uncertainty tolerant controllers.

### Required Software

The Robust Control Toolbox requires that you have installed the Control System Toolbox.

## Modeling Uncertainty

At the heart of robust control is the concept of an uncertain LTI system. Model uncertainty arises when system gains or other parameters are not precisely known, or may vary over a given range. Examples of real parameter uncertainties include uncertain pole and zero locations, and uncertain gains. One may also have unstructured uncertainties, by which one means complex parameter variations satisfying given magnitude bounds.

With the Robust Control Toolbox you can create uncertain LTI models as MATLAB<sup>®</sup> objects specifically designed for robust control applications. You can build models of complex systems by combining models of subsystems using addition, multiplication, and division, as well as with Control System Toolbox commands like `feedback` and `lft`.

### Example: ACC Benchmark Problem

For instance, consider the two-cart “ACC Benchmark” system [13] consisting of two frictionless carts connected by a spring as shown in shown below.

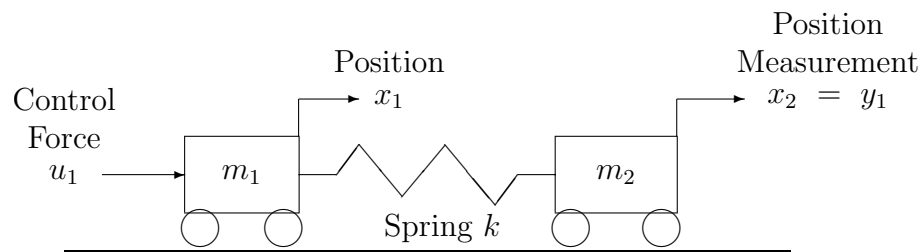

**Figure 1-1: ACC benchmark problem**

The system has block diagram model shown in Figure 1-2, where the individual carts have respective transfer functions

$$G_1(s) = \frac{1}{m_1 s^2}; \quad G_2(s) = \frac{1}{m_2 s^2}.$$

The parameters  $m_1$ ,  $m_2$  and  $k$  are uncertain, equal to one plus or minus 20%:

$$m_1 = 1 \pm 0.2$$

$$m_2 = 1 \pm 0.2$$

$$k = 1 \pm 0.2$$

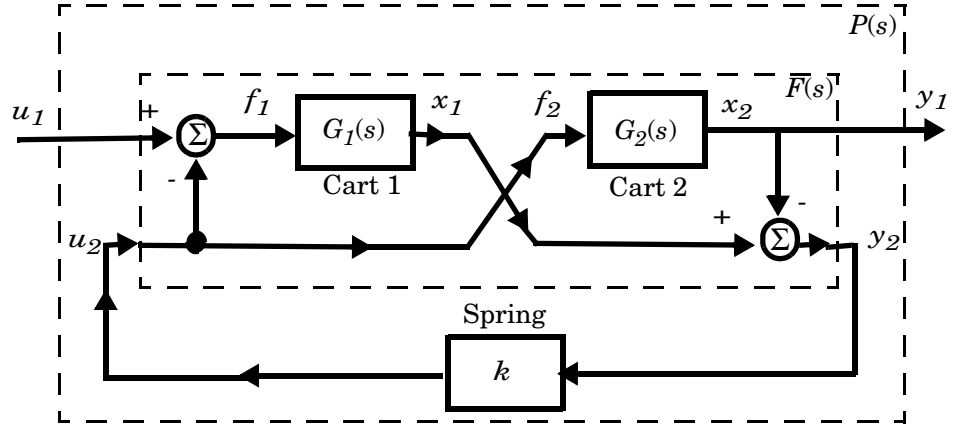

**Figure 1-2: “ACC benchmark” two-cart system block diagram  $y_1 = P(s) u_1$**

The upper dashed-line block has transfer function matrix

$$F(s) = \begin{bmatrix} 0 \\ G_1(s) \end{bmatrix} \begin{bmatrix} 1 & -1 \end{bmatrix} + \begin{bmatrix} 1 \\ -1 \end{bmatrix} \begin{bmatrix} 0 & G_2(s) \end{bmatrix}$$

This code builds the uncertain system model P shown in Figure 1-2:

```

% Create the uncertain reak parameters m1, m2 & k
m1 = ureal('m1',1,'percent',20);
m2 = ureal('m2',1,'percent',20);
k = ureal('k',1,'percent',20);

s = zpk('s'); % create the Laplace variable s
G1 = ss(1/s^2)/m1; % Cart 1
G2 = ss(1/s^2)/m2; % Cart 2

% Now build F and P
F = [0;G1]*[1 -1]+[1;-1]*[0,G2];
P = lft(F,k) % close the loop with the spring k

```

The variable  $P$  is a SISO uncertain state-space (USS) object, with 4 states, and 3 uncertain parameters  $m_1$ ,  $m_2$  and  $k$ . You can recover the nominal plant with the command

```
zpk(P.nominal)
```

which returns

```
Zero/pole/gain:
      1
-----
s^2 (s^2 + 2)
```

If the uncertain model  $P(s)$  has LTI negative feedback controller

$$C(s) = \frac{100(s+1)}{(0001s+1)^3}$$

,

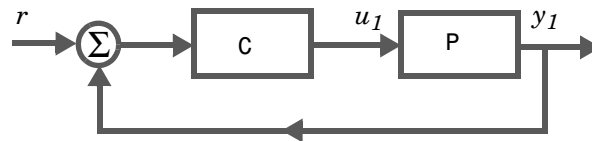

then you can form the controller and the closed-loop system  $y_1 = T(s) u_1$  and view the closed-loop system's step response on the time interval from  $t=0$  to  $t=0.1$  for a "Monte Carlo" random sample of 5 combinations of the 3 uncertain parameters  $k$ ,  $m_1$  and  $m_2$  using this code:

```
C=100*ss((s+1)/(.001*s+1))^3; % LTI controller
T=feedback(P*C,1); % closed-loop uncertain system
step(usample(T,5),.1);
```

The resulting plot is shown in Figure 1-3 below.

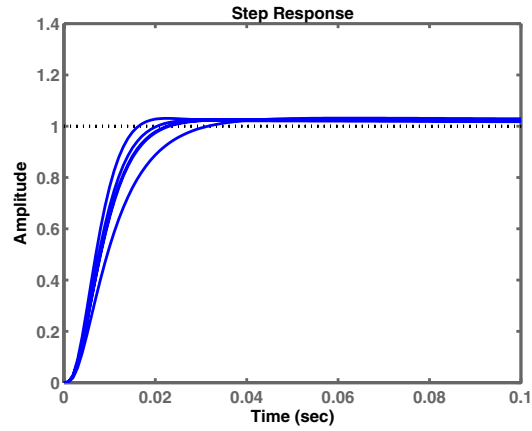

**Figure 1-3: "Monte Carlo" sampling of uncertain system's step response.**



## Worst Case Performance

To be robust, your control system should meet your stability and performance requirements for all possible values of uncertain parameters. Monte Carlo parameter sampling via `usample` can be used for this purpose as shown in Figure 1-4, but Monte Carlo methods are inherently hit or miss. With Monte Carlo methods, you might need to take an impossibly large number of samples before you hit upon or near a worst-case parameter combination.

The Robust Control Toolbox gives you a powerful assortment of *robustness analysis* commands that let you directly calculate upper and lower bounds on worst-case performance without random sampling:

---

### Worst-Case Robustness Analysis Commands

---

<code>loopmargin</code>	Comprehensive analysis of feedback loop.
<code>loopsens</code>	Sensitivity functions of feedback loop.
<code>ncfmargin</code>	Normalized coprime stability margin of feedback loop.
<code>robustperf</code>	Robust performance of uncertain systems.
<code>robuststab</code>	Stability margins of uncertain systems.
<code>wcgain</code>	Worst-case gain of an uncertain system.
<code>wcmargin</code>	Worst-case gain/phase margins for feedback loop.
<code>wcsens</code>	Worst-case sensitivity functions of feedback loop.

---

### Example: ACC Two Cart Benchmark Problem

Returning to the “Example: ACC Benchmark Problem”, the closed loop system is

```
T=feedback(P*C,1); % closed-loop uncertain system
```

This uncertain state-space model `T` has three uncertain parameters, `k`, `m1` and `m2`, each equal to  $1 \pm 20\%$  uncertain variation. To analyze whether the closed-loop system `T` is robustly stable for all combinations of values for these three parameters, you can execute the commands

```
[StabilityMargin,Udestab,REPORT] = robuststab(T);
REPORT
```

This displays the REPORT

```
Uncertain System is robustly stable to modeled uncertainty.
-- It can tolerate up to 311% of modeled uncertainty.
-- A destabilizing combination of 500% the modeled uncertainty exists,
    causing an instability at 44.3 rad/s.
```

The report tells you that the control system is robust for all parameter variations in the  $\pm 20\%$  range, and that the smallest destabilizing combination of real variations in the values  $k$ ,  $m1$  and  $m2$  have sizes somewhere between  $311\%$  and  $500\%$  greater than  $\pm 20\%$ , i.e., between  $\pm 62.2\%$  and  $\pm 100\%$ . The value  $Udestab$  returns an estimate of the  $500\%$  destabilizing parameter variation combination:

```
Udestab =
    k: 1.2174e-005
    m1: 1.2174e-005
    m2: 2.0000.
```

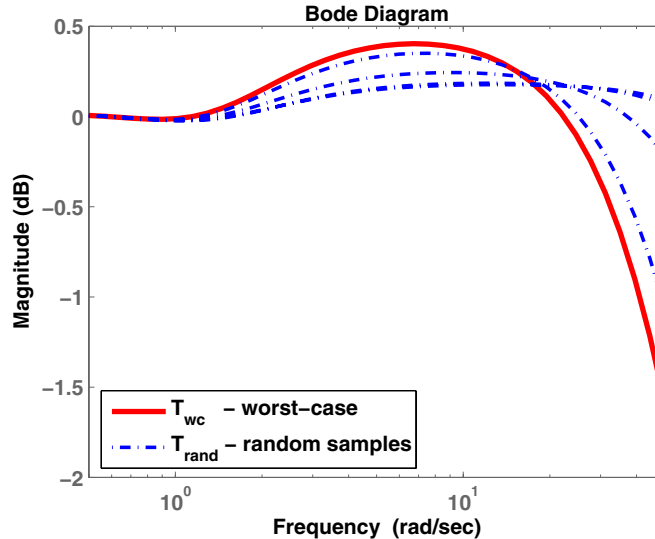

Figure 1-4: Uncertain system closed-loop bode plots.

You have a comfortable safety margin of between 311% to 500% larger than the anticipated  $\pm 20\%$  parameter variations before the closed-loop goes unstable. But, how much can closed-loop performance deteriorate for parameter variations constrained to lie strictly within the anticipated  $\pm 20\%$  range? The following code computes worst-case peak gain of T, and estimates the frequency and parameter values at which the peak gain occurs.

```
[PeakGain,Uwc] = wcgain(T);
Twc=usubs(T,Uwc);      % Worst case closed-loop system T
Trand=usample(T,4);    % 4 random samples of uncertain system T
bodemag(Twc,'r',Trand,'b-.',{.5,50}); % Do bode plot
legend('T_{wc} - worst-case',...
       'T_{rand} - random samples',3);
```

The resulting plot is shown in Figure 1-4.

## Synthesis of Robust MIMO Controllers

You can design controllers for Multi-Input-Multi-Output (MIMO) LTI models with your Robust Control Toolbox using following:

<b>Robust Control Synthesis Commands</b>	
h2hinfosyn	Mixed $H_2/H_\infty$ controller synthesis.
h2syn	$H_2$ controller synthesis.
hinfosyn	$H_\infty$ controller synthesis.
loopsyn	$H_\infty$ loop shaping controller synthesis
ltrsyn	Loop-transfer recovery controller synthesis
mixsyn	$H_\infty$ mixed-sensitivity controller synthesis.
ncfsyn	$H_\infty$ normalized coprime factor controller synthesis.
sdhinfosyn	Sampled-data $H_\infty$ controller synthesis.

### Example: Designing a Controller with LOOPSYN

One of the most powerful, yet simple controller synthesis tools is `loopsyn`. Given an LTI plant, you specify the shape of the open-loop systems frequency response plot that you want, then `loopsyn` computes a stabilizing controller that best approximates your specified loop shape.

For example, consider the 2×2 NASA HiMAT aircraft model (Safonov, Laub and Hartmann [8]) depicted in Figure 1-5. The control variables are elevon and canard actuators ( $\delta_e$  and  $\delta_c$ ). The output variables are angle of attack ( $\alpha$ ) and attitude angle ( $\theta$ ). The model has six states, viz.

$$x = \begin{bmatrix} x_1 \\ x_2 \\ x_3 \\ x_4 \\ x_5 \\ x_6 \end{bmatrix} = \begin{bmatrix} \dot{\alpha} \\ \alpha \\ \dot{\theta} \\ \theta \\ x_e \\ x_\delta \end{bmatrix} \quad \text{where } x_e \text{ and } x_\delta \text{ are elevator and canard actuator states.}$$

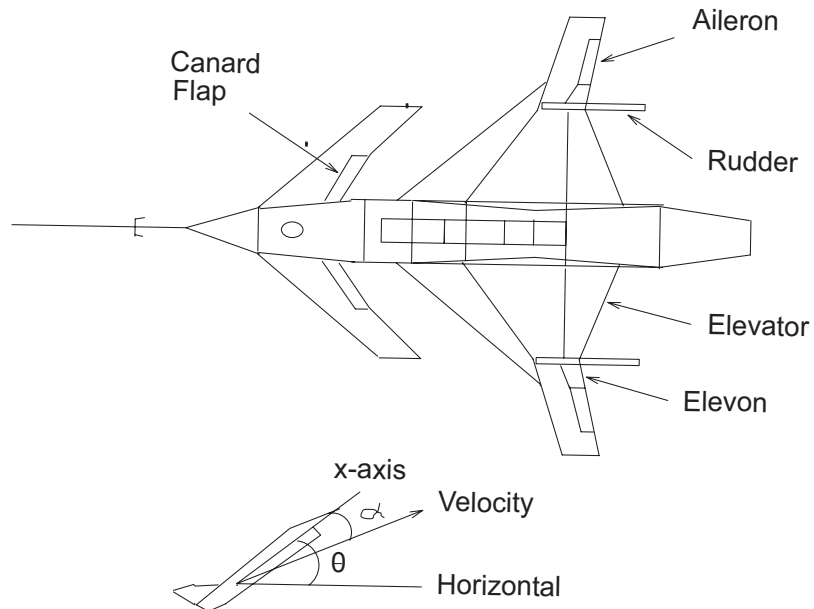

**Figure 1-5: Aircraft configuration and vertical plane geometry.**

You can enter the state-space matrices for this model with the following code:

```
% NASA HiMAT model G(s)
ag = [ -2.2567e-02  -3.6617e+01  -1.8897e+01  -3.2090e+01   3.2509e+00  -7.6257e-01;
       9.2572e-05  -1.8997e+00   9.8312e-01  -7.2562e-04  -1.7080e-01  -4.9652e-03;
       1.2338e-02   1.1720e+01  -2.6316e+00   8.7582e-04  -3.1604e+01   2.2396e+01;
       0           0   1.0000e+00           0           0           0;
       0           0           0           0  -3.0000e+01           0;
       0           0           0           0           0  -3.0000e+01];

bg = [ 0   0;
      0   0;
      0   0;
      0   0;
      30  0;
      0  30];

cg = [ 0   1   0   0   0   0;
      0   0   0   1   0   0];

dg = [ 0   0;
      0   0];

G=ss(ag,bg,cg,dg);
```

To design a controller to shape the frequency response (sigma) plot so that the system has approximately a bandwidth of 10 rad/s, you can set as your target desired loop shape  $G_d(s)=10/s$ , then use `loopsyn(G,Gd)` to find a loop-shaping controller for  $G$  that optimally matches the desired loop shape  $G_d$  by typing:

```
s=zpk('s'); w0=10; Gd=w0/(s+.001);
[K,CL,GAM]=loopsyn(G,Gd); % design a loopshaping controller K

% Plot the results
sigma(G*K,'r',Gd,'k-.',Gd/GAM,'k:',Gd*GAM,'k:',{.1,30})
figure ;T=feedback(G*K,eye(2));
sigma(T,ss(GAM),'k:',{.1,30});grid
```

The value of  $\gamma = \text{GAM}$  is returned is an indicator of the accuracy to which the optimal loop shape matches your desired loop shape and is an upper bound on the resonant peak magnitude of the closed-loop transfer function  $T=\text{feedback}(G*K,\text{eye}(2))$ . In this case,  $\gamma = 1.6024 = 4 \text{ db}$  — see Figure 1-6.

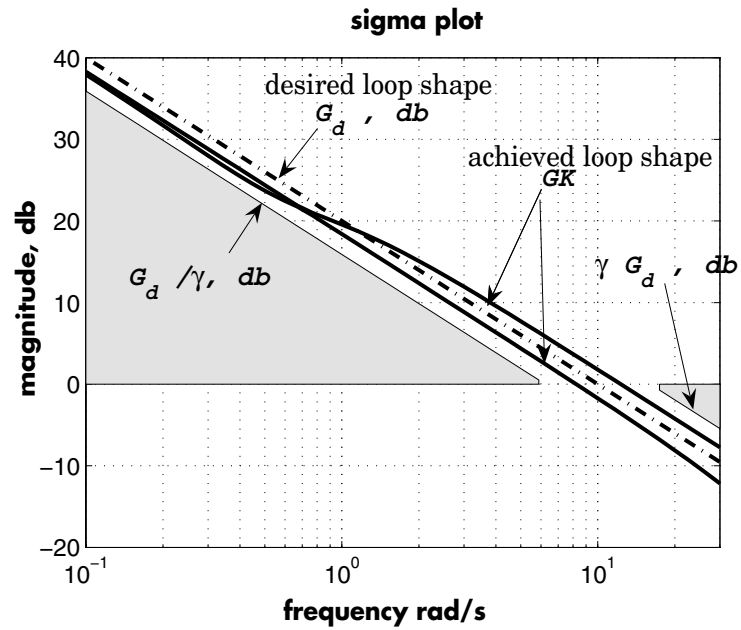

**Figure 1-6: MIMO robust loopshaping with `loopsyn(G, Gd)`.**

The achieved loop shape matches the desired target  $G_d$  to within about  $\gamma$ , db.

## Model Reduction and Approximation

Complex models are not always required for good control. Yet it is an unfortunate fact that optimization methods (including methods based on  $H_\infty$ ,  $H_2$  and  $\mu$ -synthesis optimal control theory) generally tend to produce controllers with at least as many states as the plant model. For this reason, the Robust Control Toolbox offers you an assortment of model-order reduction commands that help you to find less-complex, low-order approximations to plant and controller models.

---

### Model Reduction Commands

---

<code>reduce</code>	Main interface to model approximation algorithms
<code>balancmr</code>	Balanced truncation model reduction
<code>bstmr</code>	Balanced stochastic truncation model reduction.
<code>hankelmr</code>	Optimal Hankel norm model approximations
<code>modreal</code>	State-space modal truncation/realization
<code>ncfmr</code>	Balanced normalized coprime factor model reduction.
<code>schurmr</code>	Schur balanced truncation model reduction
<code>slowfast</code>	State-space slow-fast decomposition
<code>stabproj</code>	State-space stable/anti-stable decomposition
<code>imp2ss</code>	Impulse response to state-space approximation

---

Among the most important types of model reduction methods are minimize bounds on additive, multiplicative, and Normalized Coprime Factor (NCF) model-error. You can access all three of these methods using the command `reduce`.

### Example: NASA HiMAT Controller Order Reduction

For instance, the NASA HiMAT model considered in the last section has 8-states, and the optimal loopshaping controller turns out to have 16 states. Using model reduction, you can remove at least some of them without



appreciably affecting stability or closed-loop performance. For controller order reduction, the NCF model reduction is particularly useful, and it works equally well with controllers that have poles anywhere in the complex plane.

For the NASA HiMAT design in the last section, you can type

```
hankel sv(K, 'ncf', 'log');
```

which will display a logarithmic plot of the NCF hankel singular values—see Figure 1-8.

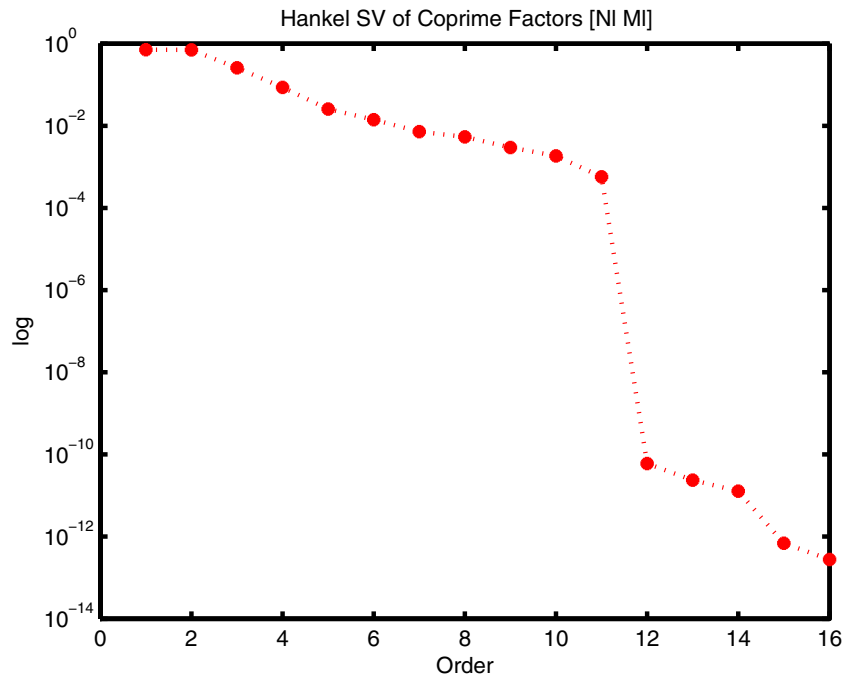
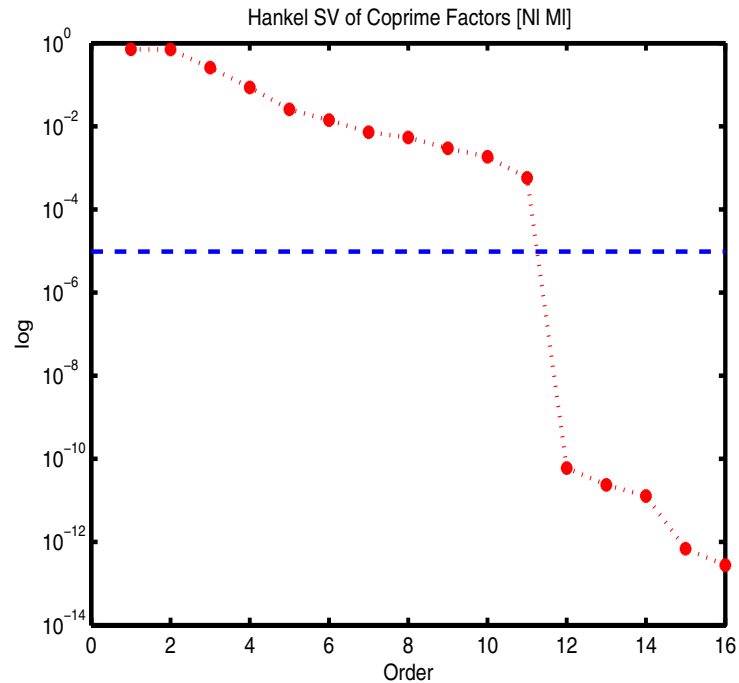

**Figure 1-7: Hankel Singular Values of Coprime Factorization of K.**

Theory says that, without danger of inducing instability, you can confidently discard at least those controller states that have NCF Hankel singular values that are much smaller than  $\text{ncfmargin}(G, K)$ .

Compute  $\text{ncfmargin}(G, K)$  and add it to your Hankel singular values plot.

```
hankelsv(K,'ncf','log');v=axis;
hold on; plot(v(1:2), ncfmargin(G,K)*[1 1], '--'); hold off
```



**Figure 1-8: Five of the 16 NCF hankel singular values of HiMAT controller K are small compared to  $\text{ncfmargin}(G,K)$ .**

In this case, you can safely discard 5 of the 16 states of K and compute an 11-state reduced controller by typing

```
K1=reduce(K,11,'errortype','ncf');
```

The result is plotted in Figure 1-9.

```
sigma(G*K1,'b',G*K,'r--',{.1,30});
```

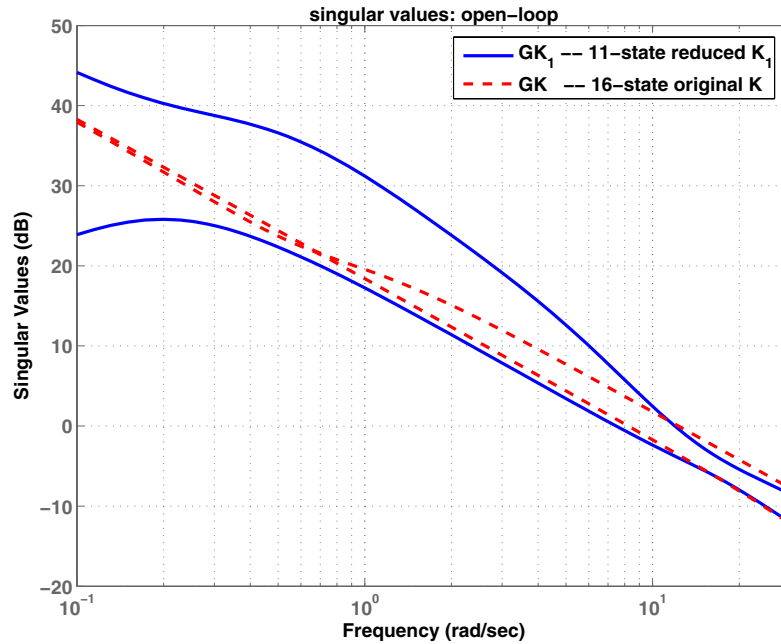

**Figure 1-9: HiMAT with 11-state controller  $K_1$  vs. original 16-state controller  $K$**

The picture above shows that low frequency gain is decreased considerably for inputs in one vector direction. Though this does not affect stability, it affects performance. If you wanted to better preserve low-frequency performance, you would discard fewer than 5 of the 16 states of  $K$ .

## LMI Solvers

At the core of many emergent robust control analysis and synthesis routines are powerful general purpose functions for solving a class of convex nonlinear programming problems known as Linear Matrix Inequalities. The LMI capabilities are invoked by Robust Control Toolbox functions that evaluate worst case performance, as well as functions like `hinf` and `h2hinf`. Some of main functions that help you access the LMI capabilities of the Robust Control Toolbox are shown in the table below:

<b>Specification of LMIs</b>	
<code>lmiedit</code>	GUI for LMI specification
<code>setlmi</code>	Initialize the LMI description
<code>lmivar</code>	Define a new matrix variable
<code>lmiterm</code>	Specify the term content of an LMI
<code>newlmi</code>	Attach an identifying tag to new LMIs
<code>getlmi</code>	Get the internal description of the LMI system
<b>LMI Solvers</b>	
<code>feasp</code>	Test feasibility of a system of LMIs
<code>gevp</code>	Minimize generalized eigenvalue with LMI constraints
<code>mincx</code>	Minimize of a linear objective with LMI constraints
<code>dec2mat</code>	Convert output of the solvers to values of matrix variables
<b>Evaluation of LMIs/Validation of Results</b>	
<code>evallmi</code>	Evaluate for given values of the decision variables
<code>showlmi</code>	Return the left- and right-hand sides of an evaluated LMI

Complete documentation is available in the on-line LMI LAB tutorial.

## Extends Control System Toolbox

The Robust Control Toolbox (RCT) is designed to work with the Control System Toolbox (CST). The RCT extends the capabilities of the CST and leverages off the LTI and plotting capabilities for the CST. The major analysis and synthesis commands in the RCT accept LTI object inputs, e.g., LTI state-space systems produced by commands such as

```
G=tf(1,[1 2 3])  
G=ss([-1 0; 0 -1], [1;1],[1 1],3).
```

The uncertain system (USS) objects in the RCT generalize the CST LTI SS objects and help ease the task of analyzing and plotting uncertain systems. You can do many of the same algebraic operations on uncertain systems that are possible for LTI objects (multiply, add, invert) and the RCT provides USS uncertain system extensions of CST interconnection and plotting functions like `feedback`, `lft` and `bode`.

## About the Authors

Prof. **Andy Packard** is with the Faculty of Mechanical Engineering at the University of California, Berkeley. His research interests include robustness issues in control analysis and design, linear algebra and numerical algorithms in control problems, applications of system theory to aerospace problems, flight control, and control of fluid flow.

Prof. **Gary Balas** is with the Faculty of the Aerospace Engineering & Mechanics at the University of Minnesota and is president of MUSYN Inc. His research interests include aerospace control systems, both experimental and theoretical.

Dr. **Michael Safonov** is with the Faculty of Electrical Engineering at the University of Southern California. His research interests include control and decision theory.

Dr. **Richard Chiang** is employed by Boeing Satellite Systems, El Segundo, CA. He is a Boeing Technical Fellow and has been working in aerospace industry over 25 years. In his career, Richard has designed three flight control laws, 12 spacecraft attitude control laws, and three large space structure vibration controllers using modern robust control theory and the tools he built in this toolbox. His research interests include robust control theory, model reduction and in-flight system identification. Working in industry instead of academia, Richard serves a unique role in our team, bridging the gap between theory and reality.

The Linear Matrix Inequality (LMI) portion of the Robust Control Toolbox was developed by these two authors:

Dr. **Pascal Gahinet** is employed by The MathWorks. His research interests include robust control theory, linear matrix inequalities, numerical linear algebra, and numerical software for control.

Prof. **Arkadi Nemirovski** is with the Faculty of Industrial Engineering and Management at Technion, Haifa, Israel. His research interests include convex optimization, complexity theory, and non-parametric statistics.

## Bibliography

- [1] S.P. Boyd and L. El Ghaoui and E. Feron and V. Balakrishnan, *Linear Matrix Inequalities in Systems and Control Theory*. Philadelphia, PA:SIAM, 1994.
- [2] P. Dorato (editor), *Robust Control*. New York: IEEE Press, 1987.
- [3] P. Dorato and R. K. Yedavalli (editors), *Recent Advances in Robust Control*. New York: IEEE Press, 1990.
- [4] J. C. Doyle and G. Stein, "Multivariable Feedback Design: Concepts for a Classical/Modern Synthesis," *IEEE Trans. on Automat. Contr.*, AC-26(1):4-16, 1981.
- [5] L. El Ghaoui and S. Niculescu, *Recent Advances in LMI Theory for Control*. Philadelphia, PA: SIAM. 2000.
- [6] N. A. Lehtomaki, N. R. Sandell, Jr., and M. Athans, "Robustness Results in Linear-Quadratic Gaussian Based Multivariable Control Designs," *IEEE Trans. on Automat. Contr.*, vol. AC-26, No. 1, pp. 75-92, Feb. 1981.
- [7] M. G. Safonov, *Stability and Robustness of Multivariable Feedback Systems*. Cambridge, MA: MIT Press, 1980.
- [8] M. G. Safonov, A. J. Laub, and G. Hartmann, "Feedback Properties of Multivariable Systems: The Role and Use of Return Difference Matrix," *IEEE Trans. of Automat. Contr.*, AC-26(1):47-65, 1981.
- [9] M. G. Safonov, R. Y. Chiang and H. Flashner, " $\mathbf{H}^\infty$  Control Synthesis for a Large Space Structure," *Proc. of American Contr. Conf.*, Atlanta, GA. June 15-17, 1988.
- [10] M. G. Safonov and R. Y. Chiang, "CACSD Using the State-Space  $\mathbf{L}^\infty$  Theory— A Design Example," *IEEE Trans. on Automatic Control*, AC-33(5):477-479, 1988.
- [11] R. S. Sanchez-Pena and M. Sznaier, *Robust Systems Theory and Applications*. New York: Wiley, 1998.
- [12] S. Skogestad and I. Postlethwaite", *Multivariable Feedback Control*. New York: Wiley, 1996.

[13] B. Wie and D. S. Bernstein, "A Benchmark Problem for Robust Controller Design," *Proc. American Control Conf.*, San Diego, CA May 23-25, 1990; also Boston, MA, June 26-28, 1991.

[14] K. Zhou, J. C. Doyle and K. Glover, *Robust and Optimal Control*. Englewood-Cliffs, NJ: Prentice Hall, 1996.



# Multivariable Loop Shaping

---

Tradeoff between Performance and Robustness (p. 2-2)	Singular values, disturbance attenuation and robustness
Typical loop shapes, S and T Design (p. 2-5)	Sigma plot design specifications (loop shape, sensitivity, and complementary sensitivity)
Using LOOPSYN to do H-Infinity Loop Shaping (p. 2-11)	Synthesis of MIMO $H_\infty$ optimal loopshaping controllers: LOOPSYN method and HiMAT aircraft example
Using MIXSYN for H-Infinity Loop Shaping (p. 2-18)	Synthesis of MIMO $H_\infty$ optimal loopshaping controllers: MIXSYN method and HiMAT aircraft example
Loop Shaping Commands (p. 2-21)	Summary of loop shaping commands and utilities

## Tradeoff between Performance and Robustness

When the plant modeling uncertainty is not too big, you can design high-gain, high-performance feedback controllers. High loop gains significantly larger than one in magnitude can attenuate the effects of plant model uncertainty and reduce the overall sensitivity of the system to plant noise. But if your plant model uncertainty is so large that you do not even know the sign of your plant gain, then you cannot use large feedback gains without the risk that the system will become unstable. Thus, plant model uncertainty can be a fundamental limiting factor in determining what can be achieved with feedback.

---

**Multiplicative Uncertainty:** Given an approximate model of the plant  $G_0$  of a plant  $G$ , the *multiplicative uncertainty*  $\Delta_M$  of the model  $G_0$  is defined as  $\Delta_M = G_0^{-1}(G - G_0)$  or, equivalently  $G = (I + \Delta_M)G_0$ .

---

Plant model uncertainty arises from many sources. There may be small unmodelled time-delays or stray electrical capacitance. Imprecisely understood actuator time constants, or, in mechanical systems, high frequency torsional bending modes, and similar effects can be responsible for plant model uncertainty. These types of uncertainty are relatively small at lower frequencies and typically increase at higher frequencies.

In the case of single-input-single-output (SISO) plants, the frequency at which there are uncertain variations in your plant of size  $|\Delta_M| = 2$  marks a critical threshold beyond which there is insufficient information about the plant to reliably design a feedback controller. With such a 200% model uncertainty, the model provides no indication of the phase angle of the true plant, which means that the only way you can reliably stabilize your plant is to ensure that the loop gain is less than one. Allowing for an additional factor of 2 margin for error, your control system bandwidth is essentially limited to the frequency range over which your multiplicative plant uncertainty  $\Delta_M$  has gain magnitude  $|\Delta_M| < 1$ .

## Norms and Singular Values

For MIMO systems the transfer functions are matrices and relevant measures of gain are determined by singular values,  $H_\infty$  and  $H_2$  norms — which are defined as follows:

---

**$H_2$  and  $H_\infty$  norms.** The  $H_2$ -norm is the energy of the impulse response of plant  $G$ . The  $H_\infty$ -norm is the peak gain of  $G$  across all frequencies and all input directions.

---

Another important concept is the notion of singular values.

---

**Singular Values:** The *singular values* of a rank  $r$  matrix  $A \in C^{m \times n}$ , denoted  $\sigma_i$ , are the non-negative square-roots of the eigenvalues of  $A^*A$  ordered such that  $\sigma_1 \geq \sigma_2 \geq \dots \geq \sigma_p > 0$ ,  $p \leq \min\{m, n\}$ .

If  $r < p$  then there are  $p - r$  zero singular values, i.e.,

$$\sigma_{r+1} = \sigma_{r+2} = \dots = \sigma_p = 0$$

then the greatest singular value  $\sigma_1$  is sometimes denoted  $\bar{\sigma}(A) = \sigma_1$ .

When  $A$  is a square  $n$ -by- $n$  matrix, then the  $n$ -th singular value (i.e., the least singular value) is denoted  $\underline{\sigma}(A) \triangleq \sigma_n$

---

### Properties of Singular Values

Some useful properties of singular values are

$$1 \quad \bar{\sigma}(A) = \max_{x \in C^n} \frac{\|Ax\|}{\|x\|}$$

$$2 \quad \underline{\sigma}(A) = \min_{x \in C^n} \frac{\|Ax\|}{\|x\|}$$

Properties 1 and 2 are especially important because they establish that the greatest and least singular values of a matrix  $A$  as the maximal and minimal “gains” of the matrix as the input vector “ $x$ ” varies over all possible directions.

For stable continuous-time LTI systems  $G(s)$ , the  $H_2$ -norm and the  $H_\infty$ -norms are defined in terms of the frequency-dependent singular values of  $G(j\omega)$ :

$$H_2\text{-norm: } \|G\|_2 = \Delta \left[ \frac{1}{2\pi} \int_{-\infty}^{\infty} \sum_{i=1}^p (\sigma_i(G(j\omega)))^2 d\omega \right]$$

$$H_\infty\text{-norm } \|G\|_\infty \triangleq \sup_{\omega} \bar{\sigma}(G(j\omega)) \quad (\text{sup: the least upper bound}):$$

## Typical loop shapes, S and T Design

Consider the multivariable feedback control system shown in Figure 2-1, Block diagram of the multivariable feedback control system. In order to quantify the multivariable stability margins and performance of such systems, you can use the singular values of the closed-loop transfer function matrices from  $r$  to each of the three outputs  $e$ ,  $u$  and  $y$ , viz.

$$S(s) \stackrel{\text{def}}{=} (I + L(s))^{-1}$$

$$R(s) \stackrel{\text{def}}{=} K(s)(I + L(s))^{-1}$$

$$T(s) \stackrel{\text{def}}{=} L(s)(I + L(s))^{-1} = I - S(s)$$

where the  $L(s)$  is the loop transfer function matrix

$$L(s) = G(s)K(s). \quad (2-1)$$

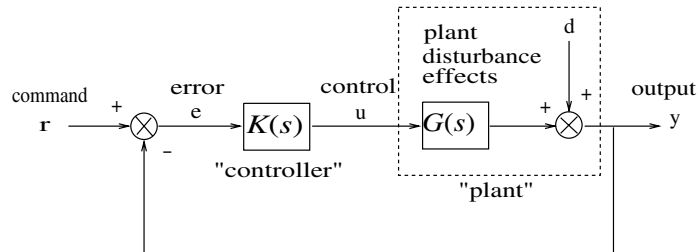

**Figure 2-1: Block diagram of the multivariable feedback control system.**

The two matrices  $S(s)$  and  $T(s)$  are known as the *sensitivity function* and *complementary sensitivity function*, respectively. The matrix  $R(s)$  has no common name. The singular value Bode plots of each of the three transfer function matrices  $S(s)$ ,  $R(s)$ , and  $T(s)$  play an important role in robust multivariable control system design. The singular values of the loop transfer function matrix  $L(s)$  are important because  $L(s)$  determines the matrices  $S(s)$  and  $T(s)$ .

### Singular Values

The singular values of  $S(j\omega)$  determine the disturbance attenuation since  $S(s)$  is in fact the closed-loop transfer function from disturbance  $d$  to plant output  $y$  — see *Figure 2-1*. Thus a disturbance attenuation performance specification may be written as

$$\bar{\sigma}(S(j\omega)) \leq |W_1^{-1}(j\omega)| \tag{2-2}$$

where  $|W_1^{-1}(j\omega)|$  is the desired disturbance attenuation factor. Allowing  $|W_1(j\omega)|$  to depend on frequency  $\omega$  enables you to specify a different attenuation factor for each frequency  $\omega$ .

The singular value Bode plots of  $R(s)$  and of  $T(s)$  are used to measure the stability margins of multivariable feedback designs in the face of additive plant perturbations  $\Delta_A$  and multiplicative plant perturbations  $\Delta_M$ , respectively. See *Figure 2-2*.

Let us consider how the singular value Bode plot of complementary sensitivity  $T(s)$  determines the stability margin for multiplicative perturbations  $\Delta_M$ . The multiplicative stability margin is, by definition, the “size” of the smallest stable  $\Delta_M(s)$  which destabilizes the system in *Figure 2-2* when  $\Delta_A = 0$ .

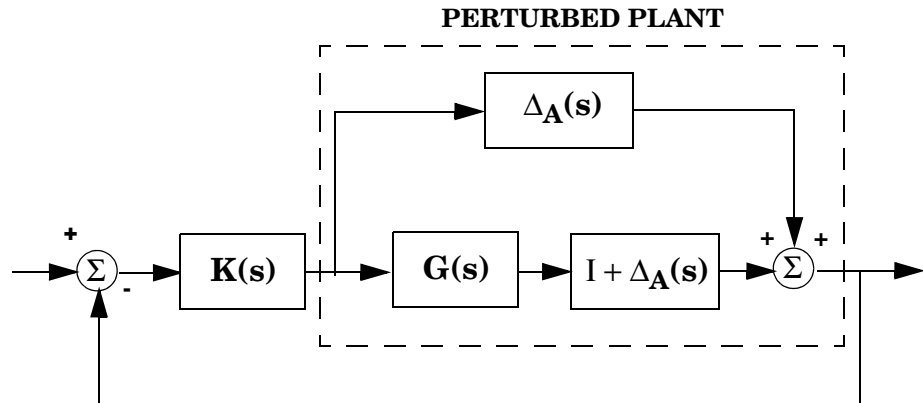

**Figure 2-2: Additive/Multiplicative uncertainty.**

Taking  $\bar{\sigma}(\Delta_M(j\omega))$  to be the definition of the “size” of  $\Delta_M(j\omega)$ , you have the following useful characterization of “multiplicative” stability robustness:

---

**Multiplicative Robustness** *The size of the smallest destabilizing multiplicative uncertainty  $\Delta_M(s)$  is*

$$\bar{\sigma}(\Delta_M(j\omega)) = \frac{1}{\bar{\sigma}(T(j\omega))}$$

---

The smaller is  $\bar{\sigma}(T(j\omega))$ , the greater will be the size of the smallest destabilizing multiplicative perturbation, and hence the greater will be the stability margin.

A similar result is available for relating the stability margin in the face of additive plant perturbations  $\Delta_A(s)$  to  $R(s)$  if we take  $\bar{\sigma}(\Delta_A(j\omega))$  to be our definition of the “size” of  $(\Delta_A(j\omega))$  at frequency  $\omega$ .

---

**Additive Robustness** *The size of the smallest destabilizing additive uncertainty  $\Delta_A$  is*

$$\bar{\sigma}(\Delta_A(j\omega)) = \frac{1}{\bar{\sigma}(R(j\omega))}$$

---

As a consequence of Robustness Theorems 1 and 2, it is common to specify the stability margins of control systems via singular value inequalities such as

$$\bar{\sigma}(R\{j\omega\}) \leq |W_2^{-1}(j\omega)| \tag{2-3}$$

$$\bar{\sigma}(T\{j\omega\}) \leq |W_3^{-1}(j\omega)| \tag{2-4}$$

where  $|W_2(j\omega)|$  and  $|W_3(j\omega)|$  are the respective sizes of the largest anticipated additive and multiplicative plant perturbations.

It is common practice to lump the effects of all plant uncertainty into a single fictitious multiplicative perturbation  $\Delta_M$ , so that the control design requirements may be written

$$\frac{1}{\underline{\sigma}_i(S(j\omega))} \geq |W_1(j\omega)|; \quad \bar{\sigma}_i(T[j\omega]) \leq |W_3^{-1}(j\omega)|$$

as shown in Figure 2-3.

It is interesting to note that in the upper half of Figure 2-3 (above the zero db line)

$$\underline{\sigma}(L(j\omega)) \approx \frac{1}{\bar{\sigma}(S(j\omega))}$$

while in the lower half of Figure 2-3 below the zero db line

$$\underline{\sigma}(L(j\omega)) \approx \bar{\sigma}(T(j\omega))$$

This results from the fact that

$$S(s) \stackrel{def}{=} (I + L(s))^{-1} \approx L(s)^{-1}, \quad \text{if } \underline{\sigma}(L(s)) \gg 1$$

$$T(s) \stackrel{def}{=} L(s)(I + L(s))^{-1} \approx L(s), \quad \text{if } \bar{\sigma}(L(s)) \ll 1$$



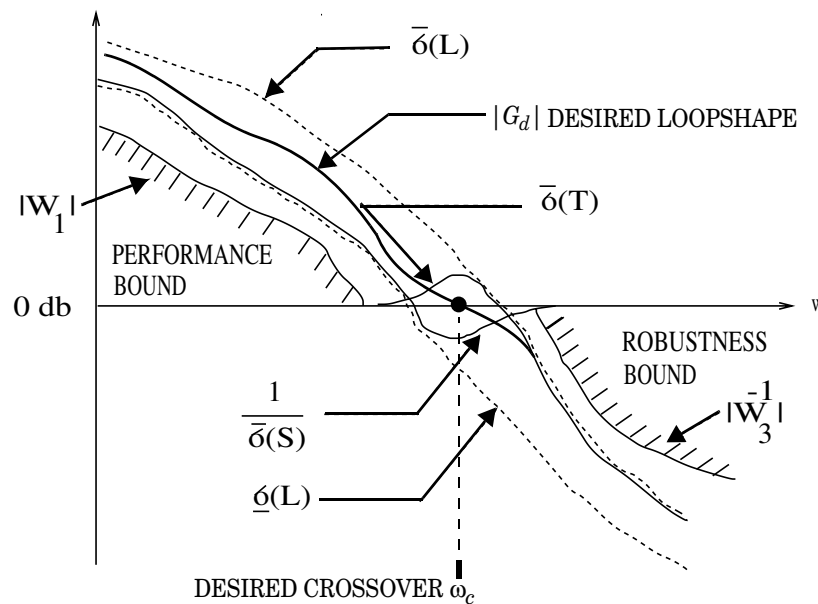

**Figure 2-3: Singular value specifications on  $L$ ,  $S$  and  $T$ .**

Thus, it is not uncommon to see specifications on disturbance attenuation and multiplicative stability margin expressed directly in terms of forbidden regions for the Bode plots of  $\sigma_i(L(j\omega))$  as “singular value loop shaping” requirements, either as specified upper/lower bounds or as a target desired loop shape — see Figure 2-3

## Guaranteed Gain/Phase Margins in MIMO Systems

For those who are more comfortable with classical single-loop concepts, there are the important connections between the multiplicative stability margins predicted by  $\bar{\sigma}(T)$  and those predicted by classical  $M$ -circles, as found on the Nichols chart. Indeed in the single-input-single-output case

$$\bar{\sigma}(T(j\omega)) = \left| \frac{L(j\omega)}{1 + L(j\omega)} \right|$$

which is precisely the quantity you obtain from Nichols chart  $M$ -circles. Thus,  $\|T\|_\infty$  is a multiloop generalization of the closed-loop resonant peak magnitude

which, as classical control experts will recognize, is closely related to the damping ratio of the dominant closed-loop poles. Also, it turns out that you may relate  $\|T\|_\infty$ ,  $\|S\|_\infty$  to the classical gain margin  $G_M$  and phase margin  $\theta_M$  in each feedback loop of the multivariable feedback system of Figure 2-1, Block diagram of the multivariable feedback control system. via the formulae [6]

$$G_M \geq 1 + \frac{1}{\|T\|_\infty}$$

$$G_M \geq 1 + \frac{1}{1 - 1/\|S\|_\infty}$$

$$\theta_M \geq 2 \sin^{-1} \left( \frac{1}{2\|T\|_\infty} \right)$$

$$\theta_M \geq 2 \sin^{-1} \left( \frac{1}{2\|S\|_\infty} \right).$$

These formula are valid provided  $\|S\|_\infty$  and  $\|T\|_\infty$  are larger than one, as is normally the case. The margins apply even when the gain perturbations or phase perturbations occur simultaneously in several feedback channels.

The infinity norms of  $S$  and  $T$  also yield gain reduction tolerances. The *gain reduction tolerance*  $g_m$  is defined to be the minimal amount by which the gains in each loop would have to be *decreased* in order to destabilize the system.

Upper bounds on  $g_m$  are

$$g_m \leq 1 - \frac{1}{\|T\|_\infty}$$

$$g_m \leq \frac{1}{1 + 1/\|S\|_\infty}$$

## Using LOOPSYN to do H-Infinity Loop Shaping

The command `loopsyn` lets you design a stabilizing feedback controller to optimally shape the open loop frequency response of MIMO feedback control system to match as closely as possible a desired loop shape  $G_d$ —see Figure 2-3. The basic syntax of the `loopsyn` loopshaping controller synthesis command is

$$K = \text{LOOPSYN}(G, G_d)$$

Here  $G$  is the LTI transfer function matrix of a MIMO plant model,  $G_d$  is the target desired loop shape for the loop transfer function  $L=G*K$ , and  $K$  is the optimal loop shaping controller. The LTI controller  $K$  has the property that it shapes the loop  $L=G*K$  so that it matches the frequency response of  $G_d$  as closely as possible, subject to the constant that the must stabilize the plant model  $G$ .

### Example: NASA HiMAT loop-shaping

To see how the `loopsyn` command works in practice to address robustness and performance tradeoffs, let's consider again the NASA HiMAT aircraft model taken from the paper of Safonov, Laub and Hartmann [8]. The longitudinal dynamics of the HiMAT aircraft trimmed at 25000 ft and 0.9 Mach are unstable and have two right half plane phugoid modes. The linear model has state-space realization  $G(s) = C(Is - A)^{-1}B$  with 6 states, with the first four states representing angle of attack ( $\alpha$ ) and attitude angle ( $\theta$ ) and their rates of change, and the last two representing elevon and canard control actuator dynamics—see Figure 2-4.

```
ag = [
-2.2567e-02  -3.6617e+01  -1.8897e+01  -3.2090e+01   3.2509e+00  -7.6257e-01;
 9.2572e-05  -1.8997e+00   9.8312e-01  -7.2562e-04  -1.7080e-01  -4.9652e-03;
 1.2338e-02   1.1720e+01  -2.6316e+00   8.7582e-04  -3.1604e+01   2.2396e+01;
 0            0         1.0000e+00         0            0            0;
 0            0            0            0        -3.0000e+01         0;
 0            0            0            0            0        -3.0000e+01];
bg = [0  0;
      0  0;
      0  0;
      0  0;
      30 0;
      0 30];
cg = [0  1  0  0  0  0;
      0  0  0  1  0  0];
dg = [0  0;
      0  0];
G=ss(ag,bg,cg,dg);
```

The control variables are elevon and canard actuators ( $\delta_e$  and  $\delta_c$ ). The output variables are angle of attack ( $\alpha$ ) and attitude angle ( $\theta$ ).

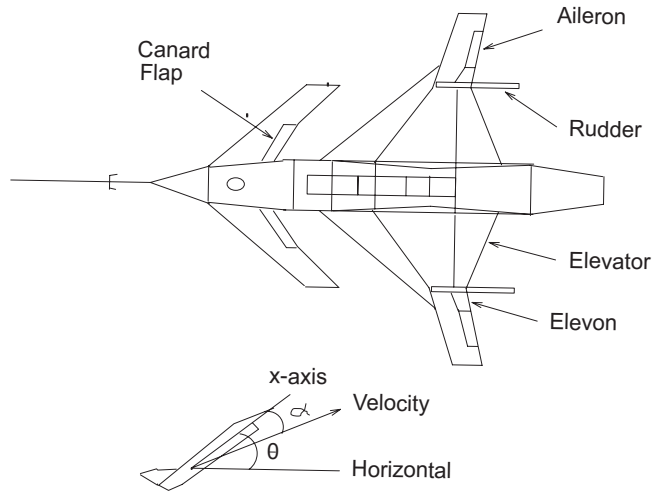

**Figure 2-4: Aircraft configuration and vertical plane geometry.**

This model is good at frequencies below 100 rad/s with less than 30% variation between the true aircraft and the model in this frequency range. However as noted in [8], it does not reliably capture very high frequency behaviors, since it was derived by treating the aircraft as a rigid body and neglecting lightly damped fuselage bending modes that occur at somewhere between 100 and 300 rad/sec. These unmodelled bending modes might cause as much as 20 db deviation (i.e., 1000%) between the frequency response of the model and the actual aircraft for frequency  $\omega > 100$  rad/sec. Other effects like control actuator time-delays and fuel sloshing also contribute to model inaccuracy at even higher frequencies, but the dominant unmodelled effects are the fuselage bending modes. You can think of these unmodelled bending modes as multiplicative uncertainty of size 20db, and design your controller using loopsyn, by making sure that the loop has gain less than -20 db at, and beyond, the frequency  $\omega > 100$  rad/sec.

## Design Specifications

The singular value design specifications are:

- 1 Robustness Spec.:**  $-20$  db/decade roll-off slope and  $-20$  db loop-gain at  $100$  rad/sec
- 2 Performance Spec.:** Maximize the sensitivity function as much as possible.

Both specs can be accommodated by taking as the desired loop shape

$$G_d(s) = 8/s.$$

## MATLAB Commands for a LOOPSYN design

```
%% Enter the desired loop shape Gd
s=zpk('s'); % Laplace variable s
Gd=8/s; % desired loop shape

%% Compute the optimal loop shaping controller K
[K,CL,GAM]=loopsyn(G,Gd);

%% Compute the loop L, sensitivity S and
%% complementary sensitivity T:
L=G*K;
I=eye(size(L));
S=feedback(I,L); % S=inv(I+L);
T=I-S;

%% Plot the results:
% step response plots
step(T);title('\alpha and \theta command step responses');

% frequency response plots
figure;
sigma(I+L,'--',T,':',L,'r--',Gd,'k-',Gd/GAM,'k:',...
    Gd*GAM,'k:',{.1,100});grid
legend('1/\sigma(S) performance',...
    '\sigma(T) robustness',...
    '\sigma(L) loopshape',...
    '\sigma(Gd) desired loop',...
    '\sigma(Gd) \pm GAM, db');
```

The plots of the resulting step and frequency response for the NASA HiMAT loopsyn loop shaping controller design are shown in below in Figure 2-6. The number  $\pm \text{GAM, db}$  (i.e.,  $20\log_{10}(\text{GAM})$ ) tells you the accuracy that your loopsyn control design matches the target desired loop:

$$\bar{\sigma}(GK), \text{ db} \geq |G_d|, \text{ db} - \text{GAM, db} \quad \text{for } \omega < \omega_c$$

$$\bar{\sigma}(GK), \text{ db} \leq |G_d|, \text{ db} + \text{GAM, db} \quad \text{for } \omega > \omega_c.$$

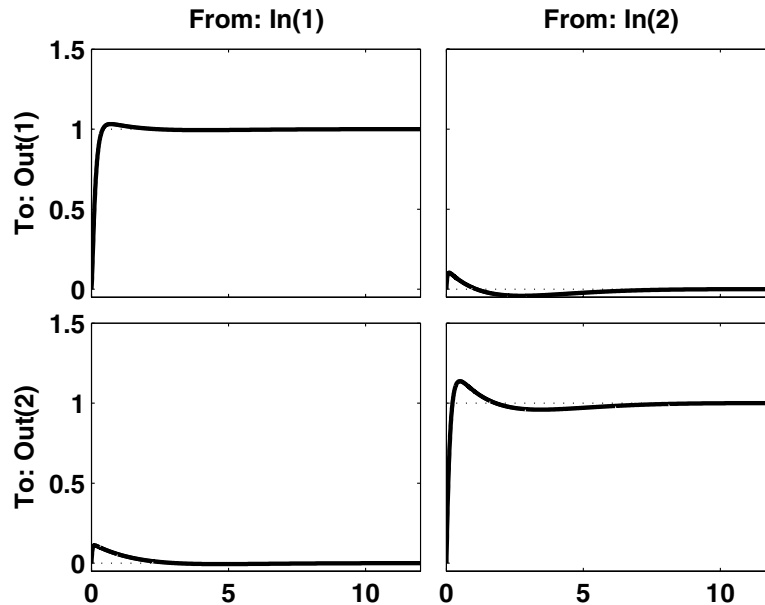

**Figure 2-5: HiMAT closed loop step responses**

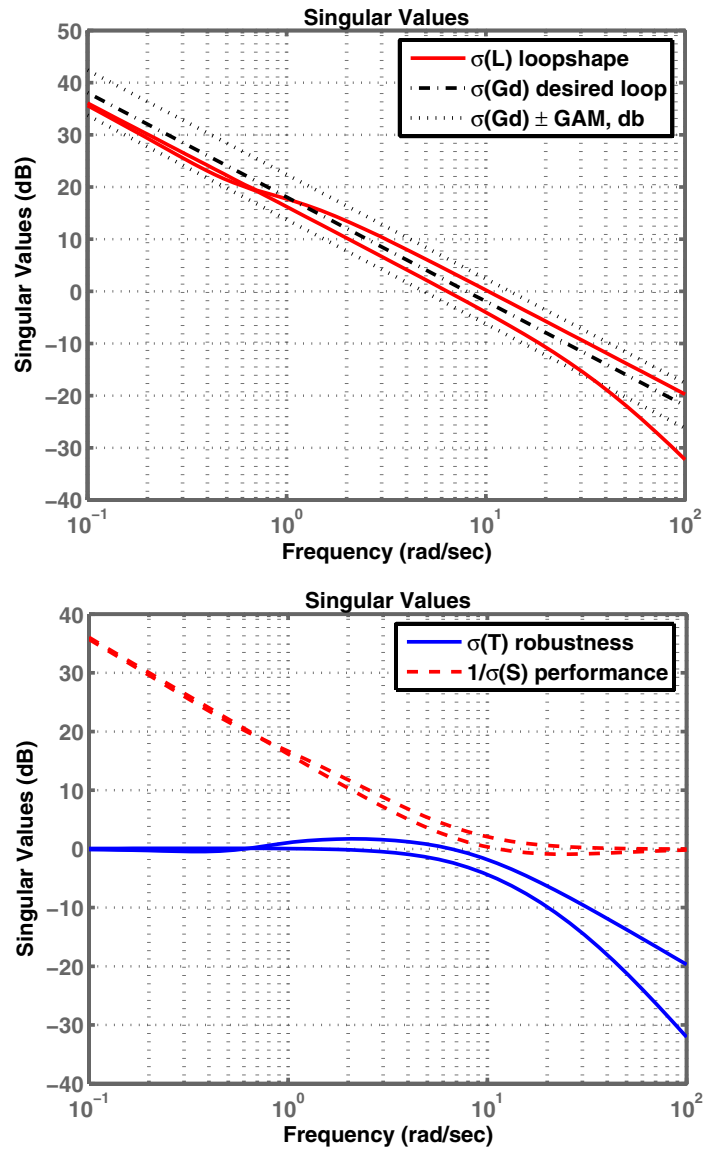

Figure 2-6: LOOPSYN design results for NASA HiMAT

### Fine tuning the LOOPSYN target loop shape $G_d$ to meet design goals.

If your first attempt at loopshaping design does not achieve everything you wanted, you will need to re-adjust your target desired loop shape  $G_d$ . Here are some basic design trade-offs to consider:

- 1 Stability Robustness.** Your target loop  $G_d$  should have low gain (as small as possible) at high frequencies where typically your plant model is so poor that your its phase angle is completely inaccurate with errors approaching  $\pm 180^\circ$  or more.
- 2 Performance.** Your loop  $G_d$  loop should have high gain (as great as possible) at frequencies where your model is good in order to assure good control accuracy and good disturbance attenuation.
- 3 Crossover and Roll-Off.** Your desired loop shape  $G_d$  should have its 0db crossover frequency (denoted  $\omega_c$ ) between the above two frequency ranges and, below the crossover frequency  $\omega_c$ , it should roll-off with a negative slope of between -20 and -40 db/decade, which helps to keep phase lag to less than  $-180^\circ$  inside the control loop bandwidth ( $0 < \omega < \omega_c$ ).

Other considerations that might affect your choice of  $G_d$  are the right-half-plane poles and zeros of the plant  $G$ , which impose fundamental limits on your 0db crossover frequency  $\omega_c$  [12]. For instance, your 0db crossover  $\omega_c$  must be greater than the magnitude of any plant right-half-plane poles and less than the magnitude of any right-half-plane zeros. If do not take care to

$$\max_{\text{Re}(p_i) > 0} |p_i| < \omega_c < \min_{\text{Re}(z_i) > 0} |z_i|.$$

choose target loop shape  $G_d$  that conforms to these fundamental constraints, then loopshaping will still compute the optimal loopshaping controller  $K$  for your  $G_d$  but you should expect that the optimal loop  $L=G*K$  will have a poor fit to the



target loop shape  $G_d$  and consequently it may be impossible to meet your performance goals.

## Using MIXSYN for H-Infinity Loop Shaping

A popular alternative approach to loopsyn loop-shaping is the  $H_\infty$  *mixed-sensitivity* loop-shaping, which is implemented by the Robust Control Toolbox command

$$K = \text{mixsyn}(G, W_1, [], W_3)$$

With `mixsyn` controller synthesis, your performance and stability robustness specifications equations (2-2) and (2-4) are combined into a single infinity norm specification of the form

$$\|T_{y_1 u_1}\|_\infty \leq 1$$

where (see Figure 2-7)

$$T_{y_1 u_1} \stackrel{\text{def}}{=} \begin{bmatrix} W_1 S \\ W_3 T \end{bmatrix}.$$

The term  $\|T_{y_1 u_1}\|_\infty$  is called a *mixed-sensitivity cost function* because it penalizes both sensitivity  $S(s)$  and complementary sensitivity  $T(s)$ . Loop shaping is achieved when you choose  $W_1$  to have the target loop shape for frequencies  $\omega < \omega_c$ , and you choose  $1/W_3$  to be the target for  $\omega > \omega_c$ . In choosing design specifications  $W_1$  and  $W_3$  for a `mixsyn` controller design, you need to take care to be sure that your 0 db crossover frequency for the Bode plot of  $W_1$  is below the 0 db crossover frequency of  $1/W_3$  as shown in Figure 2-3, so that there is a gap for the desired loop shape  $G_d$  to pass between the performance bound

$W_1$  and your robustness bound  $W_3^{-1}$ . Otherwise, or your performance and robustness requirements will not be achievable.

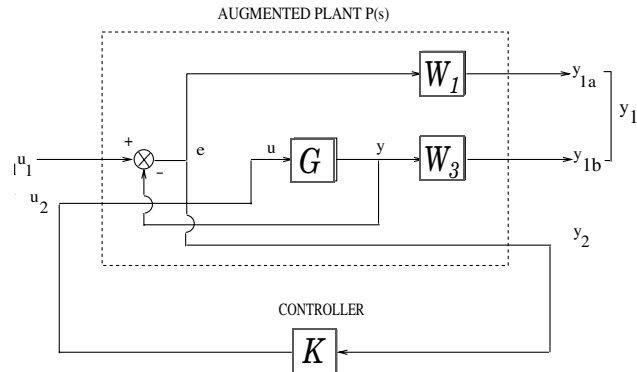

**Figure 2-7: MIXSYN  $H_\infty$  mixed-sensitivity loopshaping  $T_{y1u1}$ .**

## Example: NASA HiMAT design using MIXSYN

To do a mixsyn  $H_\infty$  mixed-sensitivity synthesis design on the HiMAT model, start with the plant model  $G$  created in “Example: NASA HiMAT loop-shaping” on page 2-11 and type the following commands:

```
% Set up the performance and robustness bounds W1 & W3
s=zpk('s'); % Laplace variable s
MS=2;AS=.03;WS=5;
W1=(s/MS+WS)/(s+AS*WS);
MT=2;AT=.05;WT=20;
W3=(s+WT/MT)/(AT*s+WT);

% Compute the H-infinity mixed-sensitivity optimal controller K1
[K1,CL1,GAM1]=mixsyn(G,W1,[],W3);

% Next compute and plot the closed-loop system.
% Compute the loop L1, sensitivity S1 and comp sensitivity T1:
L1=G*K1;
I=eye(size(L1));
S1=feedback(I,L1); % S=inv(I+L1);
T1=I-S1;

% Plot the results:
```

```

% step response plots
step(T1,1.5);
title('\alpha and \theta command step responses');

% frequency response plots
figure;
sigma(I+L1,'--',T1,':',L1,'r--',...
W1/GAM1,'k--',GAM1/W3,'k-.',{.1,100});grid
legend('1/\sigma(S) performance',...
'\sigma(T) robustness',...
'\sigma(L) loopshape',...
'\sigma(W1) performance bound',...
'\sigma(1/W3) robustnes bound');

```

The resulting mixsyn singular value plots for the are shown below.

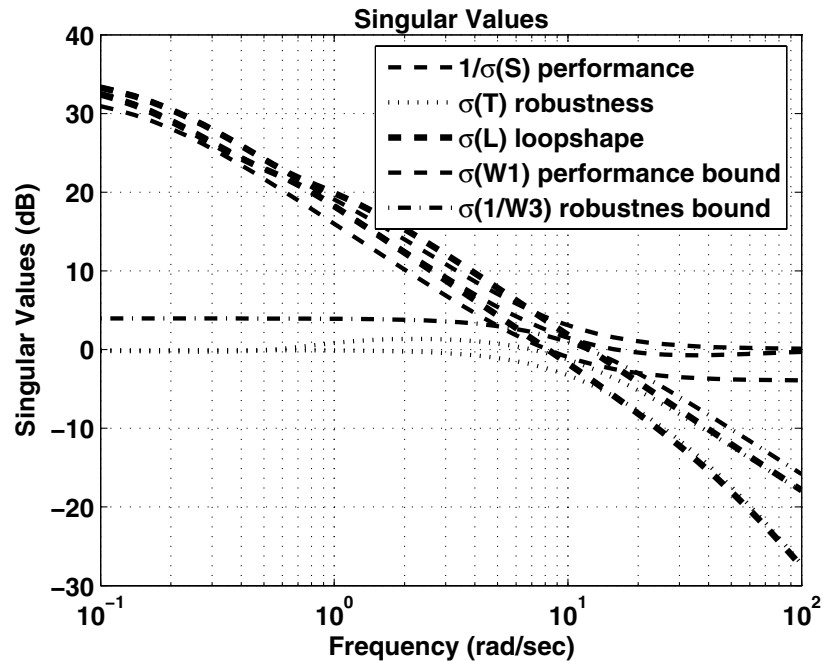

**Figure 2-8: MIXSYN design results for NASA HiMAT**

## Loop Shaping Commands

The Robust Control Toolbox gives you several choices for shaping the frequency response properties of multi-input-multi-output (MIMO) feedback control loops. Some of the main commands that you are likely to use for loop shaping design, and associated utility functions, are listed below::

<b>MIMO loop shaping commands</b>	
loopsyn	$H_\infty$ loop shaping controller synthesis
ltrsyn	LQG loop-transfer recovery
mixsyn	$H_\infty$ mixed-sensitivity controller synthesis
ncfsyn	Glover-McFarlane $H_\infty$ normalized coprime factor loop shaping controller synthesis

<b>MIMO loop shaping utility functions</b>	
augw	Augmented plant for weighted $H_2$ and $H_\infty$ mixed sensitivity control synthesis
makeweight	Weights for H-infinity mixed sensitivity (mixsyn, augw)
sigma	Singular value plots of LTI feedback loops



# Model Reduction for Robust Control

---

Introduction (p. 3-2)	Motivations, Hankel singular values
Overview of Model Reduction Techniques (p. 3-4)	Hankel singular value based model reduction routines and their Error Bounds
Approximating Plant Models -- Additive Error Methods (p. 3-6)	Robust Frequency. Rigid body dynamics. Large size plant. Examples.
Approximating Plant Models -- Multiplicative Error Method (p. 3-8)	The multiplicative error method is presented, followed by a comparison between additive and multiplicative methods
Using Modal Algorithms (p. 3-10)	How to keep the $j\omega$ -axis poles of a plant during model reduction
Reducing Large Scale Models (p. 3-13)	Strategies for reducing very large plant models
Using Normalized Coprime Factor Methods (p. 3-14)	Model order reduction examples
References (p. 3-15)	Sources for model reduction theory

## Introduction

In the design of robust controllers for complicated systems, model reduction arises in several places:

- 1 It is desirable to simplify the best available model in light of the purpose to which the model is to be used — namely, to design a control system to meet certain specifications.
- 2 To speed up the simulation process in design validation stage, using a smaller size model with most of the system important dynamics preserved is highly desirable.
- 3 Finally, if a modern control method such as LQG or  $H^\infty$  is employed for which the complexity of the control law is not explicitly constrained, the order of the resultant controller is likely to be considerably greater than is truly needed. A good model reduction algorithm applied to the control law can sometimes significantly reduce control law complexity with little change in control system performance.

Model reduction routines in this toolbox can be put into two categories:

- 1 **Additive error method:** reduced order model has an additive error bounded by an error criterion.
- 2 **Multiplicative error method:** reduced order model has a multiplicative or relative error bounded by an error criterion.

The error is measured in terms of peak gain across frequency ( $H_\infty$  norm) and the error bounds are a function of the neglected Hankel singular values.

## Hankel Singular Values

In control theory, eigenvalues define a system stability, whereas *Hankel singular values* define the “energy” of each state in the system. Keeping larger “energetic” states of a system preserves most of its characteristics in terms of stability, frequency and time responses. Model reduction techniques presented here are all based on the Hankel singular values of a system. They can achieve a reduced order model that preserves the majority of the system characteristics.



Mathematically, given a *stable* state-space system  $(A,B,C,D)$ , its Hankel singular values are defined as [1]

$$\sigma_H = \sqrt{\lambda_i(PQ)}$$

where  $P$  and  $Q$  are *Controllability* and *Observability Grammians* satisfying

$$AP + PA^T = -BB^T$$

$$A^T Q + QA = -C^T C$$

For example,

```
rand('state',1234); randn('state',5678);
G = rss(30,4,3);
hankelsv(G)
```

returns a Hankel singular value plot as follows

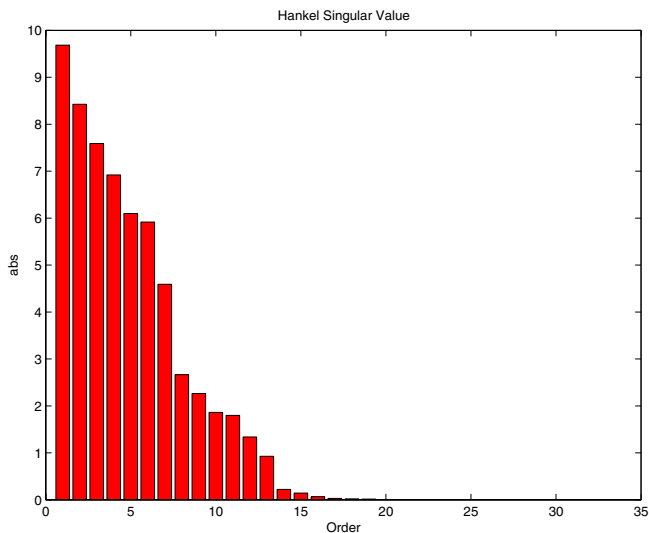

which shows that system  $G$  has most of its “energy” stored in states 1 through 15 or so. We will show later on using model reduction routines to keep a 15-state reduced model will preserve most of its dynamic response.

## Overview of Model Reduction Techniques

The Robust Control Toolbox offers several algorithms for model approximation and order reduction. These algorithms let you control the absolute or relative approximation error, and are all based on the Hankel singular values of the system.

As discussed in previous sections, robust control theory quantifies a system uncertainty as either *Additive* or *Multiplicative* types. These model reduction routines are also categorized into two groups: *Additive Error* and *Multiplicative Error* types. In other words, some model reduction routines produce a reduced order model  $G_{red}$  of the original model  $G$  with a bound on the error  $\|G - G_{red}\|_{\infty}$ , the peak gain across frequency. Others produce a reduced order model with a bound on the relative error  $\|G^{-1}(G - G_{red})\|_{\infty}$ .

These theoretical bounds are based on the “tails” of the Hankel Singular Values of the model, i.e.,

### Additive Error Bound: [1]

$$\|G - G_{red}\|_{\infty} \leq 2 \sum_{k=1}^n \sigma_k$$

where  $\sigma_i$  are denoted the  $i^{th}$  Hankel singular value of the original system  $G$ .

### Multiplicative (Relative) Error Bound: [2]

$$\|G^{-1}(G - G_{red})\|_{\infty} \leq \prod_{k=1}^n (1 + 2\sigma_k(\sqrt{1 + \sigma_k^2} + \sigma_k)) - 1$$

where  $\sigma_i$  are denoted the  $i^{th}$  Hankel singular value of the phase matrix of the model  $G$  (see reference page on `bstmr`).

**Table 3-1: Top Level Model Reduction Command**

Method	Description
reduce	Main interface to model approximation algorithms

**Table 3-2: Normalized Coprime Balanced Model Reduction command**

<b>Method</b>	<b>Description</b>
ncfmr	Normalized coprime balanced truncation

**Table 3-3: Additive Error Model Reduction commands**

<b>Method</b>	<b>Description</b>
balancmr	Square-root balanced model truncation
schurmr	Schur balanced model truncation
hankelmr	Hankel minimum degree approximation

**Table 3-4: Multiplicative Error Model Reduction command**

<b>Method</b>	<b>Description</b>
bstmr	Balanced stochastic truncation

**Table 3-5: Additional Model Reduction Tools**

<b>Method</b>	<b>Description</b>
modreal	Modal realization and truncation
slowfast	Slow and fast state decomposition
stabproj	Stable and anti-stable state projection

## Approximating Plant Models -- Additive Error Methods

Given a system in LTI form, the following commands reduce the system to any desired order as one specifies. The judgement call has based on its Hankel Singular Values as shown in previous paragraph.

```
rand('state',1234); randn('state',5678);
G = rss(30,4,3);
% balanced truncation to models with sizes 12:16
[g1,info1] = balancmr(G,12:16); % or use reduce
% Schur balanced truncation by specifying `MaxError`
[g2,info2] = schurmr(G,'MaxError',[1,0.8,0.5,0.2]);
sigma(G,'b-',g1,'r-',g2,'g-.')
```

shows a comparison plot of the original model G, reduced models g1 and g2.

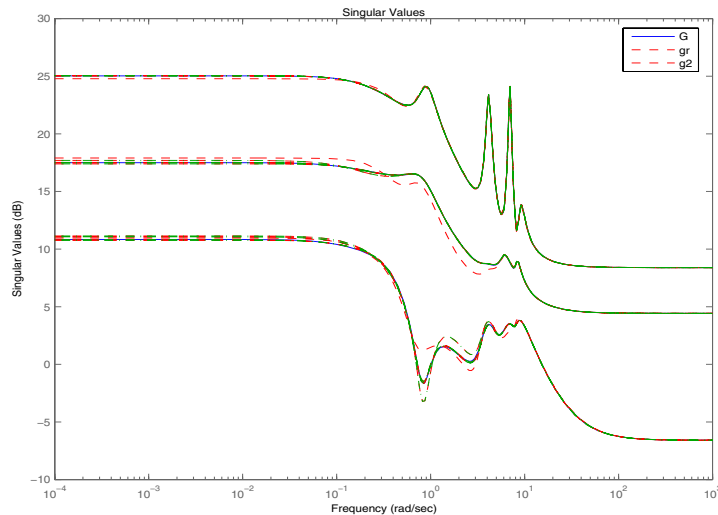

To check whether the theoretical error bound is satisfied:

```
norm(G-g1(:, :, 1), 'inf') % 2.0123
info1.ErrorBound(1) % 2.8529
```

or plot the model error vs. error bound via the following commands

```
[sv,w] = sigma(G-g1(:,:,1));  
loglog(w,sv,w,info1.ErrorBound(1)*ones(size(w)))  
xlabel('rad/sec');ylabel('SV');  
title('Error Bound and Model Error')
```

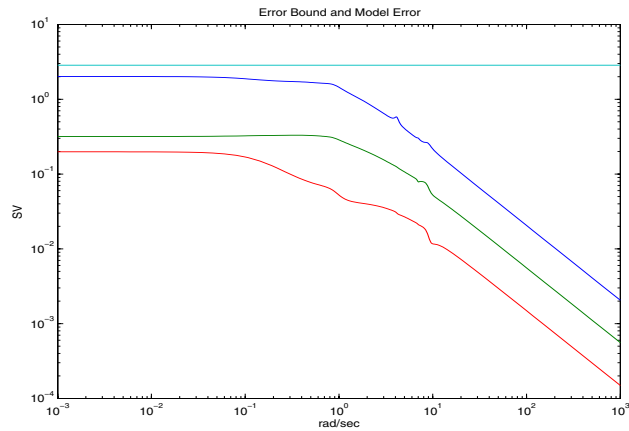

## Approximating Plant Models -- Multiplicative Error Method

In most cases, *Multiplicative Error* model reduction method `bstmr` tends to bound the relative error between the original and reduced order models across the frequency range of interests, hence producing more accurate reduced order model than the *Additive Error* methods. This characteristics is obviously shown in system models with low damped poles.

The following commands illustrate the significance of a multiplicative error model reduction method as compared to any additive error type. Clearly the phase matching algorithm using `bstmr` provides a better fit in the Bode plot.

```
rand('state',1234); randn('state',5678); G = rss(30,1,1);
[gr,infor] = reduce(G,'algo','balance','order',7);
[gs,infos] = reduce(G,'algo','bst','order',7);
figure(1);bode(G,'b-',gr,'r--');
title('Additive Error Method')
figure(2);bode(G,'b-',gs,'r--');
title('Relative Error Method')
```

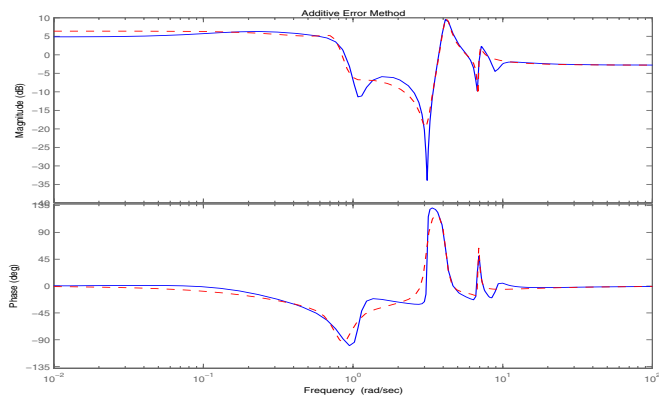

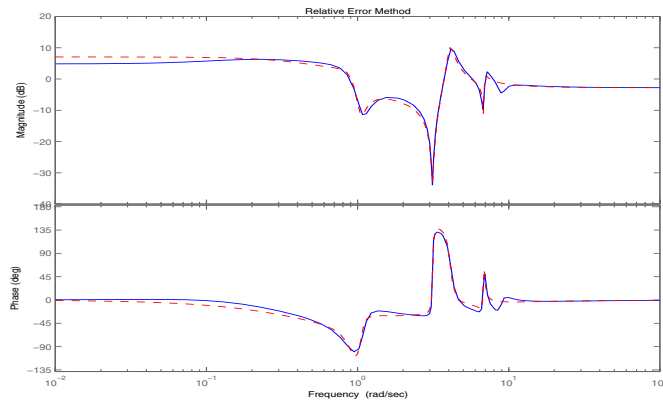

Therefore, for some systems with low damped poles/zeros, Balanced Stochastic Method (bstmr) produces a better reduced order model fit in those frequency range to make multiplicative error small. Whereas additive error methods such as balancmr, schurmr, or hanke1mr only care about minimizing the overall “absolute” peak error, may produce a reduced order model missing those low damped poles/zeros frequency regions.

## Using Modal Algorithms

### Rigid Body Dynamics

In many cases, a model's  $j\omega$ -axis poles are important to keep after model reduction, e.g., rigid body dynamics of a flexible structure plant or integrators of a controller, then a unique routine `modreal` serves the purpose nicely.

`modreal` puts a system into its *Modal Form* with eigenvalues appearing on the diagonal of its A-matrix. Real eigenvalues will appear in 1x1 blocks, and complex eigenvalues will appear in 2x2 real blocks. All the blocks will be ordered in ascending order based on their eigenvalues magnitudes by default or descending order based on their real parts. Therefore, specifying the number of  $j\omega$ -axis poles splits the model into two systems with one containing only  $j\omega$ -axis dynamics, the other containing the non- $j\omega$  axis dynamics.

```
rand('state',5678); randn('state',1234); G = rss(30,1,1);
[Gjw,G2] = modreal(G,1); % only one rigid body dynamics
G2.d = Gjw.d; Gjw.d = 0; % put DC gain of G into G2
subplot(211);sigma(Gjw);ylabel('Rigid Body')
subplot(212);sigma(G2);ylabel('Non-Rigid Body')
```

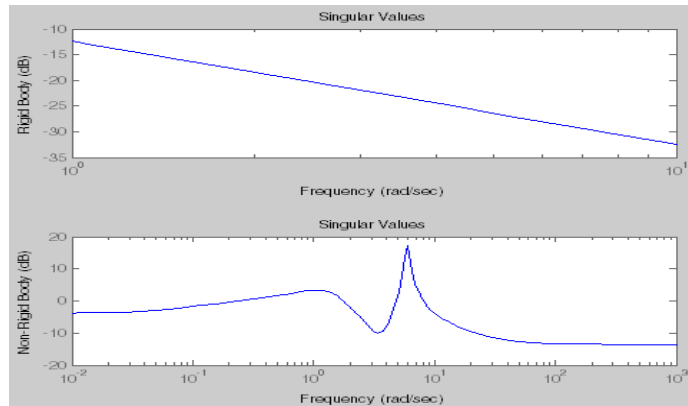

Further model reduction can be done on `G2` without any numerical difficulty. After `G2` is further reduced to `Gred`, the final approximation of the model is simply `Gjw+Gred`.



This process of splitting  $j\omega$ -axis poles has been built-in and automated in all the model reduction routines (`balancmr`, `schurmr`, `hankelmr`, `bstmr`, `hankelsv`) so that users need not to worry about splitting the model to begin with.

The following single command creates a size 8 reduced order model from its original 30-state model:

```
rand('state',5678); randn('state',1234); G = rss(30,1,1);  
[gr,info] = reduce(G); % choose a size of 8 at prompt  
bode(G, 'b- ',gr, 'r--')
```

Without specifying the size of the reduced order model, a Hankel singular value plot will be shown as follows

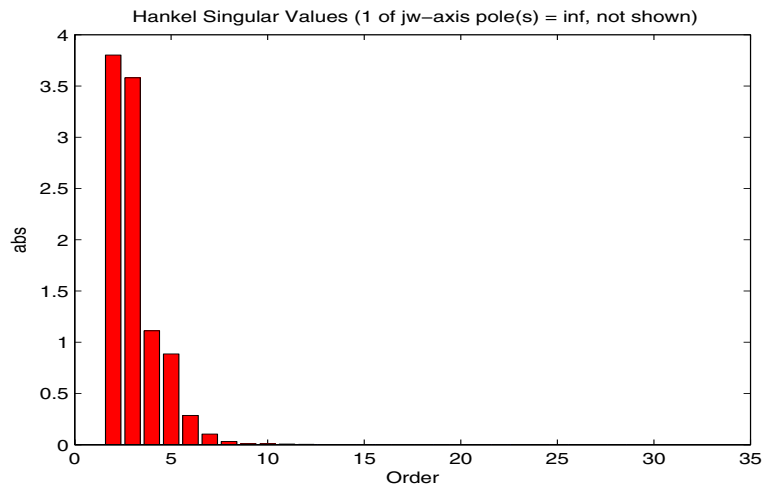

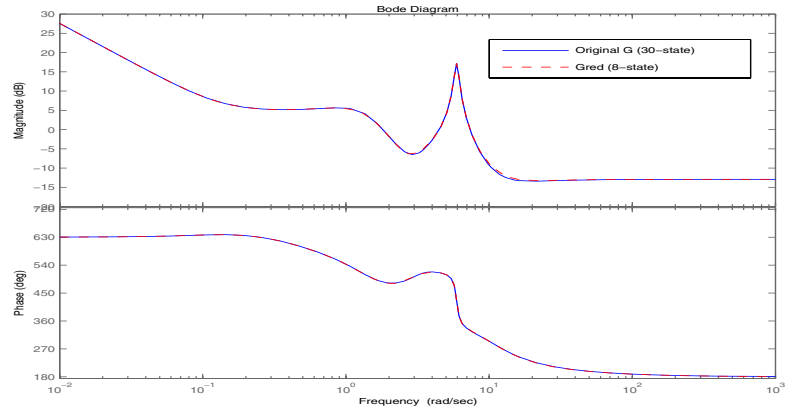

The default algorithm `balancmr` of `reduce` has done a great job of approximating a 30-state model with just 8-state. Again, the rigid body dynamics has been preserved for further controller design.

## Reducing Large Scale Models

For some really large size problems (states  $> 200$ ), `modreal` turns out to be the only way to start the model reduction process. Because of the size and numerical properties associated with those large size, and low damped dynamics, most Hankel based routines can fail to produce a good reduced order model.

`modreal` puts the large size dynamics into the modal form, then truncates the dynamic model to a intermediate stage model with a comfortable size of 50-state or so. From this point on, those more sophisticate Hankel singular value based routines can further reduce this intermediate stage model in a much more accurate fashion to a smaller size for final controller design.

For a typical 240-state flexible spacecraft model in spacecraft industry, applying `modreal` and `bstmr` (or any other additive routines) in sequence can reduce the original 240-state plant dynamics to a 7-state 3-axis model including rigid body dynamics. Any modern robust control design technique mentioned in this toolbox can then be easily applied to this smaller size plant for a controller design.

## Using Normalized Coprime Factor Methods

A special model reduction routine `ncfmr` produces a reduced order model by truncating a balanced coprime set of a given model. It can directly simplify a modern controller with integrators to a smaller size by balanced truncation of the normalized coprime factors. It does not need `modreal` for pre/post processing like the other routines do. However, the integrators will not be preserved afterwards.

```
rand('state',5678); randn('state',1234);
K= rss(30,4,3); % The same model G used in the 1st example
[Kred,info2] = ncfmr(K);
sigma(K,Kred)
```

Again, without specifying the size of the reduced order model, any model reduction routine presented here will plot a Hankel singular value bar chart and prompt for user decision for a reduced model size. In this case, enter “15”.

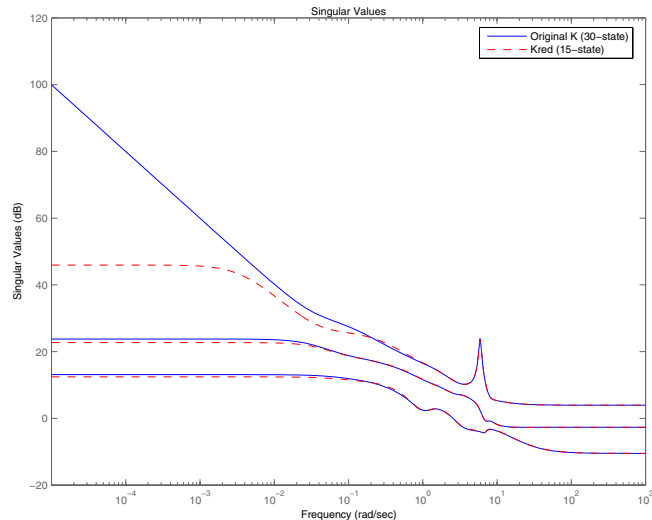

If integral control is important, previously mentioned methods (except `ncfmr`) can nicely preserve the original integrator(s) in the model.

## References

- [15] K. Glover, "All Optimal Hankel Norm Approximation of Linear Multivariable Systems, and Their  $L^\infty$  - error Bounds," *Int. J. Control*, vol. 39, no. 6, pp. 1145-1193, 1984.
- [16] K. Zhou, J. C. Doyle and K. Glover, *Robust and Optimal Control*. Englewood-Cliffs, NJ: Prentice Hall, 1996.
- [17] M. G. Safonov and R. Y. Chiang, "A Schur Method for Balanced Model Reduction," *IEEE Trans. on Automat. Contr.*, vol. 34, no. 7, July 1989, pp. 729-733.
- [18] M. G. Safonov and R. Y. Chiang, and D. J. N. Limebeer, "Optimal Hankel Model Reduction for Nonminimal Systems," *IEEE Trans. on Automat. Contr.*, vol. 35, no. 4, April 1990, pp. 496-502.
- [19] M. G. Safonov and R. Y. Chiang, "Model Reduction for Robust Control: A Schur Relative Error Method," *International J. of Adaptive Control and Signal Processing*, vol. 2, 259-272 (1988).
- [20] G. Obinata and B. D. O. Anderson, *Model Reduction for Control System Design*. London: Springer-Verlag, 2001.



# Robustness Analysis

---

Uncertainty Modeling (p. 4-2)	What is uncertainty modeling? Why is it important?
Robustness Analysis (p. 4-8)	Designing and comparing various controllers
Multi-Input, Multi-Output Robustness Analysis (p. 4-12)	Creating and analyzing uncertain MIMO models
Worst-Case Gain Analysis (p. 4-20)	How to perform worst-case gain analysis
Summary of Robustness Analysis Tools (p. 4-23)	Tables of functions available for robust control

## Uncertainty Modeling

Dealing with, and understanding the effects of uncertainty are important tasks of the control engineer. Reducing the effect of some forms of uncertainty (initial conditions, low frequency disturbances) without catastrophically increasing the effect of other dominant forms (sensor noise, model uncertainty) is the primary job of the feedback control system.

Closed-loop stability is the manner in which we deal with the (always present) uncertainty in initial conditions, or arbitrarily small disturbances.

High-gain feedback in low frequency ranges is a typical manner in which we deal with the effect of unknown biases and disturbances acting on the process output. Roll-off filters in high-frequency ranges is how we are then forced to deal with high-frequency sensor noise in a feedback system.

Finally, notions such as gain and phase margins (and their generalizations) help us quantify the sensitivity of the above ideas (stability and performance) in the face of *model uncertainty*, which is the imprecise knowledge of how the control input directly affects the feedback variables.

The Robust Control Toolbox has built-in features allowing you to specify model uncertainty in a simple and natural manner. The primary building blocks, called *uncertain elements* or *atoms*, are uncertain real parameters and uncertain linear, time-invariant objects. These can be used to create coarse and simple or detailed and complex descriptions of the model uncertainty present within your process models.

Once formulated, high-level system robustness tools can help you analyze the potential degradation of stability and performance of the closed-loop system brought on by the system model uncertainty.

### Creating Uncertain Models of Dynamic Systems

The two dominant forms of model uncertainty are:

- 1 Uncertainty in parameters of the underlying differential equation models, and
- 2 Frequency-domain uncertainty, which often quantifies model uncertainty by describing absolute or relative uncertainty in the process's frequency response.



Using these two basic building blocks, along with conventional system creation commands (such as `ss` and `tf`), you can easily create uncertain system models.

## Creating Uncertain Parameters

An uncertain parameter has a name (used to identify it within an uncertain system with many uncertain parameters) and a nominal value. Being uncertain, it also has variability, described in either one of the following manners

- an additive deviation from the nominal,
- a range about the nominal, or
- a percentage deviation from the nominal.

Create a real parameter, with name 'bw', nominal value 5, and a percentage uncertainty of 10%.

```
bw = ureal('bw',5,'Percentage',10)
```

This creates a `ureal` object. View its properties using the `get` command

```
Uncertain Real Parameter: Name bw, NominalValue 5, variability =
[-10 10]%
get(bw)
      Name: 'bw'
      NominalValue: 5
      Mode: 'Percentage'
      Range: [4.5000 5.5000]
      PlusMinus: [-0.5000 0.5000]
      Percentage: [-10 10]
      AutoSimplify: 'basic'
```

Note that the range of variation (`Range` property) and the additive deviation from nominal (the `PlusMinus` property) are consistent with the `Percentage` property value.

You can create state-space and transfer function models with uncertain real coefficients using `ureal` objects. The result is a *uncertain state-space object*, or `uss`. As an example, use the uncertain real parameter `bw` to model a first order system whose bandwidth is between 4.5 and 5.5 rad/s.

```
H = tf(1,[1/bw 1])
USS: 1 State, 1 Output, 1 Input, Continuous System
```

```
bw: real, nominal = 5, variability = [-10 10]%, 1 occurrence
```

Note that the result `H` is an uncertain system, called a `uss` object. The nominal value of `H` is a state-space object. Verify that the pole is at `-5`.

```
pole(H.NominalValue)
ans =
    -5
```

Next, use `bode` and `step` to examine the behavior of `H`.

```
bode(H, {1e-1 1e2});
```

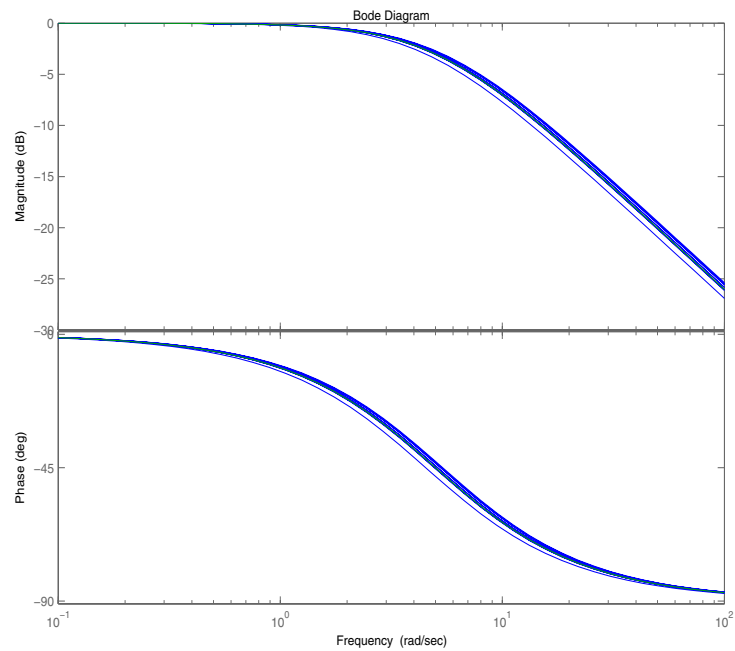

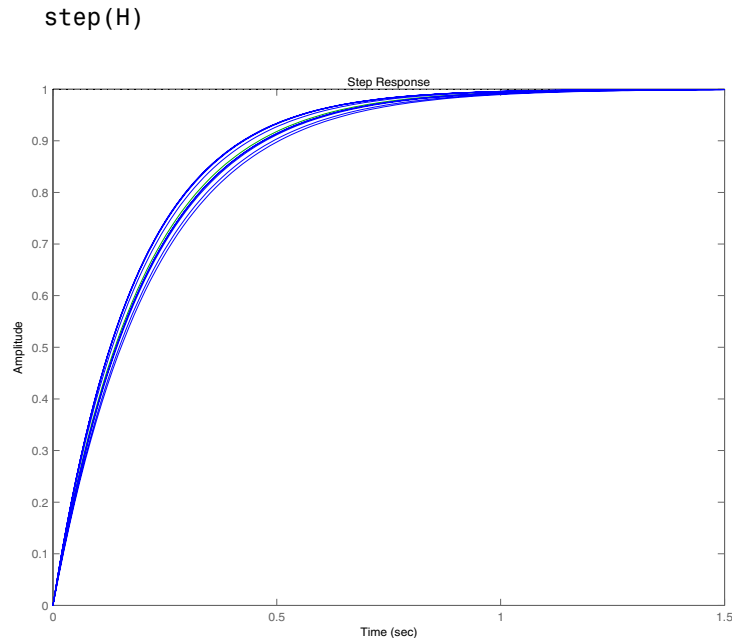

While there are variations in the bandwidth and time constant of  $H$ , the high-frequency rolls off at 20 dB/decade regardless of the value of  $bw$ . You can capture the more complicated uncertain behavior that typically occurs at high frequencies using the `ultidyn` uncertain element which is described next.

## Quantifying Unmodeled Dynamics

An informal manner to describe the difference between the model of a process and the actual process behavior is in terms of bandwidth. It is common to hear “The model is good out to 8 radians/second.” The precise meaning is not clear, but it is reasonable to believe that for frequencies lower than (say) 5 rad/s, the model is accurate, and for frequencies beyond, say 30 rad/s, the model is not necessarily representative of the process behavior. In the frequency range between 5 and 30, the guaranteed accuracy of the model degrades.

The uncertain linear, time-invariant dynamics object, `ultidyn` can be used to model this type of knowledge. A `ultidyn` object represents an unknown linear system whose only known attribute is a uniform magnitude bound on its frequency response. When coupled with a nominal model and a frequency

shaping filter, `ultidyn` objects can be used to capture uncertainty associated with the model dynamics.

Suppose that the behavior of the system modeled by  $H$  significantly deviates from its 1st-order behavior beyond 9 rad/s, for example you believe about 5% potential relative error at low frequency and increasing to 1000% at high frequency where  $H$  rolls off. In order to model frequency domain uncertainty as described above using `ultidyn` objects, follow the steps below.

- 1** Create the nominal system,  $G_{nom}$ , using `tf`, `ss` or `zpk`.  $G_{nom}$  itself may already have parameter uncertainty. In this case  $G_{nom}$  is  $H$ , the first-order system with an uncertain time-constant.
- 2** Create a filter,  $W$ , called the “weight,” whose magnitude represents the relative uncertainty at each frequency. The utility `makeweight` is useful for creating 1st order weights with specific low and high frequency gains, and specified gain crossover frequency.
- 3** Create a `ultidyn` object,  $\Delta$ , with magnitude bound equal to 1.

The uncertain model  $G$  is formed by  $G = G_{nom} * (1 + W * \Delta)$ .

If the magnitude of  $W$  represents an absolute (rather than relative) uncertainty, use the formula  $G = G_{nom} + W * \Delta$  instead.

The command below carry out the steps described above.

```
Gnom = H;
W = makeweight(.05,9,10);
Delta = ultidyn('Delta',[1 1]);
G = Gnom*(1+W*Delta)
USS: 2 States, 1 Output, 1 Input, Continuous System
Delta: 1x1 LTI, max. gain = 1, 1 occurrence
bw: real, nominal = 5, variability = [-10 10]%, 1 occurrence
```

Note that the result  $G$  is also an uncertain system, with dependence on both  $\Delta$  and  $bw$ . You can use `bode` to make a Bode plot of 20 random samples of  $G$ 's behavior, over the frequency range [0.1 100] rad/s.

```
bode(G, {1e-1 1e2}, 25)
```

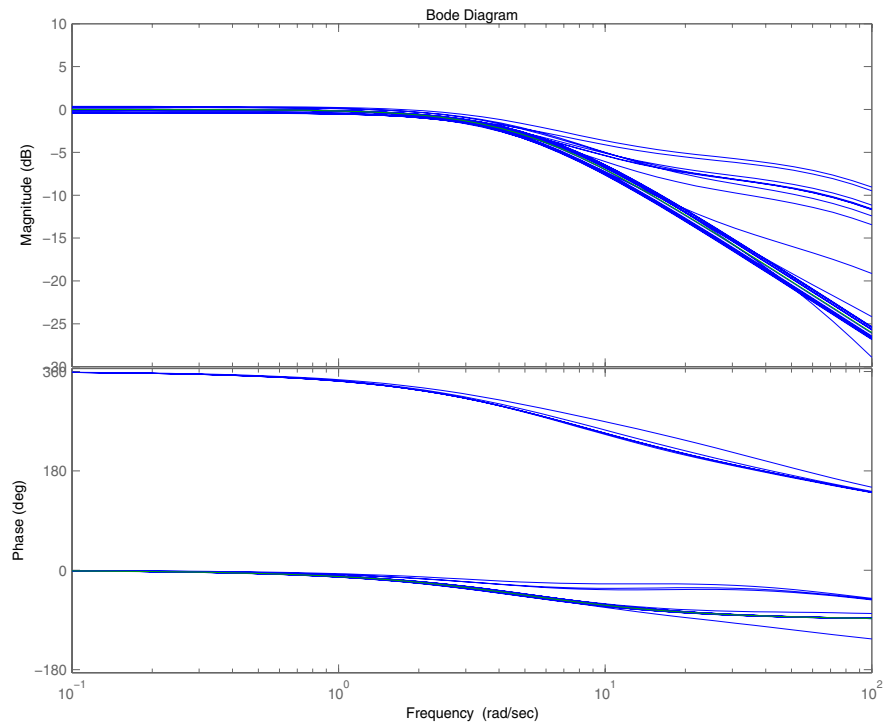

In the next section, we design and compare two feedback controllers for  $G$ .

## Robustness Analysis

Next, we design a feedback controller for  $G$ . The goals of this design are the usual ones -- good steady-state tracking and disturbance rejection properties. Since the plant model is nominally a first-order lag, we chose a PI control architecture. Given desired closed-loop damping ratio,  $\xi$  and natural frequency  $\omega_n$ , the design equations for  $K_I$  and  $K_P$  are (based on the nominal open-loop time constant of 0.2.)

$$K_I = \frac{\omega_n^2}{5}, \quad K_P = \frac{2\xi\omega_n}{5} - 1$$

In order to study how the uncertain behavior of  $G$  impacts the achievable closed-loop bandwidth, design two controllers, both achieving  $\xi=0.707$ , with different  $\omega_n$ , 3 and 7.5 respectively.

```
xi = 0.707;  
wn = 3;  
K1 = tf([(2*xi*wn/5-1) wn*wn/5],[1 0]);  
wn = 7.5;  
K2 = tf([(2*xi*wn/5-1) wn*wn/5],[1 0]);
```

Note that the nominal closed-loop bandwidth achieved by  $K_2$  is in a region where  $G$  has significant model uncertainty. It will not be surprising if the model variations lead to significant degradations in the closed-loop performance.

Form the closed-loop systems using feedback.

```
T1 = feedback(G*K1,1);  
T2 = feedback(G*K2,1);
```

Plot the step responses of 20 samples of each closed-loop system.

```
tfinal = 3;
```

```
step(T1,'b',T2,'r',tfinal,20)
```

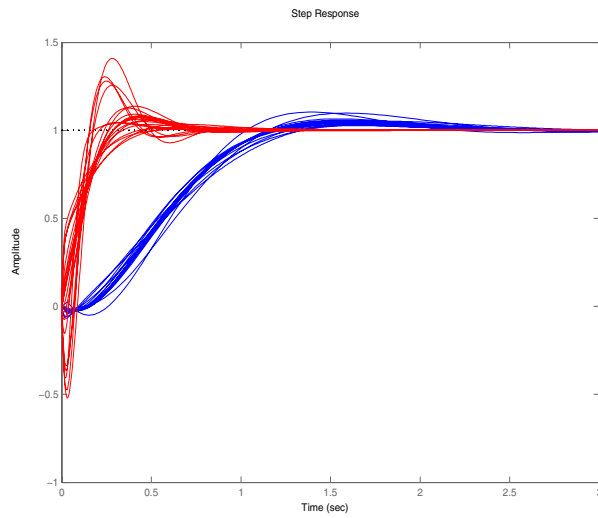

The step responses for T2 exhibit a faster rise time since K2 sets a higher closed loop bandwidth. However, the model variations have a greater effect.

You can use `robuststab` to check the robustness of stability to the model variations.

```
[stabmarg1,destabu1,report1] = robuststab(T1);
stabmarg1
stabmarg1 =
    ubound: 4.0241
    lbound: 4.0241
    destabfreq: 3.4959
[stabmarg2,destabu2,report2] = robuststab(T2);
stabmarg2
stabmarg2 =
    ubound: 1.2545
    lbound: 1.2544
    destabfreq: 10.5249
```

The `stabmarg` variable gives lower and upper bounds on the stability margin. A stability margin greater than 1 means the system is stable for all values of the modeled uncertainty. A stability margin less than 1 means there are allowable values of the uncertain elements that make the system unstable. The `report` variable briefly summarizes the analysis.

```
report1
report1 =
Uncertain System is robustly stable to modeled uncertainty.
-- It can tolerate up to 402% of modeled uncertainty.
-- A destabilizing combination of 402% the modeled uncertainty
exists, causing an instability at 3.5 rad/s.
report2
report2 =
Uncertain System is robustly stable to modeled uncertainty.
-- It can tolerate up to 125% of modeled uncertainty.
-- A destabilizing combination of 125% the modeled uncertainty
exists, causing an instability at 10.5 rad/s.
```

While both systems are stable for all variations, their performance is clearly affected to different degrees. To determine how the uncertainty affects closed-loop performance, you can use `wcgain`, you can compute the *worst-case* effect of the uncertainty on the peak magnitude of the closed-loop sensitivity ( $S=1/(1+GK)$ ) function. This peak gain is typically correlated with the amount of overshoot in a step response.

To do this, form the closed-loop sensitivity functions, and call `wcgain`.

```
S1 = feedback(1,G*K1);
S2 = feedback(1,G*K2);
[maxgain1,wcu1] = wcgain(S1);
maxgain1
maxgain1 =
    lbound: 1.8684
    ubound: 1.9025
    critfreq: 3.5152
[maxgain2,wcu2] = wcgain(S2);
maxgain2
maxgain2 =
    lbound: 4.6031
    ubound: 4.6671
    critfreq: 11.0231
```



The `maxgain` variable gives lower and upper bounds on the worst-case peak-gain of the Sensitivity transfer function, as well as the specific frequency where the maximum gain occurs. The `wcu` variable contains specific values of the uncertain elements that achieve this worst-case behavior.

You can use `usubs` to substitute these worst-case values for uncertain elements, and compare the nominal and worst-case behavior. Use `bodemag` and `step` to make the comparison.

```
bodemag(S1.NominalValue,'b',usubs(S1,wcu1),'b');
hold on
bodemag(S2.NominalValue,'r',usubs(S2,wcu2),'r');
hold off
```

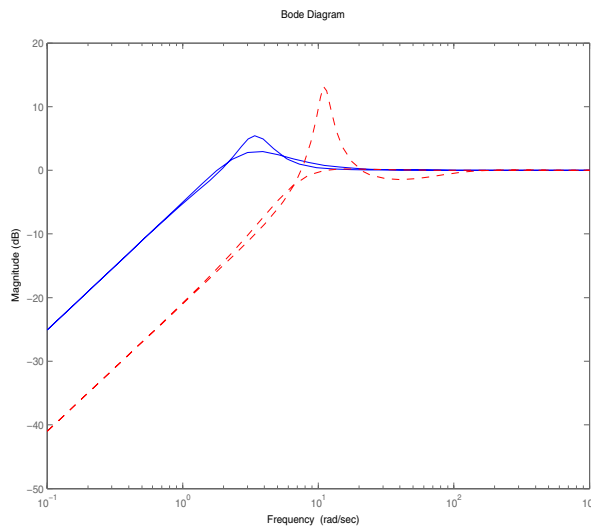

Clearly, while K2 achieves better nominal sensitivity than K1, the nominal closed-loop bandwidth extends too far into the frequency range where the process uncertainty is very large. Hence the worst-case performance of K2 is inferior to K1 for this particular uncertain model.

In the next section, we explore these robustness analysis tools further on a multi-input, multi-output system.

## Multi-Input, Multi-Output Robustness Analysis

So far, we've focused on simple uncertainty models of single-input and single-output systems, predominantly from a transfer function perspective. You can also create uncertain state-space models made up of uncertain state-space matrices. Moreover, all of the analysis tools covered thus far can be applied to these systems as well.

Consider, for example, a 2-input, 2-output, 2-state system whose model has parametric uncertainty in the state-space matrices. First create an uncertain parameter `p`. Using the parameter, make uncertain `A` and `C` matrices. The `B` matrix happens to be not-uncertain, although you will add frequency domain input uncertainty to the model in the next section.

```
p = ureal('p',10,'Percentage',10);
A = [0 p;-p 0];
B = eye(2);
C = [1 p;-p 1];
H = ss(A,B,C,[0 0;0 0]);
```

You can view the properties of the uncertain system `H` using the `get` command.

```
get(H)
      a: [2x2 umat]
      b: [2x2 double]
      c: [2x2 umat]
      d: [2x2 double]
StateName: {2x1 cell}
      Ts: 0
InputName: {2x1 cell}
OutputName: {2x1 cell}
InputGroup: [1x1 struct]
OutputGroup: [1x1 struct]
NominalValue: [2x2 ss]
Uncertainty: [1x1 atomlist]
      Notes: {}
      UserData: []
```

The properties `a`, `b`, `c`, `d`, and `StateName` behave in exactly the same manner as `ss` objects. The properties `InputName`, `OutputName`, `InputGroup` and `OutputGroup` behave in exactly the same manner as all of the system objects (`ss`, `zpk`, `tf`, and `frd`). The `NominalValue` is a `ss` object.

## Adding Independent Input Uncertainty to Each Channel

The model for  $H$  did not include actuator dynamics. Said differently, the actuator models are unity-gain for all frequencies.

Nevertheless it is known that the behavior of the actuator for channel 1 is both modestly uncertain (say 10%) at low frequencies and the high frequency behavior beyond 20 rad/s is not accurately modeled. Similar statements hold for actuator in channel 2, with larger modest uncertainty at low frequency (say 20%) but accuracy out to 45 rad/s.

Use `ultidyn` objects `Delta1` and `Delta2`, along with shaping filters `W1` and `W2` to add this form of frequency domain uncertainty into the model.

```
W1 = makeweight(.1,20,50);
W2 = makeweight(.2,45,50);
Delta1 = ultidyn('Delta1',[1 1]);
Delta2 = ultidyn('Delta2',[1 1]);
G = H*blkdiag(1+W1*Delta1,1+W2*Delta2)
USS: 4 States, 2 Outputs, 2 Inputs, Continuous System
  Delta1: 1x1 LTI, max. gain = 1, 1 occurrence
  Delta2: 1x1 LTI, max. gain = 1, 1 occurrence
      p: real, nominal = 10, variability = [-10 10]%, 2
occurrences
```

Note that  $G$  is a 2-input, 2-output uncertain system, with dependence on 3 uncertain elements, `Delta1`, `Delta2` and `p`. It has 4 states, 2 from  $H$ , and one each from the shaping filters `W1` and `W2` which are embedded in  $G$ .

You can plot a 2-second step response of several samples of  $G$ . The 10% uncertainty in the natural frequency is obvious.

step(G,2)

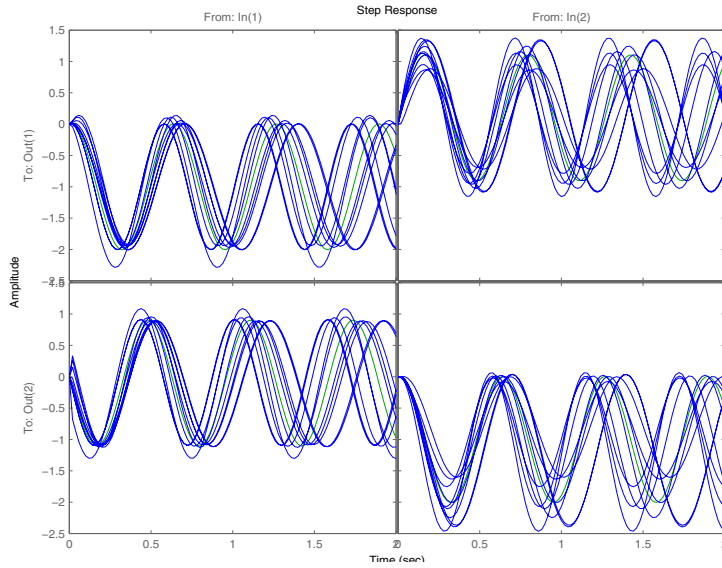

You can plot Bode plot of 50 samples of  $G$ . The high-frequency uncertainty in the model is also obvious. For clarity, start the Bode plot beyond the resonance.

```
bode(G, {13 100}, 50)
```

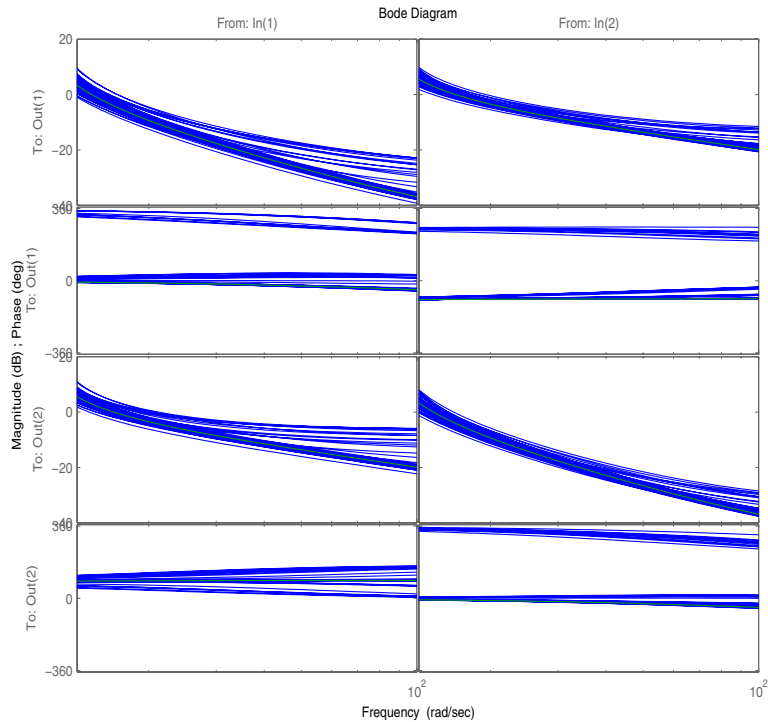

## Closed-Loop Robustness Analysis

You need to load the controller and verify that it is 2-input and 2-output.

```
load mimoKexample
size(K)
State-space model with 2 outputs, 2 inputs, and 9 states.
```

You can use the command `loopsens` to form all of the standard plant/controller feedback configurations, including sensitivity and complementary sensitivity at both the input and output. Since  $G$  is uncertain, all of the closed-loop systems will be uncertain as well.

```
F = loopsens(G,K)
F =
    Poles: [13x1 double]
```

```

Stable: 1
  Si: [2x2 uss]
  Ti: [2x2 uss]
  Li: [2x2 uss]
  So: [2x2 uss]
  To: [2x2 uss]
  Lo: [2x2 uss]
  PSi: [2x2 uss]
  CSo: [2x2 uss]

```

F is a structure with many fields. The poles of the nominal closed-loop system are in F.poles, and F.Stable is 1 if the nominal closed-loop system is stable. In the remaining 10 fields, S stands for sensitivity, T for complementary sensitivity, and L for open-loop gain. The suffix i and o refer to the input and output of the plant (G). Finally P and C refer to the “plant” and “controller.”

Hence Ti is mathematically the same as

$$K(I + GK)^{-1}G$$

while Lo is  $G*K$ , and CSo is mathematically the same as

$$K(I + GK)^{-1}$$

You can examine the transmission of disturbances at the plant input to the plant output using bodemag on F.PSi. Graph 50 samples along with the nominal.

```
bodemag(F.PSi, ':-', {1e-1 100}, 50)
```

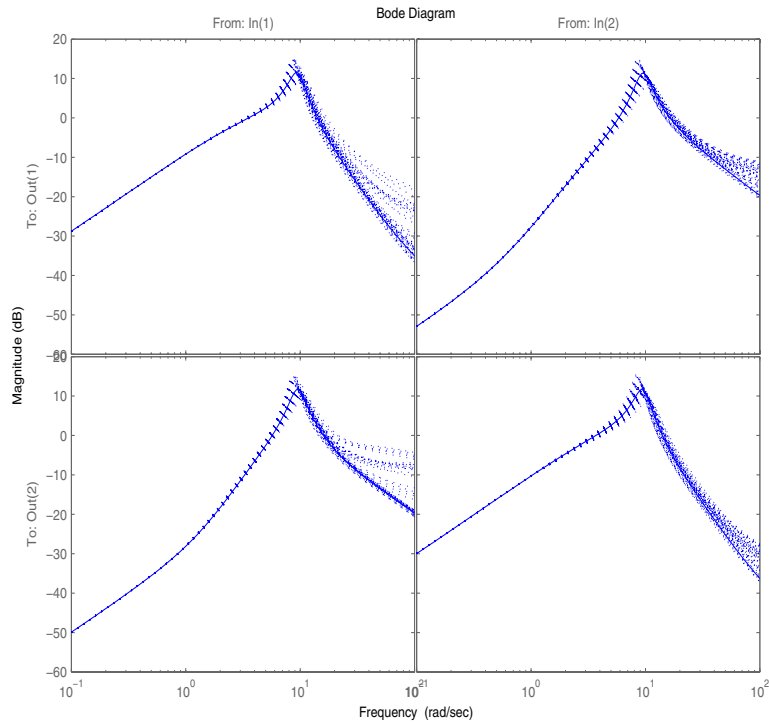

## Nominal Stability Margins

You can use `loopmargin` to investigate loop-at-a-time gain and phase margins, loop-at-a-time disk margins and simultaneous multivariable margins. They are computed for the nominal system and do not reflect the uncertainty models within  $G$ .

Explore the simultaneous margins individually at the plant input, individually at the plant output, and simultaneously at both input and output.

```
[I,DI,SimI,O,DO,SimO,Sim] = loopmargin(G,K);
```

The third output argument are the **simultaneous** gain and phase variations allowed in all input channels to the plant.

SimI

```
SimI =  
  GainMargin: [0.1180 8.4769]  
  PhaseMargin: [-76.5441 76.5441]  
  Frequency: 6.2287
```

This information implies that the gain at the plant input can vary in both channels independently by factors between (approximately) 1/8 and 8, **as well** as phase variations up to 76 degrees.

The 6th output argument are the simultaneous gain and phase variations allowed in all output channels to the plant.

```
SimO  
SimO =  
  GainMargin: [0.1193 8.3836]  
  PhaseMargin: [-76.3957 76.3957]  
  Frequency: 18.3522
```

Note that the simultaneous margins at the plant output are similar to those at the input. This is not always the case in multiloop feedback systems.

The last output argument are the simultaneous gain and phase variations allowed in all input **and** output channels to the plant. As expected, when you consider all such variations simultaneously, the margins are somewhat smaller than those at the input or output alone.

```
Sim  
Sim =  
  GainMargin: [0.5671 1.7635]  
  PhaseMargin: [-30.8882 30.8882]  
  Frequency: 18.3522
```

Nevertheless, these numbers indicate a generally robust closed-loop system, able to tolerate significant gain (more than +/-50% in each channel) and phase 30 degrees variations simultaneously in all input and output channels of the plant.

## Robustness of Stability Model Uncertainty

With `loopmargin`, you determined various margins of the nominal, multiloop system. These margins are computed only for the nominal system, and do not reflect the uncertainty explicitly modeled by the `ureal` and `ultidyn` objects. When working with detailed, complex uncertain system models, the



conventional margins computed by `loopmargin` may not always be indicative of the actual stability margins associated with the uncertain elements. You can use `robuststab` to check the stability margin of the system to these specific modeled variations.

In this example, use `robuststab` to compute the stability margin of the closed-loop system represented by `Delta1`, `Delta2` and `p`.

Use any of the closed-loop systems within `F = loopsens(G,K)`. All of them, `F.Si`, `F.To`, etc., have the same internal dynamics, and hence the stability properties are the same.

```
[stabmarg,desgtabu,report] = robuststab(F.So);
stabmarg
stabmarg =
    ubound: 2.2175
    lbound: 2.2175
    destabfreq: 13.7576
report
report =
Uncertain System is robustly stable to modeled uncertainty.
-- It can tolerate up to 222% of modeled uncertainty.
-- A destabilizing combination of 222% the modeled uncertainty
exists, causing an instability at 13.8 rad/s.
```

This analysis confirms what the `loopmargin` analysis suggested. The closed-loop system is quite robust, **in terms of stability**, to the variations modeled by the uncertain parameters `Delta1`, `Delta2` and `p`. In fact, the system can tolerate more than twice the modeled uncertainty without losing closed-loop stability.

In the next section, we study the effect of these variations on the closed-loop output sensitivity function.

## Worst-Case Gain Analysis

You can plot the Bode magnitude of the nominal output sensitivity function. It clearly shows decent disturbance rejection in all channels at low frequency.

```
bodemag(F.So.NominalValue, {1e-1 100})
```

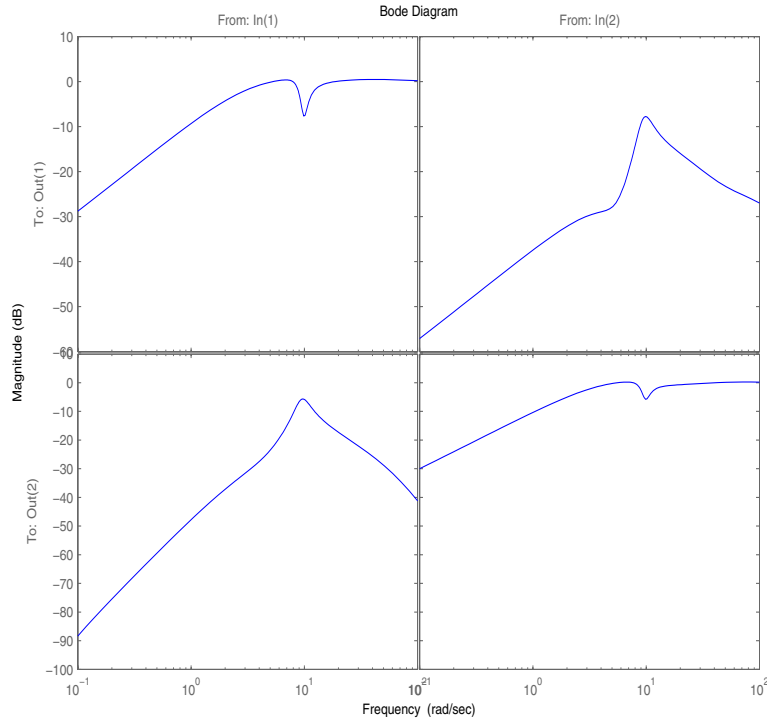

You can compute the peak value of the maximum singular value of the frequency response matrix using `norm`.

```
[PeakNom, freq] = norm(F.So.NominalValue, 'inf')
PeakNom =
    1.1317
freq =
    7.0483
```

The peak is about 1.13, occurring at a frequency of 36 rad/s.

What is the maximum output sensitivity gain that is achieved, when the uncertain elements  $\Delta_1$ ,  $\Delta_2$  and  $p$  vary over their ranges? You can use `wcgain` to answer this.

```
[maxgain,wcu] = wcgain(F.So);
maxgain
maxgain =
    lbound: 2.1017
    ubound: 2.1835
    critfreq: 8.5546
```

The analysis indicates that the worst-case gain is somewhere between 2.1 and 2.2. The frequency where the peak is achieved is about 8.5.

You can substitute the values for  $\Delta_1$ ,  $\Delta_2$  and  $p$  that achieve the gain of 2.1 using `usubs`. Make the substitution in the output complementary sensitivity, and do a step response.

```
step(F.To.NominalValue,usubs(F.To,wcu),5)
```

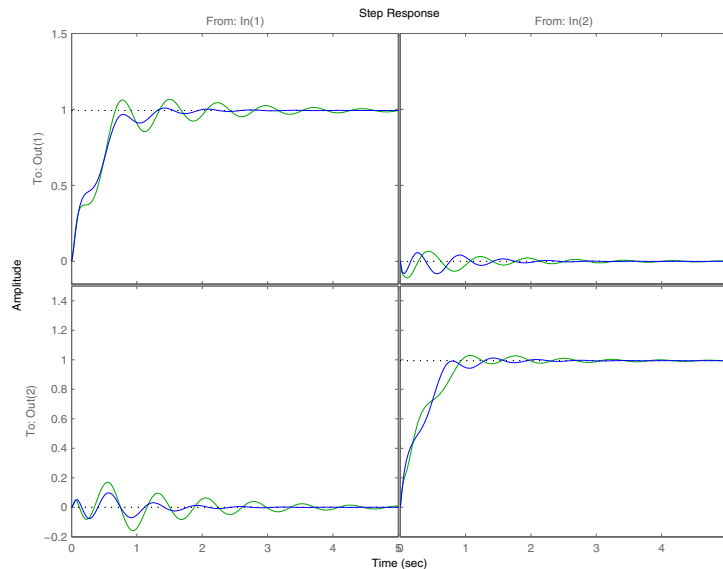

The perturbed response, which is the worst combination of uncertain values in terms of output sensitivity amplification does not show significant degradation of the command response significantly. The settling time is increased by about

50%, from 2 to 4, and the off-diagonal coupling is increased by about a factor of about 2, but is still quite small.

## Summary of Robustness Analysis Tools

<b>Function</b>	<b>Description</b>
ureal	Creates uncertain real parameter
ultidyn	Creates uncertain, linear, time-invariant dynamics
uss	Creates uncertain state-space object from uncertain state-space matrices
ufrd	Creates uncertain frequency response object
loopsens	Compute all relevant open and closed-loop quantities for a MIMO feedback connection
loopmargin	Compute loop-at-a-time, as well as MIMO gain and phase margins for a multiloop system, including the simultaneous gain/phase margins
robustperf	Robustness performance of uncertain systems
robuststab	Computes the robust stability margin of a nominally stable uncertain system
wcgain	Computes the worst-case gain of a nominally stable uncertain system
wcmargin	Computes worst-case (over uncertainty) loop-at-a-time disk-based gain and phase margins
wcsens	Computes worst-case (over uncertainty) sensitivity of plant-controller feedback loop



# H-Infinity and Mu Synthesis

---

This chapter covers an introduction to  $H_\infty$  and structured singular value,  $\mu$ , control design.

H-Infinity Performance (p. 5-2)	Discusses a modern approach to characterizing closed-loop performance
Application of $H_\infty$ and $\mu$ to Active Suspension Control (p. 5-10)	A fully worked example of designing a compensator for active suspension control
Functions for Control Design (p. 5-24)	A discussion of the functions you can use for robust control design
Appendix: Interpretation of H-Infinity norm (p. 5-26)	Details about norms and their properties
References (p. 5-33)	A list of relevant papers and books about H-infinity and structured singular value design

## H-Infinity Performance

### Performance as Generalized Disturbance Rejection

The modern approach to characterizing closed-loop performance objectives is to measure the size of certain closed-loop transfer function matrices using various matrix norms. Matrix norms provide a measure of how large output signals can get for certain classes of input signals. Optimizing these types of performance objectives, over the set of stabilizing controllers is the main thrust of recent optimal control theory, such as  $L_1$ ,  $H_2$ , and  $H_\infty$ , and optimal control. Hence, it is important to develop a clear understanding of how many types of control objectives can be posed as a minimization of closed-loop transfer functions.

Consider a tracking problem, with disturbance rejection, measurement noise, and control input signal limitations, as shown in Figure 5-1.  $K$  is some controller to be designed and  $G$  is the system we want to control.

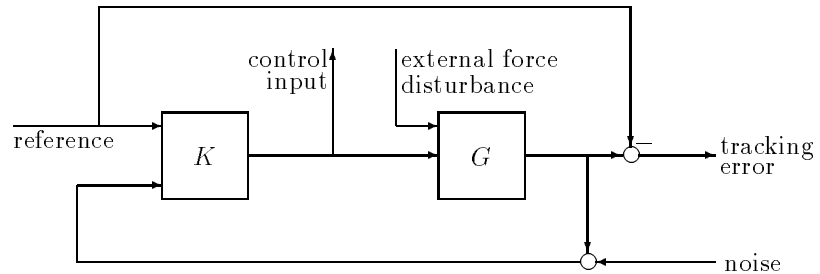

#### Typical Closed-Loop Performance Objective

A reasonable, though not precise, design objective would be to Design  $K$  to keep tracking errors *and* control input signal *small* for all reasonable reference commands, sensor noises, *and* external force disturbances.

Hence, a natural performance objective is the closed-loop *gain* from exogenous influences (reference commands, sensor noise, and external force disturbances) to regulated variables (tracking errors and control input signal). Specifically,



let  $T$  denote the closed-loop mapping from the outside influences to the regulated variables,

$$\underbrace{\begin{bmatrix} \text{tracking error} \\ \text{control input} \end{bmatrix}}_{\text{regulated variables}} = T \underbrace{\begin{bmatrix} \text{reference} \\ \text{external force} \\ \text{noise} \end{bmatrix}}_{\text{outside influences}}$$

We can assess performance by measuring the gain from *outside influences* to *regulated variables*. In other words, good performance is associated with  $T$  being small. Since the closed-loop system is a multi-input, multi-output (MIMO) dynamic system, there are two different aspects to the gain of  $T$ :

- Spatial (*vector* disturbances and *vector* errors)
- Temporal (dynamical relationship between input/output signals)

Hence the performance criterion must account for:

- Relative magnitude of outside influences
- Frequency dependence of signals
- Relative importance of the magnitudes of regulated variables

So, if the performance objective is in the form of a matrix norm, it should actually be a *weighted norm*

$$\|W_L T W_R\|$$

where the weighting function matrices  $W_L$  and  $W_R$  are frequency dependent, to account for bandwidth constraints and spectral content of exogenous signals. A natural (mathematical) manner to characterize acceptable performance is in terms of the MIMO  $\|\cdot\|_\infty$  ( $H_\infty$ ) norm. See the Appendix at the end of this chapter for an interpretation of the  $H_\infty$  norm and signals.

### Interconnection with Typical MIMO Performance Objectives

The closed-loop performance objectives is formulated as weighted closed-loop transfer functions which are to be made small through feedback. A generic example, which includes many relevant terms, is shown in block diagram form in Figure 5-1. In the diagram,  $G$  denotes the plant model and  $K$  is the feedback controller.

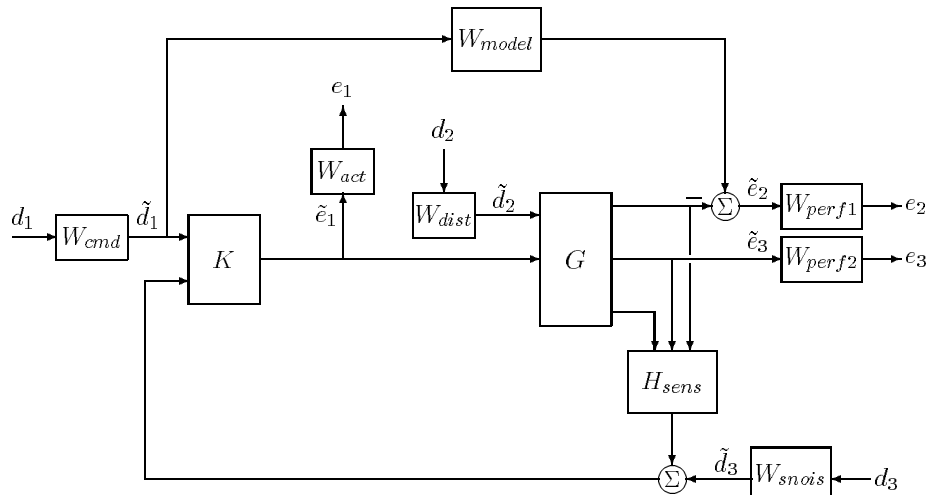

**Figure 5-1: Generalized and Weighted Performance Block Diagram**

The blocks in Figure 5-1 might be scalar (SISO) and/or multivariable (MIMO), depending on the specific example. The mathematical objective of  $H_\infty$  control is to make the closed-loop MIMO transfer function  $T_{ed}$  satisfy  $\|T_{ed}\|_\infty < 1$ . The weighting functions are used to scale the input/output transfer functions such that when  $\|T_{ed}\|_\infty < 1$ , the relationship between  $\tilde{d}$  and  $\tilde{e}$  is suitable.

Performance requirements on the closed-loop system are transformed into the  $H_\infty$  framework with the help of *weighting* or *scaling* functions. Weights are selected to account the relative magnitude of signals, their frequency dependence and their relative importance. This is captured in Figure 5-1 where the weights or scalings,  $[W_{cmd}, W_{dist}, W_{snois}]$ , are used to transform and scale the normalized input signals  $[d_1, d_2, d_3]$  into physical units defined as  $[d_1, d_2, d_3]$ . Similarly weights or scalings  $[W_{act}, W_{perf1}, W_{perf2}]$  transform and scale

physical units into normalized output signals,  $[e_1, e_2, e_3]$ . An interpretation of the signals, weighting functions and models follows.

Signal	Meaning
$d_1$	Normalized reference command
$\tilde{d}_1$	Typical reference command in physical units
$d_2$	Normalized exogenous disturbances
$\tilde{d}_2$	Typical exogenous disturbances in physical units
$d_3$	Normalized sensor noise
$\tilde{d}_3$	Typical sensor noise in physical units
$e_1$	Weighted control signals
$\tilde{e}_1$	Actual control signals in physical units
$e_2$	Weighted tracking errors
$\tilde{e}_2$	Actual tracking errors in physical units
$e_3$	Weighted plant errors
$\tilde{e}_3$	Actual plant errors in physical units

### $W_{cmd}$

$W_{cmd}$  is included in  $H_\infty$  control problems that require tracking of a reference command.  $W_{cmd}$  shapes (magnitude and frequency) the normalized reference command signals into the actual (or typical) reference signals that you expect to occur. It describes the magnitude and the frequency dependence of the reference commands generated by the normalized reference signal. Normally  $W_{cmd}$  is flat at low frequency and rolls off at high frequency. For example, in a flight control problem, fighter pilots can (and will) generate stick input reference commands up to a bandwidth of about 2Hz. Suppose that the stick has a maximum travel of three inches. Pilot commands could be modeled as normalized signals passed through a first order filter

$$W_{act} = \frac{3}{\frac{1}{2 \cdot 2\pi}s + 1}$$

### **$W_{model}$**

$W_{model}$  represents a desired ideal model for the closed-loop system and is often included in problem formulations with tracking requirements. Inclusion of an ideal model for tracking is often called a *model matching* problem, i.e. the objective of the closed-loop system is to match the defined model. For good command tracking response, you might desire the closed-loop system to respond like a well-damped second-order system. The ideal model would then be

$$W_{model} = 10 \frac{\omega^2}{s^2 + 2\zeta\omega s + \omega^2}$$

for specific desired natural frequency  $\omega$  and desired damping ratio  $\zeta$ . Unit conversions might be necessary to insure exact correlation between the ideal model and the closed-loop system. In the fighter pilot example, suppose that roll-rate is being commanded and  $10^\circ/\text{second}$  response is desired for each inch of stick motion. Then, in these units, the appropriate model is

$$W_{model} = 10 \frac{\omega^2}{s^2 + 2\zeta\omega s + \omega^2}$$

### **$W_{dist}$**

$W_{dist}$  shapes the frequency content and magnitude of the exogenous disturbances affecting the plant. For example, consider an electron microscope as the plant. The dominant performance objective is to mechanically isolate the microscope from outside mechanical disturbances, such as the ground excitations, sound (pressure) waves, and air currents. You would capture the spectrum and relative magnitudes of these disturbances with the transfer function weighting matrix  $W_{dist}$ .

**$W_{perf1}$** 

$W_{perf1}$  weights the difference between the response of the closed-loop system and the ideal model,  $W_{model}$ . Often you may desire accurate matching of the ideal model at low frequency and require less accurate matching at higher frequency, in which case  $W_{perf1}$  is flat at low frequency, rolls off at first or second order, and flattens out at a small, nonzero value at high frequency. The inverse of the weight is related to the allowable size of tracking errors, in the face of the reference commands and disturbances described by  $W_{ref}$  and  $W_{dist}$ .

 **$W_{perf2}$** 

$W_{perf2}$  penalizes variables internal to the process  $G$ , such as actuator states that are internal to  $G$ , or other variables that are not part of the tracking objective.

 **$W_{act}$** 

$W_{act}$  is used to shape the penalty on control signal use.  $W_{act}$  is a frequency varying weighting function used to penalize limits on the deflection/position, deflection rate/velocity, etc., response of the control signals, in the face of the tracking and disturbance rejection objectives defined above. Each control signal is usually penalized independently.

 **$W_{snois}$** 

$W_{snois}$  represents frequency domain models of sensor noise. Each sensor measurement feedback to the controller has some noise, which is often higher in one frequency range than another. The  $W_{snois}$  weight tries to capture this information, derived from laboratory experiments or based on manufacturer measurements, in the control problem. For example, medium grade accelerometers have substantial noise at low frequency and high frequency. Therefore the corresponding  $W_{snois}$  weight would be larger at low and high frequency and have a smaller magnitude in the mid-frequency range. Displacement or rotation measurement is often quite accurate at low frequency and in steady-state, but responds poorly as frequency increases. The weighting function for this sensor would be small at low frequency, gradually increase in magnitude as a first or second system, and level out at high frequency.

 **$H_{sens}$** 

$H_{sens}$  represents a model of the sensor dynamics or an external anti-aliasing filter. The transfer functions used to describe  $H_{sens}$  are based on physical

characteristics of the individual components. These models might also be lumped into the plant model  $G$ .

This generic block diagram has tremendous flexibility and many control performance objectives can be formulated in the  $H_\infty$  framework using this block diagram description.

### Robustness in the $H_\infty$ Framework

Performance and robustness tradeoffs in control design were discussed in the context of multivariable loop shaping in Chapter \*\*\*. In the  $H_\infty$  control design framework, you can include robustness objectives as additional disturbance to error transfer functions to be kept small. Consider the following figure of a closed-loop feedback system with additive and multiplicative uncertainty models.

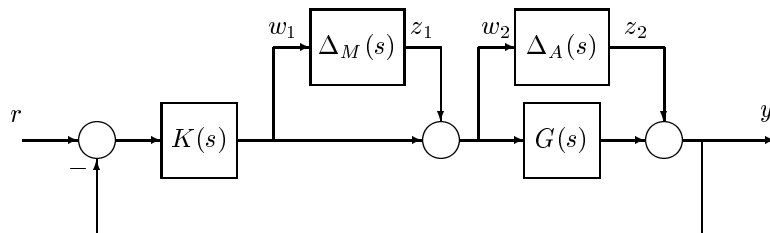

The transfer function matrices are defined as:

$$TF(s)_{z_1 \rightarrow w_1} = T_I(s) = KG(I)^{-1},$$

$$TF(s)_{z_2 \rightarrow w_2} = KS_O(s) = K(I + GK)^{-1}$$

where  $T_I(s)$  denotes the input complementary sensitivity function and  $S_O(s)$  denotes the output sensitivity function. Theorems 1 and 2 in Chapter \*\*\* give bounds on the size of the transfer function matrices from  $z_1$  to  $w_1$  and  $z_2$  to  $w_2$  to insure the closed-loop system is robust to multiplicative uncertainty,  $\Delta_M(s)$ , at the plant input and additive uncertainty,  $\Delta_A(s)$ , around the plant  $G(s)$ . In the  $H_\infty$  control problem formulation, the robustness objectives enter the synthesis procedure as additional input/output signals to be kept small. The interconnection with the uncertainty blocks removed follows.

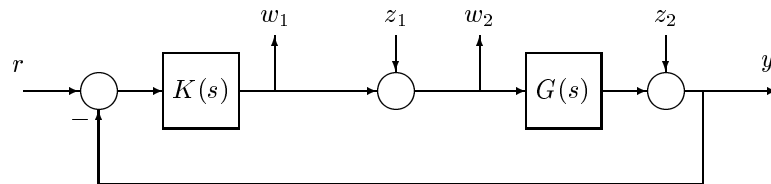

The  $H_\infty$  control robustness objective is now in the same format as the performance objectives. That is minimize the  $H_\infty$  norm of the transfer matrix from  $z$ ,  $[z_1, z_2]$ , to  $w$ ,  $[w_1, w_2]$ .

Weighting or scaling matrices are often introduced to shape the frequency and magnitude content of the sensitivity and complementary sensitivity transfer function matrices. Let  $W_M$  correspond to the multiplicative uncertainty and  $W_A$  correspond to the additive uncertainty model.  $\Delta_M(s)$  and  $\Delta_A(s)$  are assumed to be norm bounded by 1, i.e.  $|\Delta_M(s)| < 1$  and  $|\Delta_A(s)| < 1$ . Hence as a function of frequency,  $|W_M(j\omega)|$  and  $|W_A(j\omega)|$  are the respective sizes of the largest anticipated additive and multiplicative plant perturbations.

The multiplicative weighting or scaling,  $W_M$ , represents a percentage error in the model and is often small in magnitude at low frequency, between 0.05 and 0.20 (5% to 20% modeling error) growing larger in magnitude at high frequency, 2 to 5 ((200% to 500% modeling error). The weight will transition by crossing a magnitude value of 1, which corresponds to 100% uncertainty in the model, at least twice the bandwidth of the closed-loop system. A typical

multiplicative weight is

$$W_M = 0.10 \frac{\frac{1}{5}s + 1}{\frac{1}{200}s + 1} .$$

The additive weight or scaling,  $W_A$ , represents an absolute error which is often small at low frequency and large in magnitude at high frequency. The magnitude of this weight depends directly on the magnitude of the plant model,  $G(s)$ . You can initially select  $W_A$  to be a constant whose magnitude is 10% of the  $\|G(s)\|_\infty$ .

## Application of $H_\infty$ and $\mu$ to Active Suspension Control

Conventional passive suspensions employ a spring and damper between the car body and wheel assembly, represent a trade-off between conflicting performance metrics such as passenger comfort, road holding, and suspension deflection. Active suspensions allow the designer to balance these objectives using a hydraulic actuator, controlled by feedback, between the chassis and wheel assembly.

In this section, you will design of an active suspension system for a quarter car body and wheel assembly model using the  $H_\infty$  control design technique. You will see the trade-off between passenger comfort, i.e. minimizing car body travel, versus suspension travel as the performance objective.

### Quarter Car Suspension Model

The quarter car model shown will be used to design active suspension control laws.

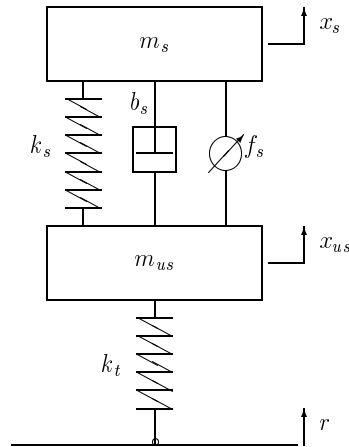

The sprung mass,  $m_s$ , represents the car chassis, while the unsprung mass,  $m_{us}$ , represents the wheel assembly. The spring,  $k_s$ , and damper,  $b_s$ , represent a passive spring and shock absorber that are placed between the car body and the wheel assembly, while the spring,  $k_t$ , serves to model the compressibility of the pneumatic tyre. The variables  $x_s$ ,  $x_{us}$ , and  $r$  are the car body travel, the wheel travel, and the road disturbance respectively. The force  $f_s$ , kN, applied between the sprung and unsprung masses, is controlled by feedback and



represents the active component of the suspension system. The dynamics of the actuator, and assume that the control signal is the force  $f_s$  are ignored in this example. Defining  $x_1 := x_s$ ,  $x_2 := \dot{x}_s$ ,  $x_3 := x_{us}$  and  $x_4 := \dot{x}_{us}$ , the following state-space description of the quarter car dynamics.

$$\begin{aligned}\dot{x}_1 &= x_2, \\ \dot{x}_2 &= -\frac{1}{m_s}[k_s(x_1 - x_3) + b_s(x_2 - x_4) - f_s], \\ \dot{x}_3 &= x_4, \\ \dot{x}_4 &= \frac{1}{m_{us}}[k_s(x_1 - x_3) + b_s(x_2 - x_4) - k_t(x_3 - r) - f_s].\end{aligned}$$

The following component values are taken from reference [Lin97].

$$\begin{aligned}m_s &= 290; & \% \text{ kg} \\ m_{us} &= 59; & \% \text{ kg} \\ b_s &= 1000; & \% \text{ N/m/s} \\ k_s &= 16182; & \% \text{ N/m} \\ k_t &= 190000; & \% \text{ N/m}\end{aligned}$$

A linear, time-invariant model of the quarter car model, `qcar`, is constructed from the equations of motion and parameter values. The inputs to the model, `qcar`, are the road disturbance and actuator force respectively and the outputs are the car body deflection, acceleration and suspension deflection.

$$\begin{aligned}A12 &= [0 \ 1 \ 0 \ 0; [-k_s \ -b_s \ k_s \ b_s]/m_s]; \\ A34 &= [0 \ 0 \ 0 \ 1; [k_s \ b_s \ -k_s - k_t \ -b_s]/m_{us}]; \\ B12 &= [0 \ 0; 0 \ 10000/m_s]; \\ B34 &= [0 \ 0; [k_t \ -10000]/m_{us}]; \\ C &= [1 \ 0 \ 0 \ 0; A12(2, :); 1 \ 0 \ -1 \ 0; 0 \ 0 \ 0 \ 0]; \\ D &= [0 \ 0; B12(2, :); 0 \ 0; 0 \ 1]; \\ \text{qcar} &= \text{ss}([A12; A34], [B12; B34], C, D);\end{aligned}$$

It is well known [Hedrick90] that the acceleration transfer function has an invariant point at the *tyrehop frequency*, 56.7 rad/sec. Similarly, the suspension deflection transfer function has an invariant point at the *rattlespace frequency*, 23.3 rad/sec. The trade-off between passenger comfort and suspension deflection is due to the fact that it is not possible to

simultaneously keep both the above transfer functions small around the tyrehop frequency and in the low frequency range.

### Linear $H_\infty$ Controller Design

The design of linear suspension controllers that emphasize either passenger comfort or suspension deflection. The controllers in this section are designed using linear  $H_\infty$  synthesis [FialBal]. As is standard in the  $H_\infty$  framework, the performance objectives are achieved via minimizing weighted transfer function norms.

Weighting functions serve two purposes in the  $H_\infty$  framework: they allow the direct comparison of different performance objectives with the same norm and they allow for frequency information to be incorporated into the analysis. For more details on  $H_\infty$  control design the reader is referred to [DGKF, Fran1, GloD, SkoP, Zame] and the references therein. A block diagram of the  $H_\infty$  control design interconnection for the active suspension problem is shown in the following figure.

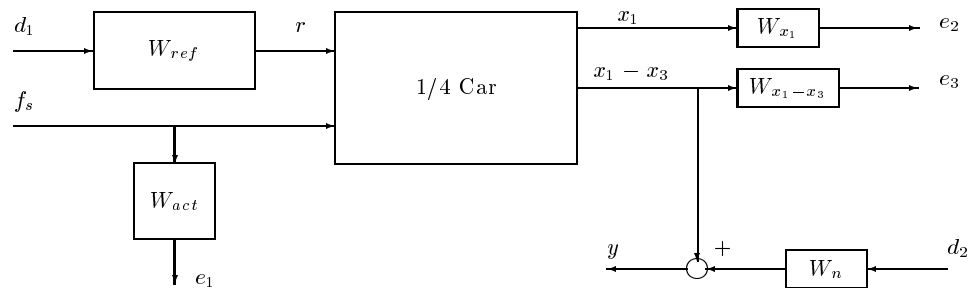

The measured output or feedback signal,  $y$ , is the suspension deflection  $x_1 - x_3$ . The controller acts on this signal to produce the control input, the hydraulic actuator force  $f_s$ . The block  $W_n$  serves to model sensor noise in the measurement channel.  $W_n$  is set to a sensor noise value of 0.01 m.

$$W_n = 0.01;$$

In a more realistic design,  $W_n$  would be frequency dependent and would serve to model the noise associated with the displacement sensor. The weight  $W_{ref}$  is used to scale the magnitude of the road disturbances. We assume that the maximum road disturbance is 7 cm and hence choose  $W_{ref} = 0.07$ .

```
Wref = 0.07;
```

The magnitude and frequency content of the control force  $f_s$  is limited by the weighting function  $W_{act}$ . We choose  $W_{act} = \frac{100}{13s+50}$ . The magnitude of the weight increases above 50 rad/s in order to limit the closed-loop bandwidth.

```
Wact = (100/13)*tf([1 50],[1 500]);
```

## $H_\infty$ Control Design 1

The purpose of the weighting functions  $W_{x_1}$  and  $W_{x_1-x_3}$  are to keep the car deflection and the suspension deflection small over the desired frequency ranges. In the first design, you are designing the controller for passenger comfort and hence the car body deflection  $x_1$  is penalized.

```
Wx1 = 8*tf(2*pi*5,[1 2*pi*5]);
```

The weight magnitude rolls off above  $5 \times 2\pi$  rad/s to respect a well-known  $H_\infty$  design rule-of-thumb that requires the performance weights to roll off before an open-loop zero (56.7 rad/s in this case). The suspension deflection weight,  $W_{x_1-x_3}$ , is not included in this control problem formulation

You can construct the weighted  $H_\infty$  plant model for control design, denoted `qcaric1`, is using the `sysic` command. The control signal corresponds to the last input to `qcaric1`,  $f_s$ . The car body acceleration, which is noisy, is the measured signal and corresponds to the last output of `qcaric1`.

```
systemnames = 'qcar Wn Wref Wact Wx1';
inputvar = '[ d1; d2; fs ]';
outputvar = '[ Wact; Wx1; qcar(2)+Wn ]';
input_to_qcar = '[ Wref; fs]';
input_to_Wn = '[ d2 ]';
input_to_Wref = '[ d1 ]';
input_to_Wact = '[ fs ]';
input_to_Wx1 = '[ qcar(1) ]';
qcaric1 = sysic;
```

A  $H_\infty$  controller is synthesized with the `hinfsyn` command. There is one control input, `ncont`, the hydraulic actuator force and one measurement signal, `nmeas`, the car body acceleration.

```
ncont = 1;
nmeas = 1;
```

```
[K1,Sc11,gam1] = hinfsyn(qcaric1,nmeas,ncont);
CL1 = lft(qcar([1:4 2],1:2),K1);
sprintf('H-infinity controller K1 achieved a norm of %2.5g',gam1)
ans =
H-infinity controller K1 achieved a norm of 0.56698
```

You can analyze the  $H_\infty$  controller by constructing the closed-loop feedback system, CL1. Bode magnitude plots of the passive suspension and active suspension are shown in the following figure.

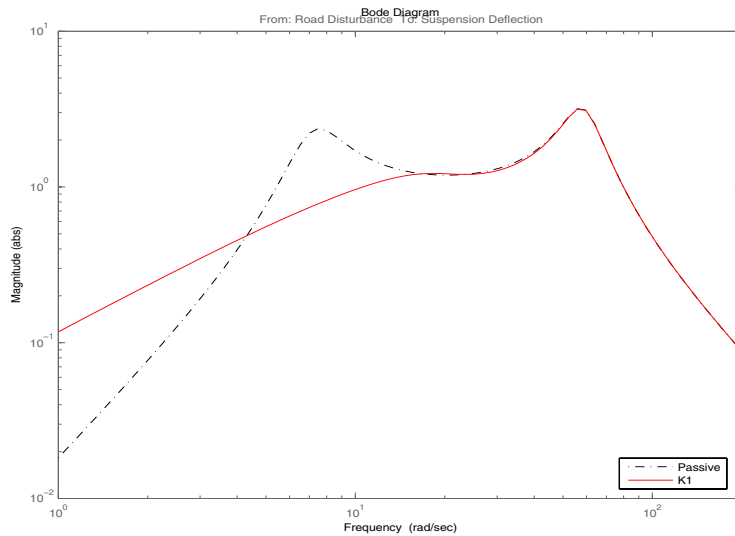

## $H_\infty$ Control Design 2

In the second design, you are designing the controller to keep the suspension deflection transfer function small. Hence the road disturbance to suspension deflection  $x_1-x_3$  is penalized via the weighting function  $W_{x1 \times 3}$ . The  $W_{x1 \times 3}$  weight magnitude rolls off above 10 rad/s to roll off before an open-loop zero (23.3 rad/s) in the design.

$$W_{x1 \times 3} = 25 * tf(1, [1/10 \ 1]);$$

The car deflection weight,  $W_{x_1}$ , is not included in this control problem formulation. You can construct the weighted  $H_\infty$  plant model for control design,

denoted `qcaric2`, is using the `sysic` command. The same control and measurements are used as in the first design.

```
M = iconnect;
d = icsignal(2);
fs = icsignal(1);
ycar = icsignal(size(qcar,1));
M.Equation{1} = equate(ycar,qcar*[Wref*d(1); fs]);
M.Input = [d;fs];
M.Output = [Wact*fs;Wx1*ycar(1);ycar(2)+Wn*d(2)];
qcaric2 = M.System;
```

The second  $H_\infty$  controller is synthesized with the `hinfsyn` command.

```
[K2,Sc12,gam2] = hinfsyn(qcaric2,nmeas,ncont);
CL2 = lft(qcar([1:4 2]),1:2),K2);
sprintf('H-infinity controller K2 achieved a norm of %2.5g',gam2)
ans =
H-infinity controller K2 achieved a norm of 0.89949
```

Recall that this  $H_\infty$  control design emphasizes minimization of suspension deflection over passenger comfort where as the first  $H_\infty$  design focussed on passenger comfort.

You can analyze the  $H_\infty$  controller by constructing the closed-loop feedback system, `CL2`. Bode magnitude plots of the transfer function from road

disturbance to suspension deflection for both controllers and the passive suspension system shown in the following figure.

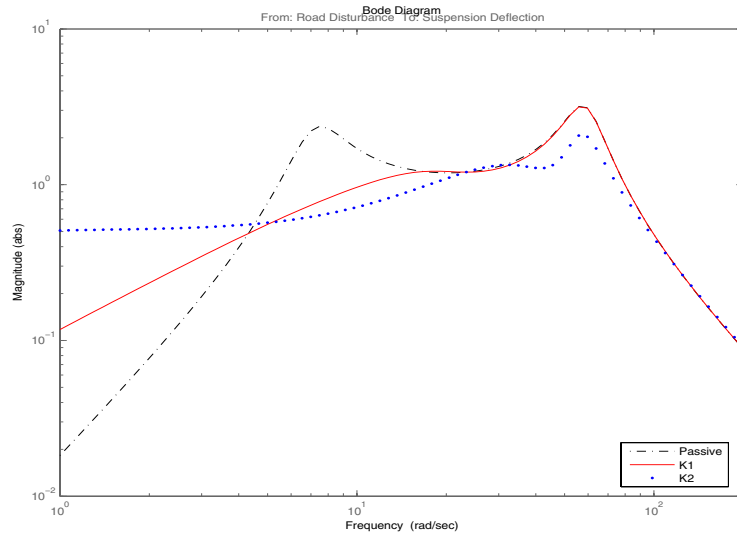

The dotted and solid lines in the figure are the closed-loop frequency responses that result from the different performance weighting functions selected. Observe the reduction in suspension deflection in the vicinity of the tyrehop frequency  $\omega_1= 56.7$  rad/s, and the corresponding increase in the acceleration frequency response in this vicinity. Also, compared to Design 1, a reduction in suspension deflection has been achieved for frequencies below the rattlespace frequency  $\omega_2= 23.3$  rad/sec.

The second  $H_\infty$  control design attenuates both resonance modes where as the first controller focussed its efforts on the first mode, the rattlespace frequency at 23.3 rad/sec.

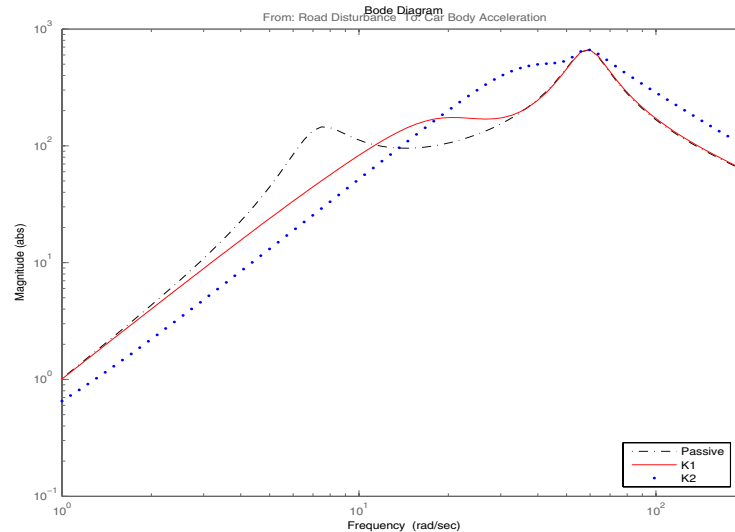

All the analysis till now has been in the frequency domain. Time domain performance characteristics are critical to the success of the active suspension system on the car. Time response plots of the two  $H_\infty$  controllers are shown in following figures. The dashed, solid and dotted lines correspond to the passive suspension,  $H_\infty$  controller 1 and 2 respectively. All responses correspond to the road disturbance  $r(t)$

$$r(t) = a(1 - \cos 8\pi t),$$

$$= 0 \text{ otherwise,}$$

where  $a=0.025$  corresponds to a road bump of peak magnitude 5 cm. Observe that the acceleration response of Design 1 to the 5 cm bump is very good however the suspension deflection is larger than for Design 2. This is due to the fact that suspension deflection was not penalized in this design. The suspension deflection response of Design 2 to a 5 cm bump is good however the acceleration response to the 5 cm bump is much inferior to Design 1 (see the

figure). Once again this is due to the fact that car body displacement and acceleration were not penalized in design 2.

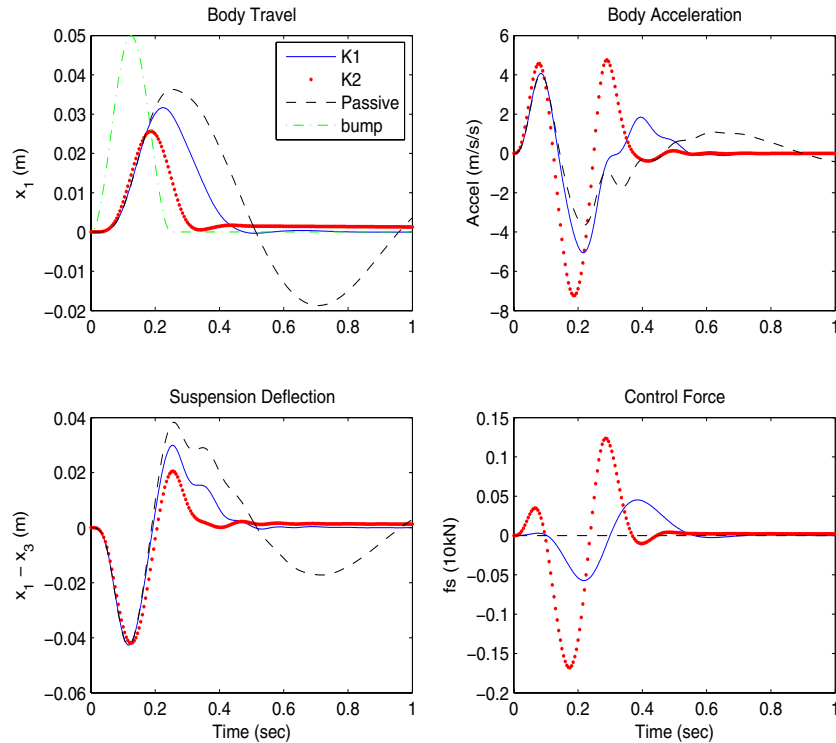

Designs 1 and 2 represent extreme ends of the performance trade-off spectrum. This section described synthesis of  $H_\infty$  to achieve the performance objectives on the active suspension system. Equally, if not more important, is the design of controls robust to model error or uncertainty.

The goal of every control design is to achieve the desired performance specifications on the nominal model as well as other plants that are *close* to the nominal model. In other words, it you want to achieve the performance objectives in the presence of model error or uncertainty. This is called *robust performance*. In the next section, you will design a controller which achieves robust performance using the  $\mu$ -synthesis control design methodology. The



active suspension system again serves as the example. Instead of an assume perfect actuator, a nominal actuator model with modeling error is introduced into the control problem.

## Control Design via $\mu$ -Synthesis

The active suspension  $H_\infty$  controllers designed in the previous section ignored the hydraulic actuator dynamics. In section, you will include a first order model of the hydraulic actuator dynamics as well as an uncertainty model to account for differences between the actuator model and the actual actuator dynamics.

The hydraulic actuator is modeled as  $act = \frac{1}{\frac{1}{60}s + 1}$ .

```
act = tf(1,[1/60 1]);
```

The actuator model itself is uncertain. You can describe the actuator model error as a set of possible models using a weighting function. At low frequency, below 4 rad/s, it can vary up to 10% from its nominal value. Around 4 rad/s the percentage variation starts to increase and reaches 400% at approximately 800 rad/s. The model uncertainty is represented by the weight,  $W_{unc}$ , which corresponds to the frequency variation of the model uncertainty and the uncertain LTI dynamic object  $\Delta_{unc}$  defined as unc.

```
Wunc = 0.10*tf([1/4 1],[1/800 1]);
unc = ultidyn('unc',[1 1]);
actmod = act*(1+ Wunc*unc)
USS: 2 States, 1 Output, 1 Input, Continuous System
unc: 1x1 LTI, max. gain = 1, 1 occurrence
```

The actuator model, actmod, is an uncertain state-space system. The following Bode plot shows the nominal actuator model, denoted with a '+' symbol, and 50 random actuator models described by actmod.

```
bode(actmod,'b/r+',50,logspace(-1,3,120))
```

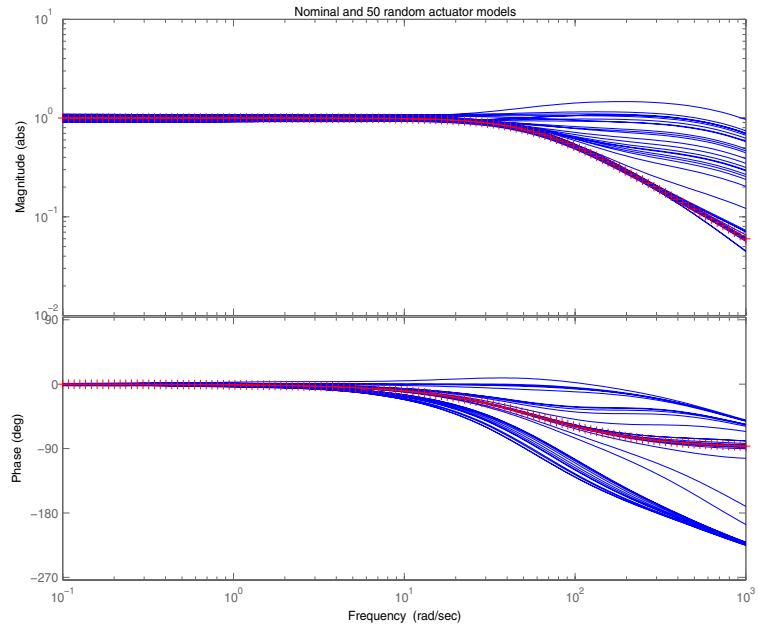

The uncertain actuator model,  $actmod$ , represents the model of the hydraulic actuator used for control. The revised control design interconnection diagram is

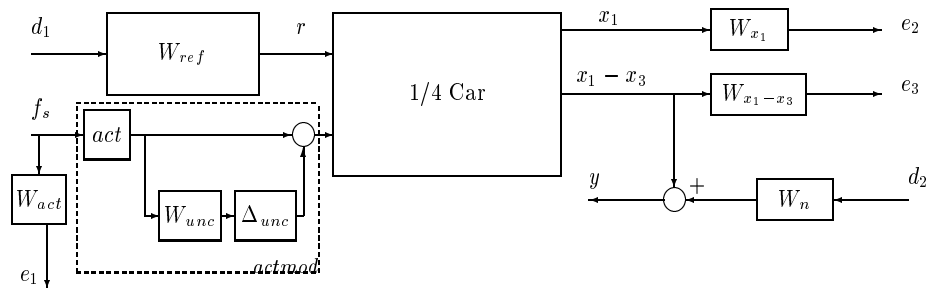

You are designing the controller for passenger comfort, as in the first  $H_\infty$  control design, hence the car body deflection  $x_1$  is penalized with  $W_{x1}$ . The uncertain weighted  $H_\infty$  plant model for control design, denoted `qcaricunc`, is using the `sysic` command. As previously described, the control signal corresponds to the last input to `qcaric1`, `fs`. The car body acceleration, which is noisy, is the measured signal and corresponds to the last output of `qcaricunc`.

```
systemnames = 'qcar Wn Wref Wact Wx1 actmod';
inputvar = '[ d1; d2; fs ]';
outputvar = '[ Wact; Wx1; qcar(2)+Wn ]';
input_to_actmod = '[ fs ]';
input_to_qcar = '[ Wref; fs]';
input_to_Wn = '[ d2 ]';
input_to_Wref = '[ d1 ]';
input_to_Wact = '[ fs ]';
input_to_Wx1 = '[ qcar(1) ]';
qcaricunc = sysic;
```

A  $\mu$ -synthesis controller is synthesized using  $D$ - $K$  iteration with the `dksyn` command. The  $D$ - $K$  iteration procedure is an approximation to  $\mu$ -synthesis that attempts to synthesize a controller that achieves robust performance [SteD, BalPac, PacDB, SkoP]. There is one control input, `ncont`, the hydraulic actuator force and one measurement signal, `nmeas`, the car body acceleration.

```
[Kdk,CLdk,gdk] = dksyn(qcaricunc,nmeas,ncont);
CLdkunc = lft(qcar([1:4 2]),1:2)*blkdiag(1,actmod),Kdk);
sprintf('mu-synthesis controller Kdk achieved a norm of
%2.5g',gdk)
ans =
mu-synthesis controller Kdk achieved a norm of 0.53946
```

You can analyze the  $\mu$ -synthesis controller by constructing the closed-loop feedback system, `CLdkunc`. Bode magnitude plots of the passive suspension and active suspension systems on the nominal actuator model with  $H_\infty$  design 1 and the  $\mu$ -synthesis controller are shown in the following figure. Note that the

$\mu$ -synthesis controller better attenuates the first resonant mode at the expense of decrease performance below 3 rad/sec.

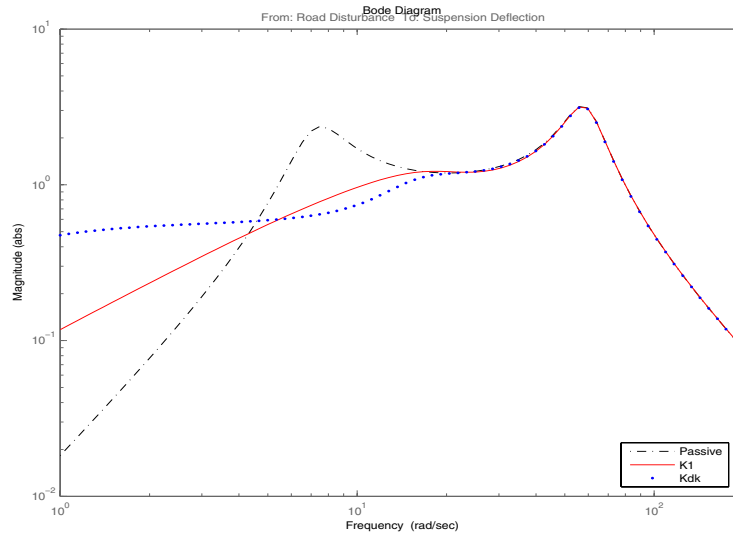

It is important to understand how robust both controllers are in the presence of model error. You can simulate the active suspension system with the  $H_\infty$  design 1 and the  $\mu$ -synthesis controller. The uncertain closed-loop systems, CL1unc and CLdkunc, are formed with K1 and Kdk respectively. For each uncertain system, 40 random plant models in the model set are simulated. As you can see, both controllers are robust and perform well in the presence of actuator model error. The  $\mu$ -synthesis controller, Kdk, achieves slightly better performance than  $H_\infty$  design 1.

```
CL1unc = lft(qcar([1:4 2],1:2)*blkdiag(1,actmod),K1);
[CLdkunc40,dksamples] = usample(CLdkunc,40);
CL1unc40 = usubs(CL1unc,dksamples);
```

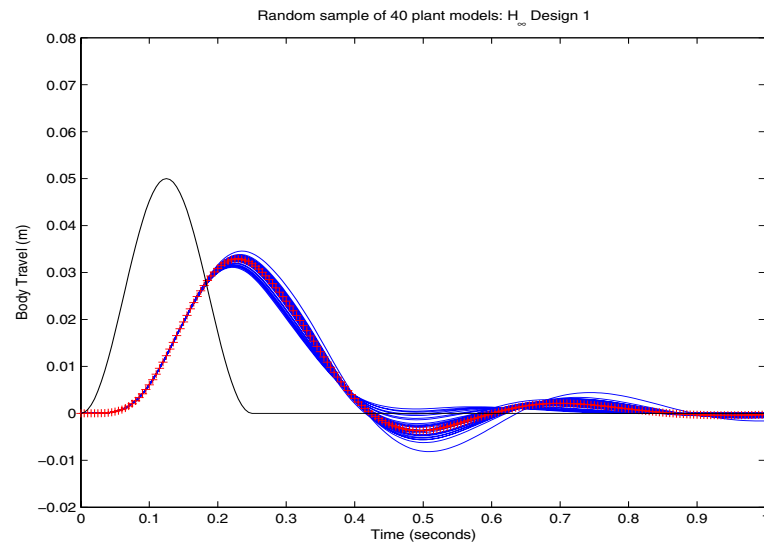
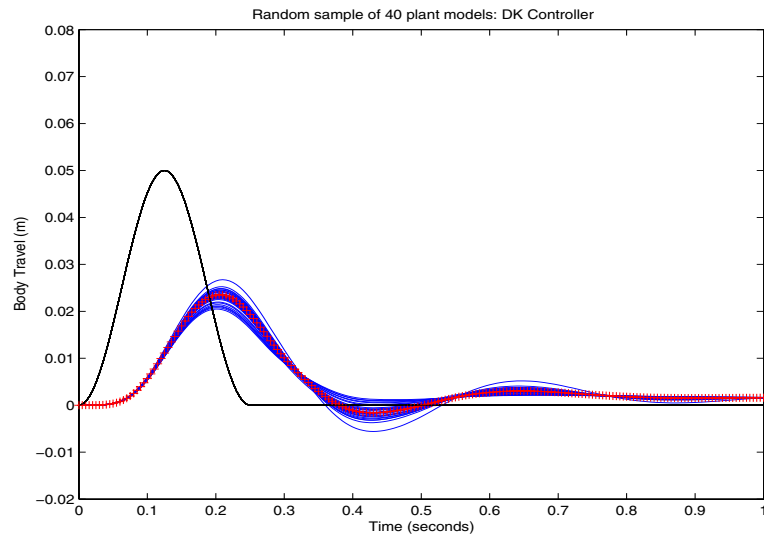

## Functions for Control Design

The term control system design refers to the process of synthesizing a feedback control law that meets design specifications in a closed-loop control system. The design methods are iterative, combining parameter selection with analysis, simulation and insight into the dynamics of the plant. The Robust Control Toolbox provides a set of commands that you can use for a broad range of multivariable control applications, including:

- $H_2$  control design
- $H_\infty$  standard and loop shaping control design
- $H_\infty$  normalized coprime factor control design
- Mixed  $H_2/H_\infty$  control design
- $\mu$ -synthesis via  $D$ - $K$  iteration
- Sample-data  $H_\infty$  control design

These functions cover both continuous and discrete-time problems. The following table summarizes the  $H_2$  and  $H_\infty$  control design commands.

Function	Description
augw	Augments plant weights for mixed-sensitivity control design
h2hinfyn	Mixed $H_2/H_\infty$ controller synthesis
h2syn	$H_2$ controller synthesis
hinfyn	$H_\infty$ controller synthesis.
loopsyn	$H_\infty$ loop shaping controller synthesis
ltrsyn	Loop-transfer recovery controller synthesis
mixsyn	$H_\infty$ mixed-sensitivity controller synthesis
ncfsyn	$H_\infty$ normalized coprime factor controller synthesis
sdhinfyn	Sample-data $H_\infty$ controller synthesis

The following table summarizes the  $\mu$ -synthesis via  $D$ - $K$  iteration control design commands.

<b>Function</b>	<b>Description</b>
<code>dksyn</code>	Synthesis of a robust controller via $\mu$ -synthesis
<code>dkitopt</code>	Create a <code>dksyn</code> options object
<code>drawmag</code>	Interactive mouse-based sketching and fitting tool
<code>fitfrd</code>	Fit scaling frequency response data with LTI model
<code>fitmagfrd</code>	Fit scaling magnitude data with stable, minimum-phase model

## Appendix: Interpretation of H-Infinity norm

### Norms of Signals and Systems

There are several ways of defining norms of a scalar signal  $e(t)$  in the time domain. We will often use the 2-norm, ( $L_2$ -norm), for mathematical convenience, which is defined as

$$\|e\|_2 := \left( \int_{-\infty}^{\infty} e(t)^2 dt \right)^{\frac{1}{2}}$$

If this integral is finite, then the signal  $e$  is *square integrable*, denoted as  $e \in L_2$ . For vector-valued signals,

$$e(t) = \begin{bmatrix} e_1(t) \\ e_2(t) \\ \vdots \\ e_n(t) \end{bmatrix}$$

the 2-norm is defined as

$$\begin{aligned} \|e\|_2 &:= \left( \int_{-\infty}^{\infty} \|e(t)\|_2^2 dt \right)^{\frac{1}{2}} \\ &= \left( \int_{-\infty}^{\infty} e^T(t)e(t) dt \right)^{\frac{1}{2}} \end{aligned}$$

In  $\mu$ -Tools the dynamic systems we deal with are exclusively linear, with state-space model



$$\begin{bmatrix} \dot{x} \\ e \end{bmatrix} = \begin{bmatrix} A & B \\ C & D \end{bmatrix} \begin{bmatrix} x \\ d \end{bmatrix}$$

or, in the transfer function form

$$e(s) = T(s)d(s), \quad T(s) := C(sI - A)^{-1}B + D$$

Two mathematically convenient measures of the transfer matrix  $T(s)$  in the frequency domain are the matrix  $H_2$  and  $H_\infty$  norms,

$$\|T\|_2 := \left[ \frac{1}{2\pi} \int_{-\infty}^{\infty} \|T(j\omega)\|_F^2 d\omega \right]^{\frac{1}{2}} \quad \|T\|_\infty := \max_{w \in \mathbf{R}} \bar{\sigma}[T(j\omega)]$$

where the Frobenius norm (see the MATLAB norm command) of a complex matrix  $M$  is

$$\|M\|_F := \sqrt{\text{trace}(M^*M)}$$

Both of these transfer function norms have input/output time-domain interpretations. If, starting from initial condition  $x(0) = 0$ , two signals  $d$  and  $e$  are related by

$$\begin{bmatrix} \dot{x} \\ e \end{bmatrix} = \begin{bmatrix} A & B \\ C & D \end{bmatrix} \begin{bmatrix} x \\ d \end{bmatrix}$$

then:

- for  $d$ , a unit intensity, white noise process, the steady-state variance of  $e$  is  $\|T\|_2$ .
- The  $L_2$  (or RMS) gain from  $d \rightarrow e$ ,

$$\max_{d \neq 0} \frac{\|e\|_2}{\|d\|_2}$$

is equal to  $\|T\|_\infty$ . This is discussed in greater detail in the next section.

## Using Weighted Norms to Characterize Performance

In any performance criterion, we must also account for:

- Relative magnitude of outside influences
- Frequency dependence of signals
- Relative importance of the magnitudes of regulated variables

So, if the performance objective is in the form of a matrix norm, it should actually be a *weighted norm*

$$\|W_L T W_R\|$$

where the weighting function matrices  $W_L$  and  $W_R$  are frequency dependent, to account for bandwidth constraints and spectral content of exogenous signals. Within the structured singular value setting considered in chapter \*\*\*\*, the most natural (mathematical) manner to characterize acceptable performance is in terms of the MIMO  $\|\cdot\|_\infty$  ( $H_\infty$ ) norm. For this reason, we discuss some interpretations of the  $H_\infty$  norm.

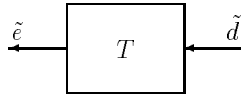

**Figure 5-2: Unweighted MIMO System**

Suppose  $T$  is a MIMO stable linear system, with transfer function matrix  $T(s)$ . For a given driving signal  $\tilde{d}(t)$ , define  $\tilde{e}$  as the output, as shown in Figure 5-3.

Note that it is more traditional to write the diagram in Figure 5-3 with the arrows going from left to right as in Figure 5-4.

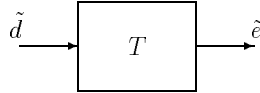

**Figure 5-3: Unweighted MIMO System: Vectors from Left to Right**

The diagrams in Figure 5-3 and Figure 5-4 represent the exact same system. We prefer to write these block diagrams with the arrows going right to left to be consistent with matrix and operator composition.

Assume that the dimensions of  $T$  are  $n_e \times n_d$ . Let  $\beta > 0$  be defined as

$$\beta := \|T\|_\infty := \max_{w \in \mathbf{R}} \bar{\sigma}[T(j\omega)] \quad (5-1)$$

Now consider a response, starting from initial condition equal to 0. In that case, Parseval's theorem gives that

$$\frac{\|\tilde{e}\|_2}{\|\tilde{d}\|_2} = \frac{\left[ \int_0^\infty \tilde{e}^T(t) \tilde{e}(t) dt \right]^{1/2}}{\left[ \int_0^\infty \tilde{d}^T(t) \tilde{d}(t) dt \right]^{1/2}} \leq \beta$$

Moreover, there are specific disturbances  $d$  that result in the ratio  $\frac{\|\tilde{e}\|_2}{\|\tilde{d}\|_2}$

arbitrarily close to  $\beta$ . Because of this,  $\|T\|_\infty$  is referred to as the  $L_2$  (or RMS) gain of the system.

As you would expect, a sinusoidal, steady-state interpretation of  $\|T\|_\infty$  is also possible: For any frequency  $\bar{\omega} \in \mathbf{R}$ , any vector of amplitudes  $a \in \mathbf{R}_{n_d}$ , and any vector of phases  $\phi \in \mathbf{R}^{n_d}$ , with  $\|a\|_2 \leq 1$ , define a time signal

$$\tilde{d}(t) = \begin{bmatrix} a_1 \sin(\bar{\omega}t + \phi_1) \\ \vdots \\ a_{n_d} \sin(\bar{\omega}t + \phi_{n_d}) \end{bmatrix}$$

Applying this input to the system  $T$  results in a steady-state response  $\tilde{e}_{ss}$  of the form

$$\tilde{e}_{ss}(t) = \begin{bmatrix} b_1 \sin(\bar{\omega}t + \phi_1) \\ \vdots \\ b_{n_e} \sin(\bar{\omega}t + \phi_{n_e}) \end{bmatrix}$$

The vector  $b \in \mathbf{R}^{n_e}$  will satisfy  $\|b\|_2 \leq \beta$ . Moreover,  $\beta$ , as defined in equation Figure 5-4, is the smallest number such that this fact is true for every  $\|a\|_2 \leq 1$ ,  $\bar{\omega}$ , and  $\phi$ .

Note that in this interpretation, the vectors of the sinusoidal magnitude responses are unweighted, and measured in Euclidean norm. If realistic multivariable performance objectives are to be represented by a single, MIMO  $\|\cdot\|_\infty$  objective on a closed-loop transfer function, additional scalings are necessary. Since many different objectives are being lumped into one matrix and the associated cost is the norm of the matrix, it is important to use frequency-dependent weighting functions, so that different requirements can be meaningfully combined into a single cost function. Diagonal weights are most easily interpreted.

Consider the diagram of Figure 5-4, along with Figure 5-3.

Assume that  $W_L$  and  $W_R$  are diagonal, stable transfer function matrices, with diagonal entries denoted  $L_i$  and  $R_i$ .

$$W_L = \begin{bmatrix} L_1 & 0 & \dots & 0 \\ 0 & L_2 & \dots & 0 \\ \vdots & \vdots & \ddots & \vdots \\ 0 & 0 & \dots & L_{n_e} \end{bmatrix}, \quad W_R = \begin{bmatrix} R_1 & 0 & \dots & 0 \\ 0 & R_2 & \dots & 0 \\ \vdots & \vdots & \ddots & \vdots \\ 0 & 0 & \dots & R_{n_d} \end{bmatrix}$$

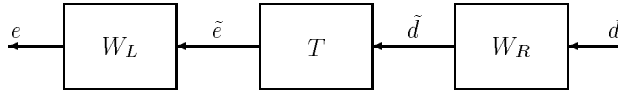

$$e = W_L \tilde{e} = W_L T \tilde{d} = W_L T W_R d$$

**Figure 5-4: Weighted MIMO System**

Bounds on the quantity  $\|W_L T W_R\|_\infty$  will imply bounds about the sinusoidal steady-state behavior of the signals  $\tilde{d}$  and  $\tilde{e}(= T\tilde{d})$  in Figure 5-3. Specifically, for sinusoidal signal  $\tilde{d}$ , the steady-state relationship between  $\tilde{e}(= T\tilde{d})$ ,  $\tilde{d}$  and  $\|W_L T W_R\|_\infty$  is as follows: The steady-state solution  $\tilde{e}_{ss}$ , denoted as

$$\tilde{e}_{ss}(t) = \begin{bmatrix} \tilde{e}_1 \sin(\bar{\omega}t + \phi_1) \\ \vdots \\ \tilde{e}_{n_e} \sin(\bar{\omega}t + \phi_{n_e}) \end{bmatrix} \quad (5-2)$$

satisfies  $\sum_{i=1}^{n_e} |W_{L_i}(j\bar{\omega})\tilde{e}_i|^2 \leq 1$  for all sinusoidal input signals  $\tilde{d}$  of the form

$$\tilde{d}(t) = \begin{bmatrix} \tilde{d}_1 \sin(\bar{\omega}t + \phi_1) \\ \vdots \\ \tilde{d}_{n_d} \sin(\bar{\omega}t + \phi_{n_d}) \end{bmatrix} \quad (5-3)$$

satisfying

$$\sum_{i=1}^{n_d} \frac{|\tilde{d}_i|^2}{|W_{R_i}(j\bar{\omega})|^2} \leq 1$$

if and only if  $\|W_L T W_R\|_\infty \leq 1$ .

This approximately (*very* approximately — the next statement is not actually correct) implies that  $\|W_L T W_R\|_\infty \lesssim 1$  if and only if for every fixed frequency  $\bar{\omega}$ , and all sinusoidal disturbances  $d$  of the form (5-3) satisfying

$$|\tilde{d}_i| \leq |W_{R_i}(j\bar{\omega})|$$

the steady-state error components will satisfy

$$|\tilde{e}_i| \leq \frac{1}{|W_{L_i}(j\bar{\omega})|}$$

This shows how one could pick performance weights to reflect the desired frequency-dependent performance objective. Use  $W_R$  to represent the relative magnitude of sinusoids disturbances that might be present, and use  $\frac{1}{W_L}$  to represent the desired upper bound on the subsequent errors that are produced.

*Remember, though*, the weighted  $H_\infty$  norm does *not* actually give element-by-element bounds on the components of  $\tilde{e}$  based on element-by-element bounds on the components of  $d$ . The precise bound it gives is in terms of Euclidean norms of the components of  $\tilde{e}$  and  $d$  (weighted appropriately by  $W_L(j\bar{\omega})$  and  $W_R(j\bar{\omega})$ ).

## References

- [BalPac:] Balas, G.J. and A.K. Packard, "The structured singular value  $\mu$ -framework," CRC Controls Handbook, Section 2.3.6, pp. 671-688, January, 1996.
- [BallC:] Ball, J.A. and N. Cohen, "Sensitivity minimization in an  $H_\infty$  norm: Parametrization of all suboptimal solutions," *International Journal of Control*, vol. 46, pp. 785-816, 1987.
- [BamP:] Bamieh, B.A. and J.B. Pearson, "A general framework for linear periodic systems with applications to  $H_\infty$  sampled-data control," *IEEE Transactions on Automatic Control*, vol. AC-37, pp. 418-435, 1992.
- [DGKF:] Doyle, J.C., K. Glover, P. Khargonekar, and B. Francis, "State-space solutions to standard  $H_2$  and  $H_\infty$  control problems," *IEEE Transactions on Automatic Control*, vol. AC-34, no. 8, pp. 831-847, August 1989.
- [FialBal:] Fialho, I. and G.J. Balas, "Design of nonlinear controllers for active vehicle suspensions using parameter-varying control synthesis," *Vehicle Systems Dynamics*, vol. 33, no. 5, May 2000, pp. 351-370.
- [Fran1:] Francis, B.A., *A course in  $H_\infty$  control theory*, Lecture Notes in Control and Information Sciences, vol. 88, Springer-Verlag, Berlin, 1987.
- [GloD:] Glover, K. and J.C. Doyle, "State-space formulae for all stabilizing controllers that satisfy an  $H_\infty$  norm bound and relations to risk sensitivity," *Systems and Control Letters*, vol. 11, pp. 167-172, August 1989. *International Journal of Control*, vol. 39, pp. 1115-1193, 1984.
- [Hedrick90:] Hedrick, J.K. and Batsuen, T., "Invariant Properties of Automotive Suspensions," *Proceedings of The Institution of Mechanical Engineers*, 204 (1990), pp. 21-27.
- [Lin971:] Lin, J. and Kanellakopoulos, I., "Road Adaptive Nonlinear Design of Active Suspensions," *Proceedings of the American Control Conference*, (1997), pp. 714-718.
- [PacDB:] Packard, A.K., J.C. Doyle, and G.J. Balas, "Linear, multivariable robust control with a  $\mu$  perspective," *ASME Journal of Dynamics, Measurements and Control: Special Edition on Control*, vol. 115, no. 2b, June, 1993, pp. 426-438.

[SkoP:] Skogestad, S. and I. Postlethwaite, *Multivariable Feedback Control: Analysis & Design*, John Wiley & Sons, 1996.

[SteD:] Stein, G., and J. Doyle, "Beyond singular values and loopshapes," *AIAA Journal of Guidance and Control*, vol. 14, num. 1, pp. 5-16, January, 1991.

[Zame:] Zames, G., "Feedback and optimal sensitivity: model reference transformations, multiplicative seminorms, and approximate inverses," *IEEE Transactions on Automatic Control*, vol. AC-26, pp. 301-320, 1981.



# Building Uncertain Models

---

Introduction to Uncertain Atoms (p. 6-2)	How to build uncertain real, complex, and LTI uncertain matrices, dynamics, and systems
Uncertain Matrices (p. 6-19)	How to manipulate matrices used in systems with structured uncertainty
Uncertain State-Space Systems (uss) (p. 6-25)	Building systems with uncertain state-space matrices and/or uncertain linear dynamics
Uncertain frd (p. 6-33)	Discusses uncertain frequency response data (frd) objects
Basic Control System Toolbox Interconnections (p. 6-37)	A list of Control System Toolbox interconnection commands that work with uncertain objects
Simplifying Representation of Uncertain Objects (p. 6-38)	How to simplify representations of uncertain objects in your models
Sampling Uncertain Objects (p. 6-42)	How to randomly sample uncertain objects
Substitution by usubs (p. 6-46)	How to fix a subset of uncertain objects in your model while leaving the rest uncertain
Array Management for Uncertain Objects (p. 6-49)	Working with multidimensional arrays containing uncertain objects
Decomposing Uncertain Objects (for Advanced Users) (p. 6-60)	Discusses advanced decomposition techniques

## Introduction to Uncertain Atoms

Uncertain atoms are the building blocks used to form uncertain matrix objects and uncertain system objects. There are 5 classes of uncertain atoms:

Function	Description
<code>ureal</code>	Uncertain real parameter
<code>ultidyn</code>	Uncertain, linear, time-invariant dynamics
<code>ucomplex</code>	Uncertain complex parameter
<code>ucomplexm</code>	Uncertain complex matrix
<code>udyn</code>	Uncertain dynamic system

All of the atoms have properties, which are accessed through `get` and `set` methods. This `get` and `set` interface mimics the Control System Toolbox and MATLAB Handle Graphics® behavior. For instance, `get(a, 'PropertyName')` is the same as `a.PropertyName`, and `set(b, 'PropertyName', Value)` is the same as `b.PropertyName = value`. Functionality also includes tab-completion and case-insensitive, partial name property matching.

For `ureal`, `ucomplex` and `ucomplexm` atoms, the syntax is

```
p1 = ureal(name, NominalValue, Prop1, val1, Prop2, val2,...);
p2 = ucomplex(name, NominalValue, Prop1, val1, Prop2, val2,...);
p3 = ucomplexm(name, NominalValue, Prop1, val1, Prop2,
val2,...);
```

For `ultidyn` and `udyn`, the `NominalValue` is fixed, so the syntax is

```
p4 = ultidyn(name, ioSize, Prop1, val1, Prop2, val2,...);
p5 = udyn(name, ioSize, Prop1, val1, Prop2, val2,...);
```

For `ureal`, `ultidyn`, `ucomplex` and `ucomplexm` atoms, the command `usample` will generate a random instance (i.e., not uncertain) of the atom, within its modeled range. For example,

```
usample(p1)
```

creates a random instance of the uncertain real parameter p1. With an integer argument, whole arrays of instances can be created. For instance

```
usample(p4, 100)
```

generates an array of 100 instances of the `ultidyn` object p4. See the section “Sampling Uncertain Objects” on page 6-42 to learn more about `usample`.

## Uncertain Real Parameters

An uncertain real parameter is used to represent a real number whose value is uncertain. Uncertain real parameters have a name (the `Name` property), and a nominal value (the `NominalValue` property). Several other properties (`PlusMinus`, `Range`, `Percentage`) describe the uncertainty in the parameter's value.

All properties of a `ureal` can be accessed through `get` and `set`. The properties are:

Properties	Meaning	Class
Name	Internal Name	char
NominalValue	Nominal value of atom	double
Mode	Signifies which description (from 'PlusMinus', 'Range', 'Percentage') of uncertainty is invariant when NominalValue is changed	char
PlusMinus	Additive variation	scalar or 1x2 double
Range	Numerical range	1x2 double
Percentage	Additive variation (% of absolute value of nominal)	scalar or 1x2 double
AutoSimplify	'off'   {'basic'}   'full'	char

The properties `Range`, `Percentage` and `PlusMinus` are all automatically synchronized. If the nominal value is 0, then the `Mode` cannot be `Percentage`. The `Mode` property controls what aspect of the uncertainty remains unchanged when `NominalValue` is changed. Assigning to any of `Range/Percentage/PlusMinus` changes the value, *but does not* change the mode.

The `AutoSimplify` property controls how expressions involving the real parameter are simplified. Its default value is `'basic'`, which means elementary methods of simplification are applied as operations are completed. Other values for `AutoSimplify` are `'off'` (no simplification performed) and `'full'` (model-reduction-like techniques are applied). See the section “Simplifying Representation of Uncertain Objects” on page 6-38 to learn more about the `AutoSimplify` property and the command `simplify`.

If no property/value pairs are specified, default values are used. The default `Mode` is `PlusMinus`, and the default value of `PlusMinus` is `[-1 1]`. Some examples are shown below. In many cases, the full property name is not specified, taking advantage of the case-insensitive, partial name property matching.

Create an uncertain real parameter, nominal value 3, with default values for all unspecified properties (including plus/minus variability of 1). View the properties and their values, and note that the `Range` and `Percentage` descriptions of variability are automatically maintained.

```
a = ureal('a',3)
```

```
Uncertain Real Parameter: Name a, NominalValue 3, variability =  
[-1 1]
```

```
get(a)
```

```
      Name: 'a'  
      NominalValue: 3  
      Mode: 'PlusMinus'  
      Range: [2 4]  
      PlusMinus: [-1 1]  
      Percentage: [-33.3333 33.3333]  
      AutoSimplify: 'basic'
```

Create an uncertain real parameter, nominal value 2, with 20% variability. Again, view the properties, and note that the `Range` and `PlusMinus` descriptions of variability are automatically maintained.

```

b = ureal('b',2,'percentage',20)
Uncertain Real Parameter: Name b, NominalValue 2, variability =
[-20 20]%
get(b)
      Name: 'b'
NominalValue: 2
      Mode: 'Percentage'
      Range: [1.6000 2.4000]
      PlusMinus: [-0.4000 0.4000]
      Percentage: [-20.0000 20.0000]
AutoSimplify: 'basic'

```

Change the range of the parameter. All descriptions of variability are automatically updated, while the nominal value remains fixed. Although the change in variability was accomplished by specifying the Range, the Mode is unaffected, and remains Percentage.

```

b.Range = [1.9 2.3];
get(b)
      Name: 'b'
NominalValue: 2
      Mode: 'Percentage'
      Range: [1.9000 2.3000]
      PlusMinus: [-0.1000 0.3000]
      Percentage: [-5.0000 15.0000]
AutoSimplify: 'basic'

```

As mentioned, the Mode property signifies what aspect of the uncertainty remains unchanged when NominalValue is modified. Hence, if a real parameter is in Percentage mode, then the Range and PlusMinus properties are determined from the Percentage property and NominalValue. Changing NominalValue preserves the Percentage property, and automatically updates the Range and PlusMinus properties.

```

b.NominalValue = 2.2;
get(b)
      Name: 'b'
NominalValue: 2.2000
      Mode: 'Percentage'
      Range: [2.0900 2.5300]
      PlusMinus: [-0.1100 0.3300]

```

```
Percentage: [-5.0000 15.0000]
AutoSimplify: 'basic'
```

Create an uncertain parameter with an unsymmetric variation about its nominal value.

```
c = ureal('c',-5,'per',[-20 30]);
get(c)
    Name: 'c'
NominalValue: -5
    Mode: 'Percentage'
    Range: [-6 -3.5000]
    PlusMinus: [-1 1.5000]
    Percentage: [-20 30]
AutoSimplify: 'basic'
```

Create an uncertain parameter, specifying variability with Percentage, but force the Mode to be Range.

```
d = ureal('d',-1,'mode','range','perc',[-40 60]);
get(d)
    Name: 'd'
NominalValue: -1
    Mode: 'Range'
    Range: [-1.4000 -0.4000]
    PlusMinus: [-0.4000 0.6000]
    Percentage: [-40.0000 60]
AutoSimplify: 'basic'
```

Finally, create an uncertain real parameter, and set the AutoSimplify property to 'full'.

```
e = ureal('e',10,'plusminus',[-23],'mode','perce',...
'autosimplify','full')
Uncertain Real Parameter: Name e, NominalValue 10, variability
= [-20 30]%
get(e)
    Name: 'e'
NominalValue: 10
    Mode: 'Percentage'
    Range: [8 13]
    PlusMinus: [-2 3]
```

```
Percentage: [-20 30]
AutoSimplify: 'full'
```

Specifying conflicting values for Range/Percentage/PlusMinus in a multiple property/value set is not an error. In this case, the last (in list) specified property is used. This last occurrence also determines the Mode, unless Mode is explicitly specified, in which case that is used, regardless of the property/value pairs ordering.

```
f = ureal('f',3,'plusminus',[-2 1],'perce',40)
Uncertain Real Parameter: Name f, NominalValue 3, variability =
[-40 40]%
g = ureal('g',2,'plusminus',[-2 1],'mode','range','perce',40)
Uncertain Real Parameter: Name g, NominalValue 2, Range [1.2
2.8]
g.Mode
ans =
Range
```

Create an uncertain real parameter, use `usample` to generate 1000 instances (resulting in a 1-by-1-by-1000 array), reshape the array, and plot a histogram, with 20 bins (within the range of 2-to-4).

```
h = ureal('h',3);
hsample = usample(h,1000);
hist(reshape(hsample,[1000 1]),20);
```

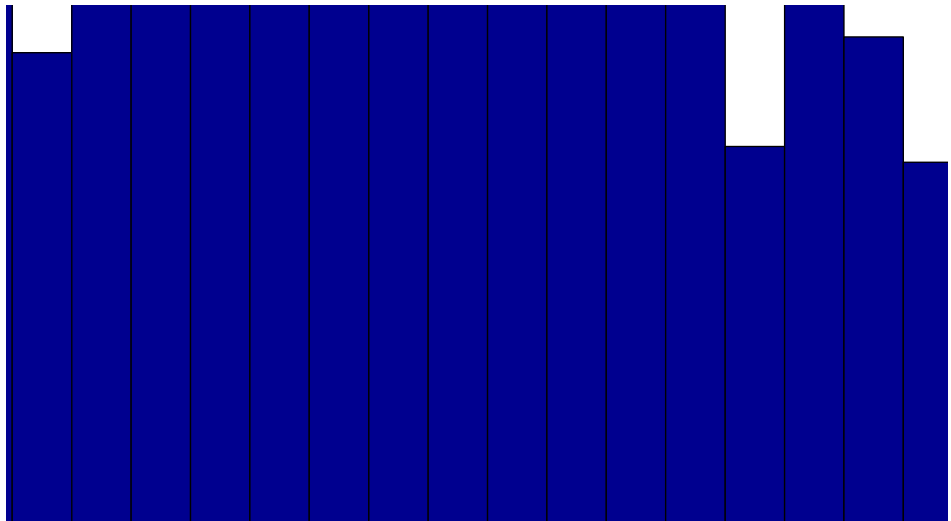

Make the range unsymmetric about the nominal value, and repeat the sampling, and histogram plot (with 40 bins over the range of 2-to-6)

```
h.Range = [2 6];  
hsample = usample(h,1000);  
hist(reshape(hsample,[1000 1]),40);
```



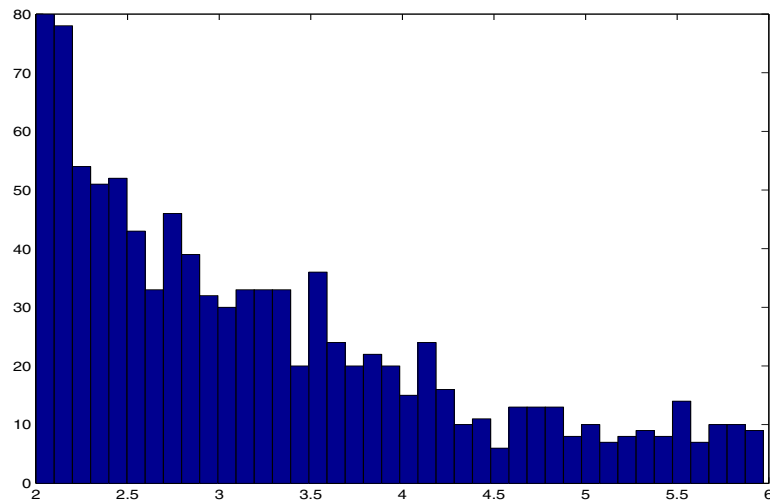

Note that the distribution is skewed. However, the number of samples less than the nominal value and the number of samples greater than the nominal value is equal (on average). Verify this.

```
length(find(hsample(:)<h.NominalValue))
ans =
    509
length(find(hsample(:)>h.NominalValue))
ans =
    491
```

The distribution used in `usample` is uniform in the normalized description of the uncertain real parameter. See the section “Decomposing Uncertain Objects (for Advanced Users)” on page 6-60 to learn more about the normalized description.

There is no notion of an empty `ureal` (or any other atom, for that matter). `ureal`, by itself, creates an unnamed atom, with default property values. The given name is 'UNNAMED'. This can be observed with `get` and `set`.

```
get(ureal)
    Name: 'UNNAMED'
    NominalValue: 0
    Mode: 'PlusMinus'
```

```
        Range: [-1 1]
        PlusMinus: [-1 1]
        Percentage: [-Inf Inf]
        AutoSimplify: 'basic'
set(ureal)
        Name: 'String'
        NominalValue: '1x1 real DOUBLE'
        Mode: 'Range | PlusMinus'
        Range: '1x2 DOUBLE'
        PlusMinus: '1x2 or scalar DOUBLE'
        Percentage: 'Not settable since Nominal==0'
        AutoSimplify: '['off' | 'basic' | 'full']'
```

## Uncertain LTI Dynamics Atoms

Uncertain linear, time-invariant objects, `ultidyn`, are used to represent unknown linear, time-invariant dynamic objects, whose only known attributes are bounds on their frequency response. Uncertain linear, time-invariant objects have an internal name (the `Name` property), and are created by specifying their size (number of outputs and number of inputs).

The property `Type` specifies whether the known attributes about the frequency response are related to gain or phase. The property `Type` may be `'GainBounded'` or `'PositiveReal'`. The default value is `'GainBounded'`.

The property `Bound` is a single number, which along with `Type`, completely specifies what is known about the uncertain frequency response. Specifically, if  $\Delta$  is an `ultidyn` atom, and if  $\gamma$  denotes the value of the `Bound` property, then the atom represents the set of all stable, linear, time-invariant systems whose frequency response satisfies certain conditions:

If `Type` is `'GainBounded'`,  $\sigma[\Delta(\omega)] \leq \gamma$  for all frequencies. When `Type` is `'GainBounded'`, the default value for `Bound` (i.e.,  $\gamma$ ) is 1. The `NominalValue` of  $\Delta$  is always the 0-matrix.

If `Type` is `'PositiveReal'`,  $\Delta(\omega) + \Delta^*(\omega) \geq 2\gamma I$  for all frequencies. When `Type` is `'PositiveReal'`, the default value for `Bound` (i.e.,  $\gamma$ ) is 0. The `NominalValue` is always  $(\gamma + 1 + 2|\gamma|)I$ .

All properties of a `ultidyn` are can be accessed with `get` and `set` (although the `NominalValue` is determined from `Type` and `Bound`, and not accessible with `set`). The properties are

Properties	Meaning	Class
<code>Name</code>	Internal Name	char
<code>NominalValue</code>	Nominal value of atom	See above
<code>Type</code>	'GainBounded'   'PositiveReal'	char
<code>Bound</code>	Norm bound or minimum real	scalar double
<code>SampleStateDim</code>	State-space dimension of random samples of this uncertain element	scalar double
<code>AutoSimplify</code>	'off'   {'basic'}   'full'	char

The `SampleStateDim` property specifies the state dimension of random samples of the atom when using `usample`. The default value is 1. The `AutoSimplify` property serves the same function as in the uncertain real parameter.

You can create a 2-by-3 gain-bounded uncertain linear dynamics atom. Verify its size, and check the properties.

```
f = ultidyn('f',[2 3]);
size(f)
ans =
     2     3
get(f)
      Name: 'f'
  NominalValue: [2x3 double]
        Type: 'GainBounded'
        Bound: 1
  SampleStateDim: 1
  AutoSimplify: 'basic'
```

You can create a 1-by-1 (scalar) positive-real uncertain linear dynamics atom, whose frequency response always has real part greater than -0.5. Set the

SampleStateDim property to 5. View the properties, and plot a Nyquist plot of 30 instances of the atom.

```
g = ultidyn('g',[1 1],'type','positivereal','bound',-0.5);
g.SampleStateDim = 5;
get(g)
    Name: 'g'
    NominalValue: 1.5000
    Type: 'PositiveReal'
    Bound: -0.5000
    SampleStateDim: 5
    AutoSimplify: 'basic'
nyquist(usample(g,30))
xlim([-2 10])
ylim([-6 6]);
```

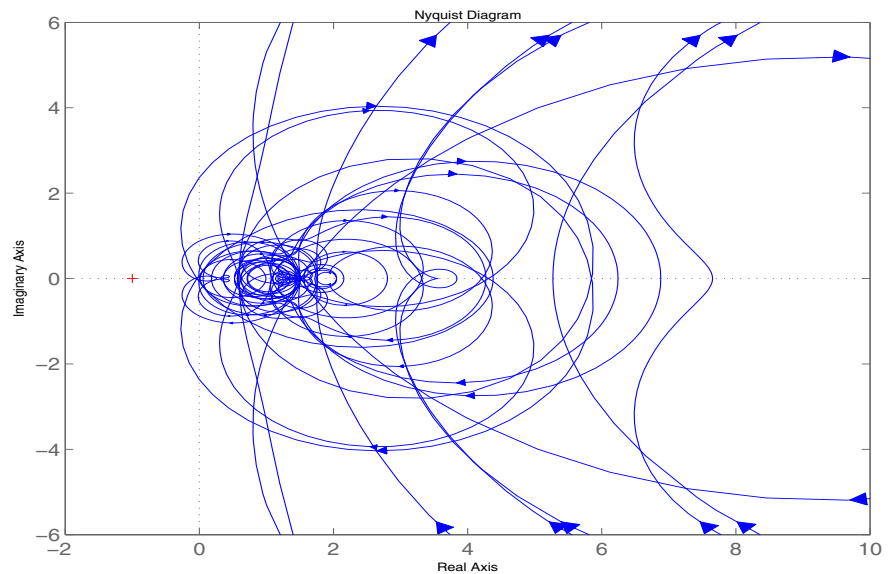

### Time-domain of ultidyn atoms

On its own, every ultidyn atom is interpreted as a continuous-time, system with uncertain behavior, quantified by bounds (gain or real-part) on its

frequency response. To see this, create a `ultidyn`, and view the sample time of several random samples of the atom.

```
h = ultidyn('h',[1 1]);
get(usample(h),'Ts')
ans =
    0
get(usample(h),'Ts')
ans =
    0
get(usample(h),'Ts')
ans =
    0
```

However, when a `ultidyn` atom is an uncertain element of an uncertain state space model (`uss`), then the time-domain characteristic of the atom is determined from the time-domain characteristic of the system. The bounds (gain-bounded or positivity) apply to the frequency-response of the atom. SEE the section “Interpreting Uncertainty in Discrete Time” on page 6-30 for more information.

## Complex Parameter Atoms

The `ucomplex` atom represents an uncertain complex number, whose value lies in a disc, centered at `NominalValue`, with radius specified by the `Radius` property. The size of the disc can also be specified by `Percentage`, which means the radius is derived from the absolute value of the `NominalValue`. The properties of `ucomplex` objects are

Properties	Meaning	Class
Name	Internal Name	char
NominalValue	Nominal value of atom	double
Mode	'Range'   'Percentage'	char
Radius	Radius of disk	double

Properties	Meaning	Class
Percentage	Additive variation (percent of Radius)	double
AutoSimplify	'off'   {'basic'}   'full'	char

The simplest construction requires only a name and nominal value. The default Mode is Radius, and the default radius is 1.

```
a = ucomplex('a',2-j)
Uncertain Complex Parameter: Name a, NominalValue 2-1i, Radius 1
get(a)
    Name: 'a'
    NominalValue: 2.0000- 1.0000i
    Mode: 'Radius'
    Radius: 1
    Percentage: 44.7214
    AutoSimplify: 'basic'
set(a)
    Name: 'String'
    NominalValue: '1x1 DOUBLE'
    Mode: 'Radius | Percentage'
    Radius: 'scalar DOUBLE'
    Percentage: 'scalar DOUBLE'
    AutoSimplify: '['off' | 'basic' | 'full']'
```

Sample the uncertain complex parameter at 400 values, and plot in the complex plane. Clearly, the samples appear to be from a disc of radius 1, centered in the complex plane at the value  $2-j$ .

```
asample = usample(a,400);
plot(asample(:),'o'); xlim([0 4]); ylim([-3 1]);
```

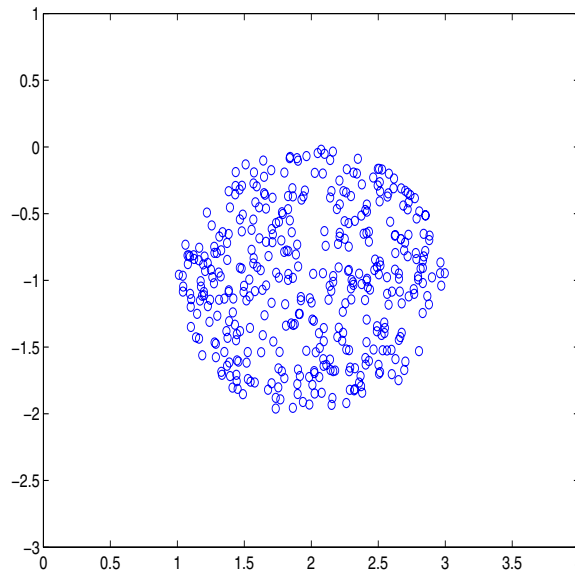

## Complex Matrix Atoms

The uncertain complex matrix class, `ucomplexm`, represents the set of matrices given by the formula

$$N + W_L \Delta W_R$$

where  $N, W_L, W_R$  are known matrices, and  $\Delta$  is any complex matrix with

$\sigma(\Delta) \leq 1$ . All properties of a `ucomplexm` are can be accessed with `get` and `set`. The properties are

Properties	Meaning	Class
Name	Internal Name	char
NominalValue	Nominal value of atom	double
WL	Left weight	double

Properties	Meaning	Class
WR	Right weight	double
AutoSimplify	'off'   {'basic'}   'full'	char

The simplest construction requires only a name and nominal value. The default left and right weight matrices are identity.

You can create a 4-by-3 `ucomplexm` element, and view its properties.

```
m = ucomplexm('m',[1 2 3;4 5 6;7 8 9;10 11 12])
Uncertain Complex Matrix: Name m, 4x3
get(m)
    Name: 'm'
    NominalValue: [4x3 double]
           WL: [4x4 double]
           WR: [3x3 double]
    AutoSimplify: 'basic'
m.NominalValue
ans =
     1     2     3
     4     5     6
     7     8     9
    10    11    12
m.WL
ans =
     1     0     0     0
     0     1     0     0
     0     0     1     0
     0     0     0     1
```

Sample the uncertain matrix, and compare to the nominal value. Note the element-by-element sizes of the difference are generally equal, indicative of the default (identity) weighting matrices that are in place.

```
abs(usample(m) - m.NominalValue)
ans =
    0.2948    0.1001    0.2867
    0.3028    0.2384    0.2508
    0.3376    0.1260    0.2506
```



```
0.2200    0.3472    0.1657
```

Change the left and right weighting matrices, making the uncertainty larger as you move down the rows, and across the columns.

```
m.WL = diag([0.2 0.4 0.8 1.6]);
m.WR = diag([0.1 1 4]);
```

Sample the uncertain matrix, and compare to the nominal value. Note the element-by-element sizes of the difference, and the general trend that the smallest differences are near the (1,1) element, and the largest differences are near the (4,3) element, which is completely expected by choice of the diagonal weighting matrices.

```
abs(usample(m) - m.NominalValue)
ans =
    0.0091    0.0860    0.2753
    0.0057    0.1717    0.6413
    0.0304    0.2756    1.4012
    0.0527    0.4099    1.8335
```

## Unstructured Uncertain Dynamic Systems

The unstructured uncertain dynamic system class, `udyn`, represents completely unknown multivariable, time-varying nonlinear systems.

For practical purposes, these uncertain elements represent noncommuting symbolic variables (placeholders). All algebraic operations, such as addition, subtraction, multiplication (i.e., cascade) operate properly, and substitution (with `usubs`) is allowed. However, all of the analysis tools (e.g., `robuststab`) do not handle these types of uncertain elements. As such, these elements do not provide a significant amount of usability, and their role in the user's guide is small.

You can create a 2-by-3 `udyn` element. Check its size, and properties.

```
m = udyn('m',[2 3])
Uncertain Dynamic System: Name m, size 2x3
size(m)
ans =
     2     3
get(m)
      Name: 'm'
```

```
NominalValue: [2x3 double]  
AutoSimplify: 'basic'
```

## Uncertain Matrices

Uncertain matrices (class `umat`) are built from doubles, and uncertain atoms, using traditional MATLAB matrix building syntax. Uncertain matrices can be added, subtracted, multiplied, inverted, transposed, etc., resulting in uncertain matrices. The rows and columns of an uncertain matrix are referenced in the same manner that MATLAB references rows and columns of an array, using parenthesis, and integer indices. The `NominalValue` of a uncertain matrix is the result obtained when all uncertain atoms are replaced with their own `NominalValue`. The uncertain atoms making up a `umat` are accessible through the `Uncertainty` gateway, and the properties of each atom within a `umat` can be changed directly.

Using `usubs`, specific values may be substituted for any of the uncertain atoms within a `umat`. The command `usample` generates a random sample of the uncertain matrix, substituting random samples (within their ranges) for each of the uncertain atoms.

The command `wcnorm` computes tight bounds on the worst-case (maximum over the uncertain elements' ranges) norm of the uncertain matrix.

Standard MATLAB numerical matrices (i.e., `double`) naturally can be viewed as uncertain matrices without any uncertainty.

### Creating Uncertain Matrices from Uncertain Atoms

You can create 2 uncertain real parameters, and then a 3-by-2 uncertain matrix using these uncertain atoms.

```
a = ureal('a',3);
b = ureal('b',10,'pe',20);
M = [-a 1/b;b a+1/b;1 3]
UMAT: 3 Rows, 2 Columns
  a: real, nominal = 3, variability = [-1 1], 2 occurrences
  b: real, nominal = 10, variability = [-20 20]%, 3 occurrences
```

The size and class of `M` are as expected

```
size(M)
ans =
     3     2
class(M)
ans =
```

```
umat
```

## Accessing Properties of a umat

Use `get` to view the accessible properties of a `umat`.

```
get(M)
  NominalValue: [3x2 double]
  Uncertainty: [1x1 atomlist]
```

The `NominalValue` is a `double`, obtained by replacing all uncertain elements with their nominal values.

```
M.NominalValue
ans =
   -3.0000    0.1000
   10.0000    3.1000
    1.0000    3.0000
```

The `Uncertainty` property is a `atomlist` object, which is simply a gateway from the `umat` to the uncertain atoms.

```
class(M.Uncertainty)
ans =
atomlist
M.Uncertainty
  a: [1x1 ureal]
  b: [1x1 ureal]
```

Direct access to the atoms is facilitated through `Uncertainty`. Check the `Range` of the uncertain element named 'a' within `M`, then change it.

```
M.Uncertainty.a.Range
ans =
     2     4
M.Uncertainty.a.Range = [2.5 5];
M
UMAT: 3 Rows, 2 Columns
  a: real, nominal = 3, variability = [-0.5 2], 2 occurrences
  b: real, nominal = 10, variability = [-20 20]%, 3 occurrences
```

The change to the uncertain real parameter `a` only took place within `M`. Verify that the variable `a` in the workspace is no longer the same as the variable `a` within `M`.

```
isequal(M.Uncertainty.a,a)
ans =
    0
```

Note that combining atoms which have a common internal name, but different properties leads to an error. For instance, subtracting the two atoms gives an error, not 0.

```
M.Uncertainty.a - a
??? Error using ==> ndlft.lftmask
```

Atoms named 'a' have different properties.

## Row and Column Referencing

Standard Row/Column referencing is allowed. Note, however, that single-indexing is only allowed if the `umat` is a column or a row.

Reconstruct `M` (if need be), and make a 2-by-2 selection from `M`

```
a = ureal('a',3);
b = ureal('b',10,'pe',20);
M = [-a 1/b;b a+1/b;1 3];
M.Uncertainty.a.Range = [2.5 5];
M(2:3,:)
UMAT: 2 Rows, 2 Columns
  a: real, nominal = 3, variability = [-0.5 2], 1 occurrence
  b: real, nominal = 10, variability = [-20 20]%, 2 occurrences
```

Make a single column selection from `M`, and use single-index references to access elements of it.

```
h = M([2 1 2 3],2)
UMAT: 4 Rows, 1 Columns
  a: real, nominal = 3, variability = [-0.5 2], 1 occurrence
  b: real, nominal = 10, variability = [-20 20]%, 1 occurrence
h(2)
UMAT: 1 Rows, 1 Columns
  b: real, nominal = 10, variability = [-20 20]%, 1 occurrence
```

```
h(3)
UMAT: 1 Rows, 1 Columns
  a: real, nominal = 3, variability = [-0.5 2], 1 occurrence
  b: real, nominal = 10, variability = [-20 20]%, 1 occurrence
```

Finally, make the (3,2) entry of M uncertain.

```
M(3,2) = ureal('c',3,'perc',40)
UMAT: 3 Rows, 2 Columns
  a: real, nominal = 3, variability = [-0.5 2], 2 occurrences
  b: real, nominal = 10, variability = [-20 20]%, 2 occurrences
  c: real, nominal = 3, variability = [-40 40]%, 1 occurrence
```

## Matrix Operation on umat Objects

Many matrix operations are allowed, such as matrix-multiply, transpose, and inverse. Combinations of certain (i.e., not uncertain) matrices and uncertain matrices are allowed.

Premultiply M by a 1-by-3 constant matrix, resulting in a 1-by-2 umat.

```
M1 = [2 3 1]*M
UMAT: 1 Rows, 2 Columns
  a: real, nominal = 3, variability = [-0.5 2], 1 occurrence
  b: real, nominal = 10, variability = [-20 20]%, 2 occurrences
  c: real, nominal = 3, variability = [-40 40]%, 1 occurrence
```

Verify that the 1st entry of M1 is  $-2*a + 3*b + 1$ . Direct subtraction yields a umat without any dependence on uncertain elements. Simplifying the class shows that the result is zero as expected.

```
d = M1(1) - (-2*M.Uncertainty.a + 3*M.Uncertainty.b + 1)
UMAT: 1 Rows, 1 Columns
simplify(d,'class')
ans =
    0
```

Transpose M, form a product, an inverse, and sample the uncertain result. As expected, the result is the 2-by-2 identity matrix.

```
H = M.'*M;
K = inv(H);
usample(K*H,3)
```

```
ans(:,:,1) =
    1.0000   -0.0000
   -0.0000    1.0000
ans(:,:,2) =
    1.0000   -0.0000
   -0.0000    1.0000
ans(:,:,3) =
    1.0000   -0.0000
   -0.0000    1.0000
```

## Substituting for Uncertain Atoms

You can substitute for uncertain atoms by using `usubs`, as described in the section “Substitution by `usubs`” on page 6-46. This section describes some special cases.

Substitute all instances of the uncertain real parameter named `a` with the number 4. This results in a `umat`, with dependence on the uncertain real parameters `b` and `c`.

```
M2 = usubs(M,'a',4)
UMAT: 3 Rows, 2 Columns
    b: real, nominal = 10, variability = [-20 20]%, 2 occurrences
    c: real, nominal = 3, variability = [-40 40]%, 1 occurrence
```

Similarly, we can substitute all instances of the uncertain real parameter named `b` with `M.Uncertainty.a`, resulting in a `umat` with dependence on the uncertain real parameters `a` and `c`.

```
M3 = usubs(M,'b', M.Uncertainty.a)
UMAT: 3 Rows, 2 Columns
    a: real, nominal = 3, variability = [-0.5 2], 4 occurrences
    c: real, nominal = 3, variability = [-40 40]%, 1 occurrence
Nominal and/or random instances can easily be specified.
M4 = usubs(M,'a','nominal','b','random')
UMAT: 3 Rows, 2 Columns
    c: real, nominal = 3, variability = [-40 40]%, 1 occurrence
```

If one value is being substituted for many different atoms, the atom names can be listed in a cell array, and then the value given. For example, substitute `a` and `b` with the number 4, and `c` with the number 5.

```
M5 = usubs(M,{'a' 'b'},4,'c',5)
```

```
M5 =  
  -4.0000    0.2500  
   4.0000    4.2500  
   1.0000    5.0000
```

The command `usample` also generates multiple random instances of a `umat` (and `uss` and `ufrd`). See the section “Sampling Uncertain Objects” on page 6-42 for more information.

### Lifting a double matrix to a `umat`

A not-uncertain matrix may be interpreted as an uncertain matrix that has no dependence on uncertain atoms. Use the `umat` command to *lift* a double to the `umat` class.

```
Md = [1 2 3;4 5 6];  
M = umat(Md)  
UMAT: 2 Rows, 3 Columns
```

High dimensional double matrices can also be lifted. Note from the display that once the matrix is interpreted as a `umat`, the 3rd dimension and beyond are interpreted as array dimensions. See the section “Array Management for Uncertain Objects” for more information about how multidimensional arrays of uncertain objects are handled.

```
Md = randn(4,5,6);  
M = umat(Md)  
UMAT: 4 Rows, 5 Columns [array, 6 x 1]  
Md = randn(4,5,6,7);  
M = umat(Md)  
UMAT: 4 Rows, 5 Columns [array, 6 x 7]  
Md = randn(4,5,6,7,8);  
M = umat(Md)  
UMAT: 4 Rows, 5 Columns [array, 6 x 7 x 8]
```



## Uncertain State-Space Systems (uss)

Uncertain systems (uss) are linear systems with uncertain state-space matrices and/or uncertain linear dynamics. Like their certain (i.e., not uncertain) counterpart, the ss object, they are often built from state-space matrices using the ss command. In the case where some of the state-space matrices are uncertain, the result will be a uncertain state-space (uss) object.

Combining uncertain systems with uncertain systems (with the feedback command, for example) usually leads to an uncertain system. Not-uncertain systems can be combined with uncertain systems. Usually the result is an uncertain system.

The nominal value of an uncertain system is the ss object, which is familiar to the users of the Control System Toolbox.

### Creating Uncertain Systems

Uncertain systems (class uss) are built from of certain and/or uncertain state-space matrices, usually using the ss command.

In the example below, the A, B and C matrices are made up of uncertain real parameters. Packing them together with the ss command results in a continuous-time uncertain system.

You can create three uncertain real parameters. Then create 3 uncertain matrices A, B and C, and one double matrix D.

```
p1 = ureal('p1',10,'pe',50);
p2 = ureal('p2',3,'plum',[-.5 1.2]);
p3 = ureal('p3',0);
A = [-p1 p2;0 -p1];
B = [-p2;p2+p3];
C = [1 0;1 1-p3];
D = [0;0];
```

Pack the 4 matrices together using the ss command. This results in a continuous-time 2-output, 1-input, 2-state uncertain system.

```
sys = ss(A,B,C,D)
USS: 2 States, 2 Outputs, 1 Input, Continuous System
p1: real, nominal = 10, variability = [-50 50]%, 2 occurrences
p2: real, nominal = 3, variability = [-0.5 1.2], 2 occurrences
```

```
p3: real, nominal = 0, variability = [-1 1], 2 occurrences
```

## Properties of `uss` Objects

View the properties with the `get` command.

```
get(sys)
      a: [2x2 umat]
      b: [2x1 umat]
      c: [2x2 umat]
      d: [2x1 double]
      StateName: {2x1 cell}
      Ts: 0
      InputName: {' '}
      OutputName: {2x1 cell}
      InputGroup: [1x1 struct]
      OutputGroup: [1x1 struct]
      NominalValue: [2x1 ss]
      Uncertainty: [1x1 atomlist]
      Notes: {}
      UserData: []
```

The properties `a`, `b`, `c`, `d`, and `StateName` behave in exactly the same manner as Control System Toolbox `ss` objects. The properties `InputName`, `OutputName`, `InputGroup` and `OutputGroup` behave in exactly the same manner as all of the Control System Toolbox system objects (`ss`, `zpk`, `tf`, and `frd`).

The `NominalValue` is the `ss` object of the Control System Toolbox, and therefore all methods for `ss` objects are available. For instance, compute the poles and step response of the nominal system.

```
pole(sys.NominalValue)
ans =
    -10
    -10
step(sys.NominalValue)
```

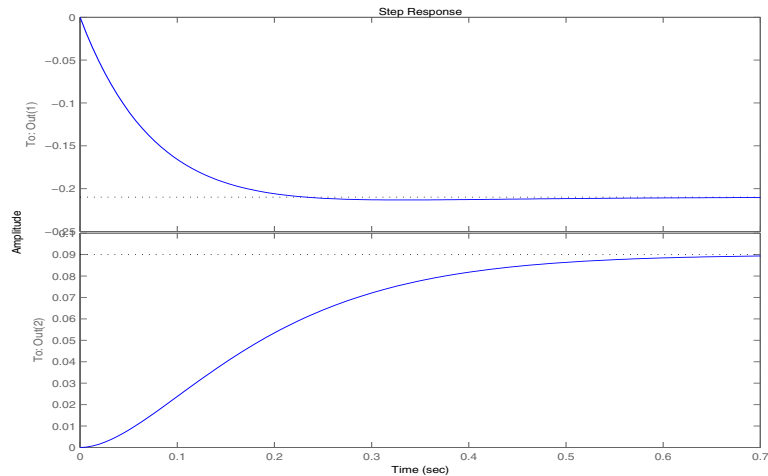

Just as with the `umat` class, the `Uncertainty` property is a `atomlist` object, acting as a gateway to the uncertain atoms. Direct access to the atoms is facilitated through `Uncertainty`. Check the Range of the uncertain element named 'p2' within `sys`, then change its left endpoint.

```
sys.Uncertainty.p2.range
ans =
    2.5000    4.2000
sys.Uncertainty.p2.range(1) = 2;
```

## Sampling Uncertain Systems

The command `usample` randomly samples the uncertain system at a specified number of points.

Randomly sample the uncertain system at 20 points in its modeled uncertainty range. This gives a 20-by-1 `ss` array. Consequently, all analysis tools from the Control System Toolbox are available.

```
manysys = usample(sys,20);
size(manysys)
20x1 array of state-space models
Each model has 2 outputs, 1 input, and 2 states.
step(manysys)
```

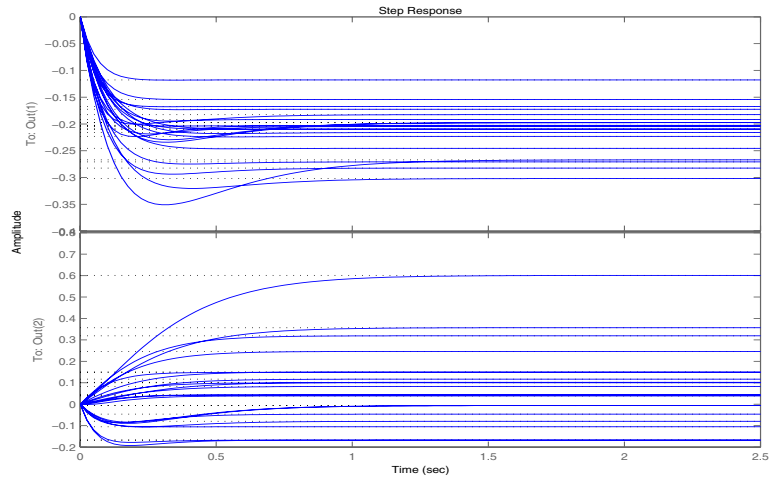

The command `step` can be called directly on a `uss` object. The default behavior samples the `uss` object at 20 instances, and plots the step responses and the nominal value for these 20 models.

The same features are available for `bode`, `bodemag` and `nyquist`.

## Feedback Around Uncertain Plant

It is possible to form interconnections of `uss` objects. A common example is to form the feedback interconnection of a given controller with an uncertain plant.

First create the uncertain plant. Start with two uncertain real parameters.

```
gamma = ureal('gamma',4);
tau = ureal('tau',.5,'Percentage',30);
```

Next, create an unmodeled dynamics atom, `delta`, and a 1st order weighting function, whose DC value is 0.2, high-frequency gain is 10, and whose crossover frequency is 8 rad/sec.

```
delta = ultidyn('delta',[1 1],'SampleStateDim',5);
W = makeweight(0.2,6,6);
```

Finally, create the uncertain plant consisting of the uncertain parameters and the unmodeled dynamics.

```
P = tf(gamma,[tau 1])*(1+W*delta);
```

You can create an integral controller based on nominal plant parameters. Nominally the closed-loop system will have damping ratio of 0.707 and time constant of  $2*\tau$ .

```
KI = 1/(2*tau.Nominal*gamma.Nominal);
C = tf(KI,[1 0]);
```

Create the uncertain closed-loop system using the feedback command.

```
CLP = feedback(P*C,1);
```

Using `usample` and `step`, plot samples of the open-loop and closed-loop step responses. As expected the integral controller reduces the variability in the low frequency response.

```
subplot(2,1,1); step(P,5,20)
subplot(2,1,2); step(CLP,5,20)
```

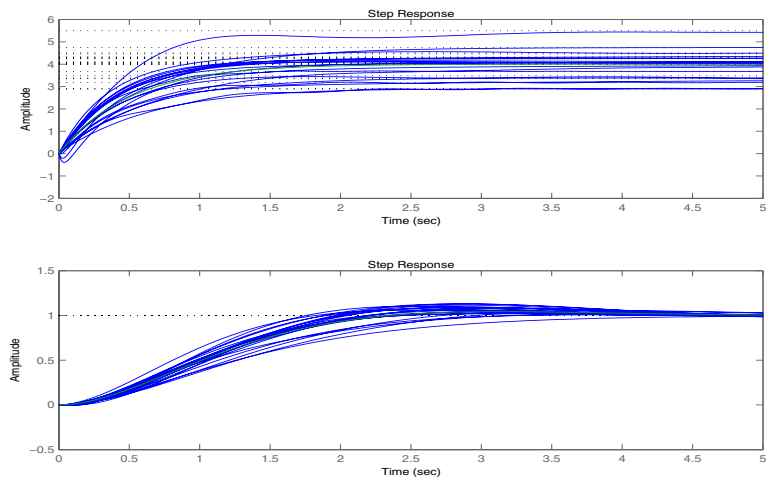

## Interpreting Uncertainty in Discrete Time

The interpretation of a `ultidyn` atom as a continuous-time or discrete-time system depends on the nature of the uncertain system (`uss`) within which it is an uncertain element.

For example, create a scalar `ultidyn` object. Then, create two 1-input, 1-output `uss` objects using the `ultidyn` object as their “D” matrix. In the first case, create without specifying sample-time, which indicates continuous time. In the second case, force discrete-time with a sample time of 0.42.

```
delta = ultidyn('delta',[1 1]);
sys1 = uss([],[],[],delta)
USS: 0 States, 1 Output, 1 Input, Continuous System
    delta: 1x1 LTI, max. gain = 1, 1 occurrence
sys2 = uss([],[],[],delta,0.42)
USS: 0 States, 1 Output, 1 Input, Discrete System, Ts = 0.42
    delta: 1x1 LTI, max. gain = 1, 1 occurrence
```

Next, get a random sample of each system. When obtaining random samples using `usample`, the values of the atoms used in the sample are returned in the 2nd argument from `usample` as a structure.

```
[sys1s,d1v] = usample(sys1);
[sys2s,d2v] = usample(sys2);
```

Look at `d1v.delta.Ts` and `d2v.delta.Ts`. In the first case, since `sys1` is continuous-time, the system `d1v.delta` is continuous-time. In the second case, since `sys2` is discrete-time, with sample time 0.42, the system `d2v.delta` is discrete-time, with sample time 0.42.

```
d1v.delta.Ts
ans =
    0
d2v.delta.Ts
ans =
    0.4200
```

Finally, in the case of a discrete-time `uss` object, it is not the case that `ultidyn` objects are interpreted as continuous-time uncertainty in feedback with sampled-data systems. This very interesting hybrid theory has been studied by many authors, see [DullerudGlover], but it is beyond the scope of the toolbox.

## Lifting a ss to a uss

A non-certain state space object may be interpreted as an uncertain state space object that has no dependence on uncertain atoms. Use the `uss` command to “lift” the `ss` to the `uss` class.

```
sys = rss(3,2,1);
usys = uss(sys)
USS: 3 States, 2 Outputs, 1 Input, Continuous System
```

Arrays of `ss` objects can also be lifted. See the section “Array Management for Uncertain Objects” on page 6-49 for more information about handling arrays of uncertain objects.

## Handling Delays in uss

In the current implementation, delays are not allowed. Delays are omitted and a warning is displayed when `ss` objects are lifted to `uss` objects.

```
sys = rss(3,2,1);
sys.inputdelay = 1.3;
usys = uss(sys)
Warning: Omitting DELAYS in conversion to USS
> In uss.uss at 103
USS: 3 States, 2 Outputs, 1 Input, Continuous System
```

This lifting process happens in the background whenever `ss` objects are combined with any uncertain object. Consequently all delays will be lost in such operations.

Use the command `pade` to approximately preserve the effect of the time delay in the `ss` object. Before operations involving `ss` objects containing delays and uncertain objects, use the `pade` command to convert the `ss` object to a delay free object.

For example, consider an uncertain system with a time constant approximately equal to 1, an extra input delay of 0.3 seconds, second-order rolloff beyond 20 rad/s, and an uncertain steady-state gain ranging from 4 to 6. This can be approximated using the `pade` command as follows.

```
sys = tf(1,[1 1])*tf(1,[0.05 1]);
sys.inputdelay = 0.3;
gain = ureal('gain',5);
usys = gain*pade(sys,4)
```

```
USS: 6 States, 1 Output, 1 Input, Continuous System
gain: real, nominal = 5, variability = [-1 1], 1 occurrence
```

If gain is multiplied by sys directly, the time delay is unfortunately omitted, since this operation involves lifting sys to a uss as described above. The difference is obvious from the step responses.

```
step(usys,gain*sys,4,5)
Warning: Omitting DELAYS in conversion to USS
> In uss.uss at 103
   In umat.umat at 98
   In atom.mtimes at 7
```

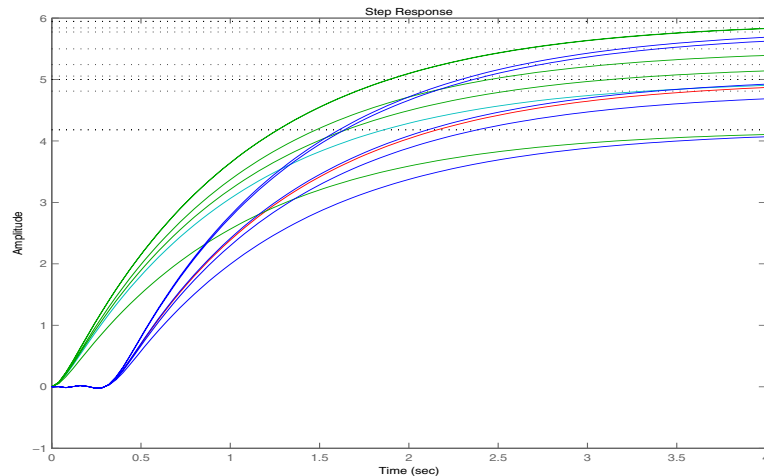



## Uncertain frd

Uncertain frequency responses (`ufrd`) arise naturally when computing the frequency response of an uncertain state-space (`uss`). They also arise when frequency response data (in an `frd` object) is combined (added, multiplied, concatenated, etc.) to an uncertain matrix (`umat`).

### Creating Uncertain Frequency Response Objects

The most common manner in which a `ufrd` arises is taking the frequency response of a `uss`. The natural command that would do this is `frd` (an overloaded version in the `@uss` directory).

Reconstruct `sys`, if necessary.

```
p1 = ureal('p1',10,'pe',50);
p2 = ureal('p2',3,'plusm',[-.5 1.2]);
p3 = ureal('p3',0);
A = [-p1 p2;0 -p1];
B = [-p2;p2+p3];
C = [1 0;1 1-p3];
D = [0;0];
sys = ss(A,B,C,D)
USS: 2 States, 2 Outputs, 1 Input, Continuous System
p1: real, nominal = 10, variability = [-50 50]%, 2 occurrences
p2: real, nominal = 3, variability = [-0.5 1.2], 2 occurrences
p3: real, nominal = 0, variability = [-1 1], 2 occurrences
```

Compute the uncertain frequency response of the uncertain system. Use the `frd` command, along with a frequency grid containing 100 points. The result is an uncertain frequency response data object, referred to as a `ufrd`.

```
sysg = frd(sys,logspace(-2,2,100))
UFRD: 2 Outputs, 1 Input, Continuous System, 100 Frequency
points
p1: real, nominal = 10, variability = [-50 50]%, 2 occurrences
p2: real, nominal = 3, variability = [-0.5 1.2], 2 occurrences
p3: real, nominal = 0, variability = [-1 1], 2 occurrences
```

### Properties of `ufrd` objects

View the properties with the `get` command.

```
get(sysg)
    Frequency: [100x1 double]
    ResponseData: [2x1x100 umat]
        Units: 'rad/s'
        Ts: 0
    InputName: {' '}
    OutputName: {2x1 cell}
    InputGroup: [1x1 struct]
    OutputGroup: [1x1 struct]
    NominalValue: [2x1 frd]
    Uncertainty: [1x1 atomlist]
        Notes: {}
    UserData: []
    Version: 4
```

The properties `ResponseData` and `Frequency` behave in exactly the same manner as Control System Toolbox `frd` objects, except that `ResponseData` is a `umat`. The properties `InputName`, `OutputName`, `InputGroup` and `OutputGroup` behave in exactly the same manner as all of the Control System Toolbox system objects (`ss`, `zpk`, `tf`, and `frd`).

The `NominalValue` is a Control System Toolbox `frd` object, and hence all methods for `frd` objects are available. For instance, plot the Bode response of the nominal system.

```
bode(sysg.nom)
```

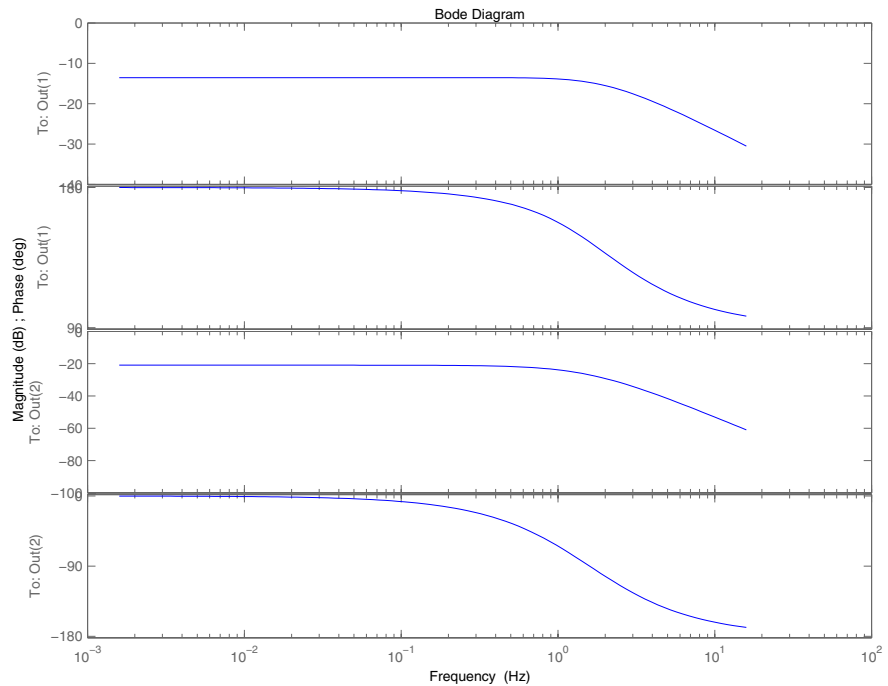

Just as with the `umat` and `uss` classes, the `Uncertainty` property is an `atomlist` object, acting as a gateway to the uncertain atoms. Direct access to the atoms is facilitated through `Uncertainty`. Change the nominal value of the uncertain element named 'p1' within `sysg` to 14, and replot the Bode plot of the (new) nominal system.

```
sysg.unc.p1.nom = 14
```

```
UFRD: 2 Outputs, 1 Input, Continuous System, 100 Frequency  
points
```

```
p1: real, nominal = 14, variability = [-50 50]%, 2 occurrences
```

```
p2: real, nominal = 3, variability = [-0.5 1.2], 2 occurrences
```

```
p3: real, nominal = 0, variability = [-1 1], 2 occurrences
```

## Interpreting Uncertainty in Discrete Time

This issue is described in the section “Interpreting Uncertainty in Discrete Time” on page 6-30.

## Lifting an frd to a ufrd

A not-uncertain frequency response object may be interpreted as an uncertain frequency response object that has no dependence on uncertain atoms. Use the `ufrd` command to “lift” an `frd` object to the `ufrd` class.

```
sys = rss(3,2,1);  
sysg = frd(sys,logspace(-2,2,100));  
usysg = ufrd(sysg)  
UFRD: 2 Outputs, 1 Input, Continuous System, 100 Frequency  
points
```

Arrays of `frd` objects can also be lifted. See the section “Array Management for Uncertain Objects” on page 6-49 for more information.

## Handling Delays in ufrd

This is identical to handling delays in USS, as described in the section “Handling Delays in `uss`” on page 6-31.

## Basic Control System Toolbox Interconnections

All of the basic system interconnections defined in the Control System Toolbox

- `append`
- `blkdiag`
- `series`
- `parallel`
- `feedback`
- `lft`
- `star`
- `starp`

work with uncertain objects as well. Uncertain objects may be combined with certain objects, resulting in an uncertain object.

## Simplifying Representation of Uncertain Objects

A minimal realization of the transfer function matrix

$$H(s) = \begin{bmatrix} \frac{2}{s+1} & \frac{4}{s+1} \\ \frac{3}{s+1} & \frac{6}{s+1} \end{bmatrix}$$

has only 1 state, obvious from the decomposition

$$H(s) = \begin{bmatrix} 2 \\ 3 \end{bmatrix} \frac{1}{s+1} \begin{bmatrix} 1 & 2 \end{bmatrix}.$$

However, a “natural” construction, formed by

```

sys11 = ss(tf(2,[1 1]));
sys12 = ss(tf(4,[1 1]));
sys21 = ss(tf(3,[1 1]));
sys22 = ss(tf(6,[1 1]));
sys = [sys11 sys12;sys21 sys22]
a =
      x1  x2  x3  x4
x1  -1   0   0   0
x2   0  -1   0   0
x3   0   0  -1   0
x4   0   0   0  -1
b =
      u1  u2
x1   2   0
x2   0   2
x3   2   0
x4  0  2
c =
      x1  x2  x3  x4
y1   1   2   0   0
y2   0   0  1.5  3
d =

```

$$\begin{array}{ccc} & u1 & u2 \\ y1 & 0 & 0 \\ y2 & 0 & 0 \end{array}$$

Continuous-time model.

has 4 states, and is nonminimal.

In the same manner, the internal representation of uncertain objects built up from uncertain atoms can become nonminimal, depending on the sequence of operations in their construction. The command `simplify` employs ad-hoc simplification and reduction schemes to reduce the complexity of the representation of uncertain objects. There are three levels of simplification: `off`, `basic` and `full`. Each uncertain atom has an `AutoSimplify` property whose value is one of the strings `'off'`, `'basic'` or `'full'`. The default value is `'basic'`.

After (nearly) every operation, the command `simplify` is automatically run on the uncertain object, cycling through all of the uncertain atoms, and attempting to simplify (without error) the representation of the effect of that uncertain object. The `AutoSimplify` property of each atom dictates the types of computations that are performed. In the `'off'` case, no simplification is even attempted. In `'basic'`, fairly simple schemes to detect and eliminate nonminimal representations are used. Finally, in `'full'`, numerical based methods similar to truncated balanced realizations are used, with a very tight tolerance to minimize error.

## Effect of AutoSimplify Property

Create an uncertain real parameter, view the `AutoSimplify` property of `a`, and then create a 1-by-2 `umat`, both of whose entries involve the uncertain parameter.

```
a = ureal('a',4);
a.AutoSimplify
ans =
basic
m1 = [a+4 6*a]
UMAT: 1 Rows, 2 Columns
a: real, nominal = 4, variability = [-1 1], 1 occurrence
```

Note that although the uncertain real parameter  $a$  appears in both (two) entries of the matrix, the resulting uncertain matrix  $m1$  only depends on “1 occurrence” of  $a$ .

Set the AutoSimplify property of  $a$  to 'off' (from 'basic'). Recreate the 1-by-2 umat. Now note that the resulting uncertain matrix  $m2$  depends on “2 occurrences” of  $a$ .

```
a.AutoSimplify = 'off';  
m2 = [a+4 6*a]  
UMAT: 1 Rows, 2 Columns  
a: real, nominal = 4, variability = [-1 1], 2 occurrences
```

The 'basic' level of autosimplification often detects (and simplifies) duplication created by linear terms in the various entries. Higher order (quadratic, bilinear, etc.) duplication is often not detected by the 'basic' autosimplify level.

For example, reset the AutoSimplify property of  $a$  to 'basic' (from 'off'). Create an uncertain real parameter, and a 1-by-2 umat, both of whose entries involve the square of the uncertain parameter.

```
a.AutoSimplify = 'basic';  
m3 = [a*(a+4) 6*a*a]  
UMAT: 1 Rows, 2 Columns  
a: real, nominal = 4, variability = [-1 1], 4 occurrences
```

Note that the resulting uncertain matrix  $m3$  depends on “4 occurrences” of  $a$ .

Set the AutoSimplify property of  $a$  to 'full' (from 'basic'). Recreate the 1-by-2 umat. Now note that the resulting uncertain matrix  $m4$  depends on “2 occurrences” of  $a$ .

```
a.AutoSimplify = 'full';  
m4 = [a*(a+4) 6*a*a]  
UMAT: 1 Rows, 2 Columns  
a: real, nominal = 4, variability = [-1 1], 2 occurrences
```

Although  $m4$  has a less complex representation (2 occurrences of  $a$  rather than 4 as in  $m3$ ), some numerical variations are seen when both uncertain objects are evaluated at (say) 0.

```
usubs(m3, 'a', 0)  
ans =
```



```

      0      0
usubs(m4, 'a', 0)
ans =
      1.0e-015 *
      -0.4441      0

```

Small numerical differences are also noted at other evaluation points. The example below shows the differences encountered evaluating at a equal to 1.

```

usubs(m3, 'a', 1)
ans =
      5      6
usubs(m4, 'a', 1)
ans =
      5.0000      6.0000

```

## Direct Use of simplify

The `simplify` command can be used to override the `AutoSimplify` property of all uncertain element. The first input to the `simplify` command is an uncertain object. The second input is the desired reduction technique, which can either `'basic'` or `'full'`.

Again create an uncertain real parameter, and a 1-by-2 `umat`, both of whose entries involve the square of the uncertain parameter. Set the `AutoSimplify` property of `a` to `'basic'`.

```

a.AutoSimplify = 'basic';
m3 = [a*(a+4) 6*a*a]
UMAT: 1 Rows, 2 Columns
a: real, nominal = 4, variability = [-1 1], 4 occurrences

```

Note that the resulting uncertain matrix `m3` depends on “4 occurrences” of `a`.

The `simplify` command can be used to perform a `'full'` reduction on the resulting `umat`.

```

m4 = simplify(m3, 'full')
UMAT: 1 Rows, 2 Columns
a: real, nominal = 4, variability = [-1 1], 2 occurrences

```

The resulting uncertain matrix `m4` depends on only “2 occurrences” of `a` after the reduction.

## Sampling Uncertain Objects

The command `usample` is used to randomly sample an uncertain object, giving a not-uncertain instance of the uncertain object.

### Generating One Sample

If `A` is an uncertain object, then `usample(A)` generates a single sample of `A`.

For example, a sample of a `ureal` is a scalar double.

```
A = ureal('A',6);
B = usample(A)
B =
    5.7298
```

Create a 1-by-3 `umat` with `A` and an uncertain complex parameter `C`. A single sample of this `umat` is a 1-by-3 double.

```
C = ucomplex('C',2+6j);
M = [A C A*A];
usample(M)
ans =
    5.9785          1.4375 + 6.0290i    35.7428
```

### Generating Many Samples

If `A` is an uncertain object, then `usample(A,N)` generates `N` samples of `A`.

For example, 20 samples of a `ureal` gives a 1-by-1-20 double array.

```
B = usample(A,20);
size(B)
ans =
     1     1    20
```

Similarly, 30 samples of the 1-by-3 `umat` `M` yields a 1-by-3-by-30 array.

```
size(usample(M,30))
ans =
     1     3    30
```

See the section “Creating Arrays With `usample`” on page 6-53 for more information about sampling uncertain objects.

## Sampling ultidyn Atoms

When sampling a `ultidyn` atom (or an uncertain object that contains a `ultidyn` atom in its Uncertainty gateway) the result is always a state-space (`ss`) object. The property `SampleStateDim` of the `ultidyn` class determines the state dimension of the samples.

Create a 1-by-1, gain bounded `ultidyn` object, with gain-bound 3. Verify that the default state dimension for samples is 1.

```
del = ultidyn('del',[1 1],'Bound',3);
del.SampleStateDim
ans =
    1
```

Sample the uncertain atom at 30 points. Verify that this creates a 30-by-1 `ss` array of 1-input, 1-output, 1-state systems.

```
delS = usample(del,30);
size(delS)
30x1 array of state-space models
Each model has 1 output, 1 input, and 1 state.
```

Plot the Nyquist plot of these samples and add a disk of radius 3. Note that the gain bound is satisfied and that the Nyquist plots are all circles, indicative of 1st order systems.

```
nyquist(delS)
hold on;
theta = linspace(-pi,pi);
plot(del.Bound*exp(sqrt(-1)*theta),'r');
hold off;
```

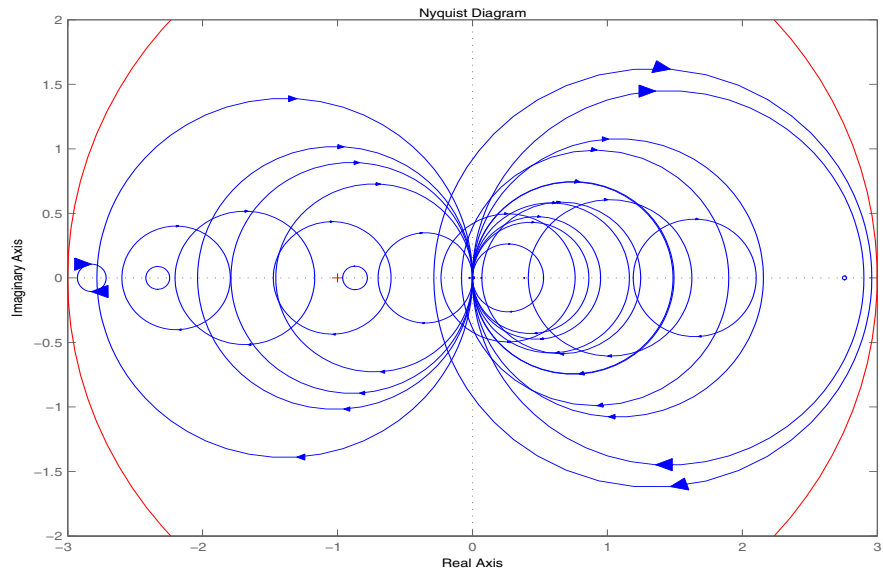

Change the `SampleStateDim` to 4, and repeat entire procedure. The Nyquist plots satisfy the gain bound and as expected are more complex than the circles found in the 1st-order sampling.

```
del.SampleStateDim = 4;
delS = usample(del,30);
nyquist(delS)
hold on;
theta = linspace(-pi,pi);
plot(del.Bound*exp(sqrt(-1)*theta),'r');
hold off;
```

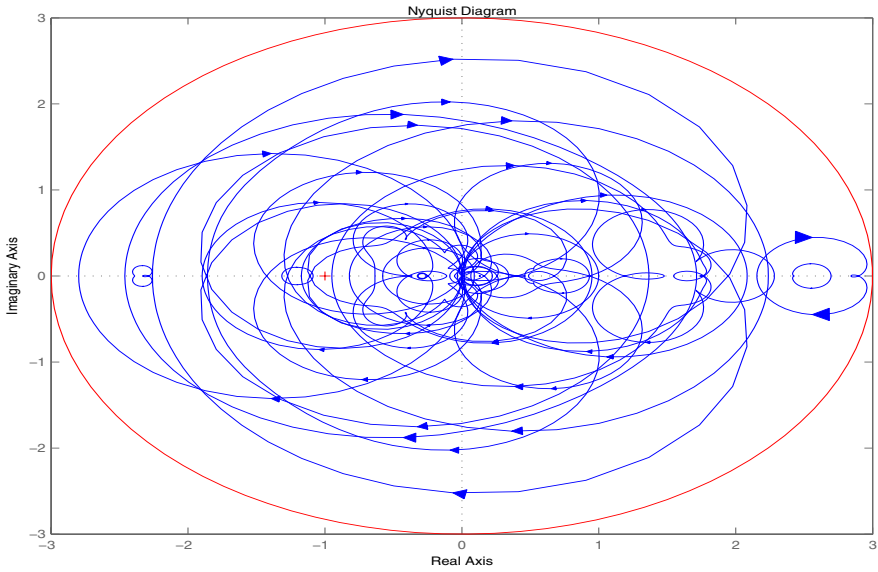

## Substitution by usubs

If an uncertain object (`umat`, `uss`, `ufrd`) has many uncertain parameters, it is often necessary to freeze some, but not all, of the uncertain parameters to specific values. The `usubs` command accomplishes this, and also allows more complicated substitutions for an atom.

`usubs` accepts a list of atom names, and respective values to substitute for them. You can create 3 uncertain real parameters and use them to create a 2-by-2 uncertain matrix `A`.

```
delta = ureal('delta',2);
eta = ureal('eta',6);
rho = ureal('rho',-1);
A = [3+delta+eta delta/eta;7+rho rho+delta*eta]
UMAT: 2 Rows, 2 Columns
delta: real, nominal = 2, variability = [-1 1], 2 occurrences
eta: real, nominal = 6, variability = [-1 1], 3 occurrences
rho: real, nominal = -1, variability = [-1 1], 1 occurrence
```

Use `usubs` to substitute the uncertain element named `delta` in `A` with the value 2.3, leaving all other uncertain atoms intact. Note that the result, `B`, is an uncertain matrix with dependence only on `eta` and `rho`.

```
B = usubs(A,'delta',2.3)
UMAT: 2 Rows, 2 Columns
eta: real, nominal = 6, variability = [-1 1], 3 occurrences
rho: real, nominal = -1, variability = [-1 1], 1 occurrence
```

To set multiple atoms, list individually, or in cells. The following are the same

```
B1 = usubs(A,'delta',2.3,'eta',A.Uncertainty.rho);
B2 = usubs(A,{'delta','eta'},{2.3;A.Uncertainty.rho});
```

In each case, `delta` is replaced by 2.3, and `eta` is replaced by `A.Uncertainty.rho`.

If it makes sense, a single replacement value can be used to replace multiple atoms. So

```
B3 = usubs(A,{'delta','eta'},2.3);
```

replaces both the atoms `delta` and `eta` with the real number 2.3. Any superfluous substitution requests are ignored. Hence

```
B4 = usubs(A, 'fred', 5);
```

is the same as A, and

```
B5 = usubs(A, {'delta'; 'eta'}, 2.3, {'fred' 'gamma'}, 0);
```

is the same as B3.

## Specifying the Substitution with Structures

An alternative syntax for usubs is to specify the substituted values in a structure, whose fieldnames are the names of the atoms being substituted with values.

Create a structure NV with 2 fields, delta and eta. Set the values of these fields to be the desired values. Then perform the substitution with usubs.

```
NV.delta = 2.3;
NV.eta = A.Uncertainty.rho;
B6 = usubs(A, NV);
```

Here, B6 is the same as B1 and B2 above. Again, any superfluous fields are ignored. Therefore, adding an additional field gamma to NV, and substituting does not alter the result.

```
NV.gamma = 0;
B7 = usubs(A, NV);
```

Here, B7 is the same as B6.

The commands wcgain, robuststab, and usample all return substitutable values in this structure format. See the section “Creating Arrays With usubs” on page 6-55 for more information.

## Nominal and Random Values

If the replacement value is the (partial and case-independent) string 'Nominal', then the listed atom are replaced with their nominal values. Therefore

```
B8 = usubs(A, fieldnames(A.Uncertainty), 'nom')
B8 =
    11.0000    0.3333
     6.0000    11.0000
```

```
B9 = A.NominalValue
B9 =
    11.0000    0.3333
     6.0000    11.0000
```

are the same. It is possible to only set some of the atoms to NominalValues, and would be the typical use of `usubs` with the 'nominal' argument.

Within A, set eta to its nominal value, delta to a random value (within its range) and rho to a specific value, say 6.5

```
B10 = usubs(A, 'eta', 'nom', 'delta', 'rand', 'rho', 6.5)
B10 =
    10.5183    0.2531
    13.5000    15.6100
```

Unfortunately, the 'Nominal' and 'Random' specifiers may not be used in the structure format. However, explicitly setting a field of the structure to an atom's nominal value, and then following (or preceding) the call to `usubs` with a call to `usample` (to generate the random samples) is acceptable, and achieves the same effect.



## Array Management for Uncertain Objects

All of the uncertain system classes (`uss`, `ufrd`) may be multidimensional arrays. This is intended to provide the same functionality as the LTI-arrays of the Control System Toolbox. The command `size` returns a row vector with the sizes of all dimensions.

The first two dimensions correspond to the outputs and inputs of the system. Any dimensions beyond are referred to as the *array dimensions*. Hence, if `szM = size(M)`, then `szM(3:end)` are sizes of the array dimensions of `M`.

For these types of objects, it is clear that the first two dimensions (system output and input) are interpreted differently from the 3rd, 4th, 5th and higher dimensions (which often model parametrized variability in the system input/output behavior).

`umat` objects are treated in the same manner. The first two dimensions are the rows and columns of the uncertain matrix. Any dimensions beyond are the *array dimensions*.

### Referencing Arrays

Suppose `M` is a `umat`, `uss` or `ufrd`, and that `Yidx` and `Uidx` are vectors of integers. Then

$$M(Yidx, Uidx)$$

selects the outputs (rows) referred to by `Yidx` and the inputs (columns) referred to by `Uidx`, preserving all of the array dimensions. For example, if `size(M)` equals `[4 5 3 6 7]`, then (for example) the size of `M([4 2], [1 2 4])` is `[2 3 3 6 7]`.

If `size(M,1)==1` or `size(M,2)==1`, then single indexing on the inputs or outputs (rows or columns) is allowed. If `Sidx` is a vector of integers, then `M(Sidx)` selects the corresponding elements. All array dimensions are preserved.

If there are `K` array dimensions, and `idx1`, `idx2`, ..., `idxK` are vectors of integers, then

$$G = M(Yidx, Uidx, idx1, idx2, \dots, idxK)$$

selects the outputs and inputs referred to by `Yidx` and `Uidx`, respectively, and selects from each array dimension the “slices” referred to by the `idx1`,

`idx2, ..., idxK` index vectors. Consequently, `size(G,1)` equals `length(Yidx)`, `size(G,2)` equals `length(Uidx)`, `size(G,3)` equals `length(idx1)`, `size(G,4)` equals `length(idx2)`, and `size(G,K+2)` equals `length(idxK)`.

If `M` has `K` array dimensions, and less than `K` index vectors are used in doing the array referencing, then the MATLAB convention for single indexing is followed. For instance, suppose `size(M)` equals `[3 4 6 5 7 4]`. The expression

```
G = M([1 3],[1 4],[2 3 4],[5 3 1],[8 10 12 2 4 20 18])
```

is valid. The result has `size(G)` equals `[2 2 3 3 7]`. The last index vector `[8 10 12 2 4 20 18]` is used to reference into the 7-by-4 array, preserving the order dictated by MATLAB single indexing (e.g., the 10th element of a 7-by-4 array is the element in the (3,2) position in the array).

Note that if `M` has either one output (row) or one input (column), and `M` has array dimensions, then it is not allowable to combine single indexing in the output/input dimensions along with indexing in the array dimensions. This will result in an ambiguity in how to interpret the second index vector in the expression (i.e., “does it correspond to the input/output reference, or does it correspond to the first array dimension?”).

## Creating Arrays with `stack`, `cat`

An easy manner to create an array is with `stack`. Create a [4-by-1] umat array by stacking four 1-by-3 umat objects with the `stack` command. The first argument of `stack` specifies in which array dimension the stacking occurs. In the example below, the stacking is done in the 1st array dimension, hence the result is a 1-by-3-by-4-by-1 umat, referred to as a 4-by-1 umat array.

```
a = ureal('a',4);
b = ureal('b',2);
M = stack(1,[a b 1],[-a -b 4+a],[4 5 6],[a 0 0])
UMAT: 1 Rows, 3 Columns [array, 4 x 1]
    a: real, nominal = 4, variability = [-1 1], 1 occurrence
    b: real, nominal = 2, variability = [-1 1], 1 occurrence
size(M)
ans =
     1     3     4
arraysize(M)
```

```
ans =
     4     1
```

Check that result is valid. Use referencing to access parts of the [4-by-1] umat array and compare to the expected values. The first 4 examples should all be arrays full of 0 (zeros). The last two should be the value 5, and the uncertain real parameter a, respectively.

```
simplify(M(:,:,1) - [a b 1])
ans =
     0     0     0
simplify(M(:,:,2) - [-a -b 4+a])
ans =
     0     0     0
simplify(M(:,:,3) - [4 5 6])
ans =
     0     0     0
simplify(M(:,:,4) - [a 0 0])
ans =
     0     0     0
simplify(M(1,2,3)) % should be 5
ans =
     5
simplify(M(1,3,2)-4)
Uncertain Real Parameter: Name a, NominalValue 4, variability =
[-1 1]
```

You can create a random 1-by-3-by-4 double matrix and stack this with M along the second array dimension, creating a 1-by-3-by-4-by-2 umat.

```
N = randn(1,3,4);
M2 = stack(2,M,N);
size(M2)
ans =
     1     3     4     2
arraysize(M2)
ans =
     4     2
```

As expected, both M and N can be recovered from M2.

```
d1 = simplify(M2(:,:,:,1)-M);
```

```
d2 = simplify(M2(:,:,2)-N);
[max(abs(d1(:))) max(abs(d2(:)))]
ans =
     0     0
```

It is also possible to stack M and N along the 1st array dimension, creating a 1-by-3-by-8-by-1 umat.

```
M3 = stack(1,M,N);
size(M3)
ans =
     1     3     8
arraysize(M3)
ans =
     8     1
```

As expected, both M and N can be recovered from M3.

```
d3 = simplify(M3(:,:,1:4)-M);
d4 = simplify(M3(:,:,5:8)-N);
[max(abs(d3(:))) max(abs(d4(:)))]
ans =
     0     0
```

## Creating Arrays by Assignment

Arrays can be created by direct assignment. As with other MATLAB classes, there is no need to preallocate the variable first. Simply assign elements – all resizing is performed automatically.

For instance, an equivalent construction to

```
a = ureal('a',4);
b = ureal('b',2);
M = stack(1,[a b 1],[-a -b 4+a],[4 5 6],[a 0 0]);
is
Mequiv(1,1,1) = a;
Mequiv(1,2,1) = b;
Mequiv(1,3,1) = 1;
Mequiv(1,:,4) = [a 0 0];
Mequiv(1,:,2:3) = stack(1,[-a -b 4+a],[4 5 6]);
```

The easiest manner for you to verify that the results are the same is to subtract and simplify,

```
d5 = simplify(M-Mequiv);
max(abs(d5(:)))
ans =
    0
```

## Binary Operations with Arrays

Most operations simply cycle through the array dimensions, doing pointwise operations. Assume  $A$  and  $B$  are `umat` (or `uss`, or `ufrd`) arrays with identical array dimensions (slot 3 and beyond). The operation  $C = \text{fcn}(A,B)$  is equivalent to looping on  $k_1, k_2, \dots$ , setting

$$C(:, :, k_1, k_2, \dots) = \text{fcn}(A(:, :, k_1, k_2, \dots), B(:, :, k_1, k_2, \dots))$$

The result  $C$  has the same array dimensions as  $A$  and  $B$ . The user is required to manage the extra dimensions (i.e., keep track of what they mean).

Methods such as `permute`, `squeeze` and `reshape` are included to facilitate this management.

In general, any binary operation requires that the extra-dimensions are compatible. The `umat`, `uss` and `ufrd` objects allow for slightly more flexible interpretation of this. For illustrative purposes, consider a binary operation involving variables  $A$  and  $B$ . Suppose the array dimensions of  $A$  are

$$n_1 \times \dots \times n_{l_A} \quad \text{and that the array dimensions of } B \text{ are } m_1 \times \dots \times m_{l_B}.$$

By MATLAB convention, the infinite number of singleton (i.e., 1) trailing dimensions are not listed. The compatibility of the extra dimensions is determined by the following rule: If  $l_A = l_B$ , then pad the shorter dimension list with trailing 1's. Now compare the extra dimensions: In the  $k$ -th dimension, it must be that one of 3 conditions hold:  $n_k = m_k$ , or  $n_k = 1$  or  $m_k = 1$ . In other words, non-singleton dimensions must exactly match (so that the pointwise operation can be executed), and singleton dimensions match with anything, implicitly through a `repmat`.

## Creating Arrays With `usample`

You can generate an array by sampling an uncertain object in some of the uncertain elements. Using the `ureal` objects `a` and `b` from above, create a 2-by-3 `umat`.

```
M = [a b;b*b a/b;1-b 1+a*b]
UMAT: 3 Rows, 2 Columns
  a: real, nominal = 4, variability = [-1 1], 3 occurrences
  b: real, nominal = 2, variability = [-1 1], 6 occurrences
size(M)
ans =
     3     2
```

Sample (at 20 random points within its range) the uncertain real parameter  $b$  in the matrix  $M$ . This results in a 3-by-2-by-20 `umat`, with only one uncertain element,  $a$ . The uncertain element  $b$  of  $M$  has been “sampled out”, leaving a new array dimension in its place.

```
[Ms,bvalues] = usample(M,'b',20);
Ms
UMAT: 3 Rows, 2 Columns [array, 20 x 1]
  a: real, nominal = 4, variability = [-1 1], 2 occurrences
size(Ms)
ans =
     3     2    20
```

Continue sampling (at 15 random points within its range) the uncertain real parameter  $a$  in the matrix  $Ms$ . This results in a 3-by-2-by-20-by-15 double.

```
[Mss,avalues] = usample(Ms,'a',15);
size(Mss)
ans =
     3     2    20    15
class(Mss)
ans =
double
```

The above 2-step sequence can be performed in 1 step,

```
[Mss,values] = usample(M,'b',20,'a',15);
class(Mss)
ans =
double
```

In this case, `values` is a 20-by-15 struct array, with 2 fields  $b$  and  $a$ , whose values are the values used in the random sampling. It follows that `usubs(M,values)` is the same as `Mss`.

Rather than sampling the each variable (a and b) independently, generating a 20-by-15 grid in a 2-dimensional space, the two-dimensional space can be sampled. Sample the 2-dimensional space with 800 points,

```
[Ms,values] = usample(M,{'a' 'b'},800);
size(Ms)
ans =
     3     2    800
size(values)
ans =
    800     1
```

## Creating Arrays With usubs

Suppose that Values is a struct array with the following properties: the dimensions of Values “match” the array dimensions of M, as described in the section “Creating Arrays With usample” on page 6-53; the field names of Values are some (or all) of the names of the uncertain elements of M; and the dimensions of the contents of the fields within Values match the sizes of the uncertain elements within M. Then usubs(M,Values) will substitute the uncertain elements in M with the contents found in the respective fields of Values.

You can create a 3-by-2 uncertain matrix using 2 uncertain real parameters.

```
a = ureal('a',4);
b = ureal('b',2);
M = [a b;b*b a/b;1-b 1+a*b];
```

Create a 5-by-1 struct array with fieldname a. Make its values random scalars. Create a 1-by-4 struct array with fieldname b.

```
Avalue = struct('a',num2cell(rand(5,1)));
Bvalue = struct('b',num2cell(rand(1,4)));
```

Substitute the uncertain real parameter a in M with the values in Avalue, yielding ma. Similarly substitute the uncertain real parameter b in M with the values in Bvalue, yielding mb.

```
ma = usubs(M,Avalue)
UMAT: 3 Rows, 2 Columns [array, 5 x 1]
     b: real, nominal = 2, variability = [-1 1], 6 occurrences
mb = usubs(M,Bvalue)
```

```
UMAT: 3 Rows, 2 Columns [array, 1 x 4]
a: real, nominal = 4, variability = [-1 1], 2 occurrences
```

Continue, substituting the uncertain real parameter `b` in `ma` with the values in `Bvalue`, yielding `mab`. Do the analogous operation for `mb`, yielding `mba`. Subtract, and note that the difference is 0, as expected.

```
mab = usubs(ma,Bvalue);
mba = usubs(mb,Avalue);
thediff = mab-mba;
max(abs(thediff(:)))
ans =
4.4409e-016
```

## Creating Arrays with `gridreal`

The command `gridreal` enables uniform sampling of specified uncertain real parameters within an uncertain object. It is a specialized case of `usubs`.

`gridreal` removes a specified uncertain real parameter and adds an array dimension (to the end of the existing array dimensions). The new array dimension represents the uniform samples of the uncertain object along the specified uncertain real parameter's range.

Create a 2-by-2 uncertain matrix with 3 uncertain real parameters.

```
a = ureal('a',3,'Range',[2.5 4]);
b = ureal('b',4,'Percentage',15);
c = ureal('c',-2,'Plusminus',[-1 .3]);
M = [a b;b c]
UMAT: 2 Rows, 2 Columns
a: real, nominal = 3, range = [2.5 4], 1 occurrence
b: real, nominal = 4, variability = [-15 15]%, 2 occurrences
c: real, nominal = -2, variability = [-1 0.3], 1 occurrence
```

Grid the uncertain real parameter `b` in `M` with 100 points. The result is a `umat` array, with dependence on uncertain real parameters `a` and `c`.

```
Mgrid1 = gridreal(M,'b',100)
UMAT: 2 Rows, 2 Columns [array, 100 x 1]
a: real, nominal = 3, range = [2.5 4], 1 occurrence
c: real, nominal = -2, variability = [-1 0.3], 1 occurrence
```



Operating on the uncertain matrix  $M$ , grid the uncertain real parameter  $a$  with 20 points, the uncertain real parameter  $b$  with 12 points, and the uncertain real parameter  $c$  with 7 points. The result is a 2-by-2-by20-by-12-by7 double array.

```
Mgrid3 = gridreal(M, 'a',20, 'b',12, 'c',7);
size(Mgrid3)
ans =
     2     2    20    12     7
```

## Creating Arrays with repmat

The MATLAB command `repmat` is used to replicate and tile arrays. It works on the built-in objects of MATLAB, namely `double`, `char`, as well as the generalized container objects `cell` and `struct`. The identical functionality is provided for replicating and tiling uncertain elements (`ureal`, `ultidyn`, etc.) and `umat` objects.

You can create an uncertain real parameter, and replicate it in a 2-by-3 uncertain matrix. Compare to generating the same uncertain matrix through multiplication.

```
a = ureal('a',5);
Amat = repmat(a,[2 3])
UMAT: 2 Rows, 3 Columns
   a: real, nominal = 5, variability = [-1 1], 1 occurrence
Amat2 = a*ones(2,3);
simplify(Amat-Amat2)
ans =
     0     0     0
     0     0     0
```

Create (as in section a) a [4-by-1] `umat` array by stacking four 1-by-3 `umat` objects with the `stack` command. Use `repmat` to tile this 1-by-3-by-4-by-1 `umat`, into a 2-by-3-by-8-by-5 `umat`.

```
a = ureal('a',4);
b = ureal('b',2);
M = stack(1,[a b 1],[-a -b 4+a],[4 5 6],[a 0 0]);
size(M)
ans =
     1     3     4
```

```
Mtiled = repmat(M,[2 1 2 5])
UMAT: 2 Rows, 3 Columns [array, 8 x 5]
  a: real, nominal = 4, variability = [-1 1], 1 occurrence
  b: real, nominal = 2, variability = [-1 1], 1 occurrence
Verify the equality of M and a few certain tiles of Mtiled.
d1 = simplify(M-Mtiled(2,:,5:8,3));
d2 = simplify(M-Mtiled(1,:,1:4,2));
d3 = simplify(M-Mtiled(2,:,1:4,5));
[max(abs(d1(:))) max(abs(d2(:))) max(abs(d3(:)))]
ans =
     0     0     0
```

Note that `repmat` never increases the complexity of the representation of an uncertain object. The number of occurrences of each uncertain element remains the same, regardless of the extent of the replication and tiling.

## Creating Arrays with `repsys`

Replicating and tiling uncertain state-space systems (`uss`, and uncertain frequency response data (`ufrd`) is done with `repsys`. The syntax and behavior are the same as the manner in which `repmat` is used to replicate and tile matrices. The syntax and behavior of `repsys` for `uss` and `ufrd` objects are the same as the traditional `repsys` which operates on `ss` and `frd` object. Just as in those cases, the uncertain version of `repsys` also allows for diagonal tiling.

## Using `permute` and `ipermute`

The commands `permute` and `ipermute` are generalizations of `transpose`, which exchanges the rows and columns of a two-dimensional matrix.

`permute(A,ORDER)` rearranges the dimensions of `A` so that they are in the order specified by the vector `ORDER`. The array produced has the same values of `A` but the order of the subscripts needed to access any particular element are rearranged as specified by `ORDER`. The elements of `ORDER` must be a rearrangement of the numbers from 1 to `N`.

All of the uncertain objects are essentially 2-dimensional (output and input) operators with array dependence. This means that the first 2 dimensions are treated differently from dimensions 3 and beyond. It is not permissible to `permute` across these groups.

For `uss` and `ufrd`, the restriction is built into the syntax. The elements of the `ORDER` vector **only** refer to array dimensions. Therefore, there is no possibility of permute across these dimensions. In you need to permute the first two dimensions, use the command `transpose` instead.

For `umat`, the restriction is enforced in the software. The elements of the `ORDER` vector refer to all dimensions. However, the first two elements of `ORDER` must be a rearrangement of the numbers 1 and 2. The remaining elements of `ORDER` must be a rearrangement of the numbers 3 through `N`. If either of those conditions fail, an error is generated. Hence, for `umat` arrays, either `permute` or `transpose` can be used to effect the transpose operation.

## Decomposing Uncertain Objects (for Advanced Users)

Each uncertain object (`umat`, `uss`, `ufrd`) is a generalized feedback connection (`lft`) of a not-uncertain object (e.g., `double`, `ss`, `frd`) with a diagonal augmentation of uncertain atoms (`ureal`, `ultidyn`, `ucomplex`, `ucomplexm`, `udyn`). In robust control jargon, if the uncertain elements are normalized, this decomposition is often called “the  $M/\Delta$  form.”

The purpose of the uncertain objects (`ureal`, `ultidyn`, `umat`, `uss`, etc.) is to hide this underlying decomposition, and allow the user to focus on modeling and analyzing uncertain systems, rather than the details of correctly propagating the  $M/\Delta$  representation in manipulations. Nevertheless, advanced users may want access to the familiar  $M/\Delta$  form. The command `lftdata` accomplishes this decomposition.

Since `ureal`, `ucomplex` and `ucomplexm` do not have their `NominalValue` necessarily at zero, and in the case of `ureal` objects, are not symmetric about the `NominalValue`, some details are required in describing the decomposition.

### Normalizing Functions for Uncertain Atoms

Associated with each uncertain element is a normalizing function. The normalizing function maps the uncertain element into a normalized uncertain element.

If  $\rho$  is an uncertain real parameter, with range  $[L \ R]$  and nominal value  $N$ , then the normalizing function  $F$  is

$$F(\rho) = \frac{A + B\rho}{C + D\rho}$$

with the property that for all  $\rho$  satisfying  $L \leq \rho \leq R$ , it follows that  $-1 \leq F(\rho) \leq 1$ , moreover,  $F(L) = -1$ ,  $F(N) = 0$ , and  $F(R) = 1$ . It is left as an exercise for the user to work out the various values for  $A$ ,  $B$ ,  $C$  and  $D$  as functions of the nominal value and range.

If  $E$  is an uncertain gain-bounded, linear, time-invariant dynamic uncertainty, with gain-bound  $\beta$ , then the normalizing function  $F$  is

$$F(E) = \frac{1}{\beta} E.$$

If  $E$  is an uncertain positive-real, linear, time-invariant dynamic uncertainty, with positivity bound  $\beta$ , then the normalizing function  $F$  is

$$F(E) = \left[ I - \alpha \left( E - \frac{\beta}{2} I \right) \right] \left[ I + \alpha \left( E - \frac{\beta}{2} I \right) \right]^{-1}$$

where  $\alpha=2|\beta|+1$ .

The normalizing function for an uncertain complex parameter  $\xi$ , with nominal value  $C$  and radius  $\gamma$  is

$$F(\xi) = \frac{1}{\gamma}(\xi - C)$$

The normalizing function for uncertain complex matrices  $H$ , with nominal value  $N$  and weights  $W_L$  and  $W_R$  is

$$F(H) = W_L^{-1}(H - N)W_R^{-1}$$

In each case, as the uncertain atom varies over its range, the absolute value of the normalizing function (or norm, in the matrix case) varies from 0 and 1.

## Properties of the Decomposition

Take an uncertain object  $A$ , dependent on uncertain real parameters  $\rho_1, \dots, \rho_N$ , uncertain complex parameters  $\xi_1, \dots, \xi_K$ , uncertain complex matrices  $H_1, \dots, H_B$ , uncertain gain-bounded linear, time-invariant dynamics  $E_1, \dots, E_D$ , and uncertain positive-real linear, time-invariant dynamics  $P_1, \dots, P_Q$ .

Write  $A(\rho, \xi, H, E, P)$  to indicate this dependence. Using `lftdata`,  $A$  can be decomposed into two separate pieces:  $M$  and  $\Delta(\rho, \xi, H, E, P)$  with the following properties

$M$  is certain (i.e., if  $A$  is `uss`, then  $M$  is `ss`; if  $A$  is `umat`, then  $M$  is `double`; if  $A$  is `ufrd`, then  $M$  is `frd`).

$\Delta$  is always a `umat`, depending on the same uncertain elements as  $A$ , with ranges, bounds, weights, etc., unaltered.

The form of  $\Delta$  is block diagonal, with elements made up of the normalizing functions acting on the individual uncertain elements.

$$\Delta(\rho, \xi, H, E, P) = \begin{bmatrix} F(\rho) & 0 & 0 & 0 & 0 \\ 0 & F(\xi) & 0 & 0 & 0 \\ 0 & 0 & F(H) & 0 & 0 \\ 0 & 0 & 0 & F(E) & 0 \\ 0 & 0 & 0 & 0 & F(P) \end{bmatrix}$$

$A(\rho, \xi, H, E, P)$  is given by a linear fractional transformation of  $M$  and  $\Delta(\rho, \xi, H, E, P)$ ,

$$A(\rho, \xi) = M_{22} + M_{21}\Delta(\rho, \xi, H, E, P)[I - M_{11}\Delta(\rho, \xi, H, E, P)]^{-1}M_{12}$$

The order of the normalized atoms making up  $A$  is not the simple order shown above. It is actually the same order as given by the command `fieldnames(M.Uncertainty)`. See the section “Advanced Syntax of `lftdata`” on page 6-64 for more information.

## Syntax of `lftdata`

The decomposition is carried out by the command `lftdata`.

You can create a 2-by-2 umat named  $A$  using 3 uncertain real parameters.

```
delta = ureal('delta',2);
eta = ureal('eta',6);
rho = ureal('rho',-1);
A = [3+delta+eta delta/eta;7+rho rho+delta*eta]
UMAT: 2 Rows, 2 Columns
delta: real, nominal = 2, variability = [-1 1], 2 occurrences
eta: real, nominal = 6, variability = [-1 1], 3 occurrences
rho: real, nominal = -1, variability = [-1 1], 1 occurrence
```

Note that  $A$  depends on 2 occurrences of  $\delta$ , 3 occurrences of  $\eta$  and 1 occurrence of  $\rho$ .

Decompose  $A$  into  $M$  and  $\Delta$ . Note that  $M$  is a double, and  $\Delta$  has the same uncertainty dependence as  $A$ .

```
[M,Delta] = lftdata(A)
M =
    0    0    0 -0.1667    0    0
1.0000  0.1667
    0    0    0    0  1.0000    0
0  6.0000
    0    0    0    0    0    0
1.0000    0
    0    0    0 -0.1667    0    0
0  0.1667
    0    0    0    0    0    0
0  1.0000
    0    0    0    0    0    0
1.0000  1.0000
    1.0000  0  1.0000 -0.3333    0    0
11.0000  0.3333
```

```

      0    1.0000      0      0    2.0000    1.0000
6.0000 11.0000

```

```
UMAT: 6 Rows, 6 Columns
```

```
delta: real, nominal = 2, variability = [-1 1], 2 occurrences
```

```
eta: real, nominal = 6, variability = [-1 1], 3 occurrences
```

```
rho: real, nominal = -1, variability = [-1 1], 1 occurrence
```

Sample Delta at 5 points. Things to note are: it is diagonal; the values range between -1 and 1; there are 3 independent values, and duplication of the entries is consistent with the dependence of Delta and A on the 3 uncertain real parameters.

```
usample(Delta,5)
```

```
ans(:,:,1) =
```

```

0.0224      0      0      0      0      0
      0    0.0224      0      0      0      0
      0      0   -0.1498      0      0      0
      0      0      0   -0.1498      0      0
      0      0      0      0   -0.1498      0
      0      0      0      0      0      0.9620

```

```
ans(:,:,2) =
```

```

0.8016      0      0      0      0      0
      0    0.8016      0      0      0      0
      0      0   -0.2106      0      0      0
      0      0      0   -0.2106      0      0
      0      0      0      0   -0.2106      0
      0      0      0      0      0   -0.4700

```

```
ans(:,:,3) =
```

```

0.1222      0      0      0      0      0
      0    0.1222      0      0      0      0
      0      0   -0.9328      0      0      0
      0      0      0   -0.9328      0      0
      0      0      0      0   -0.9328      0
      0      0      0      0      0   -0.2453

```

```
ans(:,:,4) =
```

```

-0.3433      0      0      0      0      0
      0   -0.3433      0      0      0      0
      0      0   -0.4898      0      0      0
      0      0      0   -0.4898      0      0
      0      0      0      0   -0.4898      0
      0      0      0      0      0   -0.3629

```

```
ans(:,:,5) =
    0.1409         0         0         0         0         0
         0    0.1409         0         0         0         0
         0         0   -0.3917         0         0         0
         0         0         0   -0.3917         0         0
         0         0         0         0   -0.3917         0
         0         0         0         0         0    0.5187
```

In fact, verify that the maximum gain of Delta is indeed 1.

```
maxnorm = wcnorm(Delta)
maxnorm =
    lbound: 1.0000
    ubound: 1.0004
```

Finally, verify that `lft(Delta,M)` is the same as `A`. Subtract (and use the 'full' option in `simplify`)

```
simplify(lft(Delta,M)-A,'full')
ans =
     0     0
     0     0
```

## Advanced Syntax of `lftdata`

Even for the advanced user, the variable `Delta` will actually not be that useful, as it is still a complex object. On the other hand, its internal structure is described completely using a 3rd argument.

```
[M,Delta,BlkStruct] = lftdata(A);
```

The rows of `BlkStruct` correspond to the uncertain atoms named in `fieldnames(A.Uncertainty)`. Note that the range/bound information about each uncertain atom is not included in `BlkStruct`.

```
BlkStruct
BlkStruct =
     1     1     2     1
     1     1     3     1
     1     1     1     1
fieldnames(A.Uncertainty)
ans =
    'delta'
```



'eta'  
'rho'

Together, these mean  $\Delta$  is a block diagonal augmentation of the normalized version of 3 uncertain atoms.

The first atom is named 'delta'. It is 1-by-1 (first two columns of `BlkStruct`; there are 2 copies diagonally augmented (3rd column of `BlkStruct`); and it is of type 1 (4th column of `BlkStruct`), which means ureal.

The second atom is named 'eta'. It is 1-by-1; there are 3 copies diagonally augmented; and it is of type 1.

The third atom is named 'rho'. It is 1-by-1; there 1 copy; and it is of type 1.

Other types include: `ultidyn` is type 2; `ucomplex` is type 3; `ucomplexm` is type 4; and `udyn` is type 5.

Hence, by manipulating `M` and `BlkStruct`, a power-user has direct access to all of the linear fractional transformation details, and can easily work at the level of the theorems and algorithms that underlie the methods.







# Generalized Robustness Analysis

---

Introduction to Generalized  
Robustness Analysis (p. 7-2)

Robust Stability Margin (p. 7-5)

Robust Performance Margin (p. 7-6)

Worst-Case Gain Measure (p. 7-7)

What is generalized robustness analysis?

A brief discussion of robust stability margins

The definition of robust performance margins

The maximum achievable gain over all uncertain system  
objects

## Introduction to Generalized Robustness Analysis

The performance of a nominally-stable uncertain system model will generally degrade for specific values of its uncertain elements. Moreover, the maximum possible degradation increases as the uncertain elements are allowed to further and further deviate from their nominal values.

The graph below shows the typical trade-off curve between allowable deviation of uncertain elements from their nominal values and the worst-case degradation in system performance. Here, system performance is characterized by system gain (e.g., peak magnitude on Bode plot). Interpreting the system as the relationship mapping disturbances/commands to errors, small system gains are desirable, and large gains are undesirable.

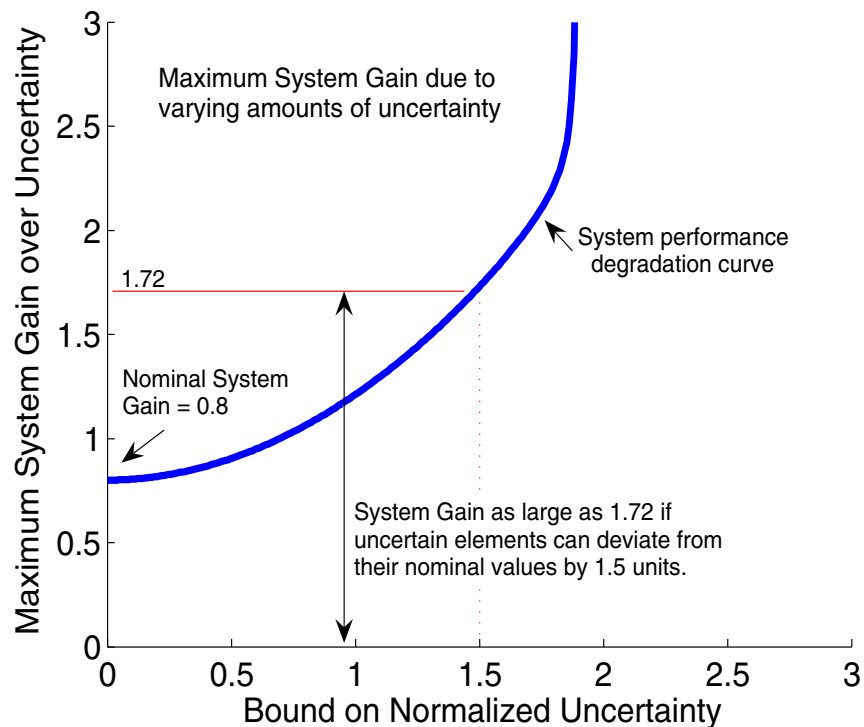

When all uncertain elements are set to their nominal values (i.e., zero deviation from their nominal values) the input/output gain of the system is its

nominal value. In the figure, the nominal system gain is about 0.8. As the uncertainties are allowed to deviate from nominal, the maximum (over the uncertain elements) system gain increases. The heavy blue line represents the maximum system gain due to uncertainty of various sizes (the horizontal axis), and is called the *system performance degradation curve*. It is monotonically increasing.

Determining specific attributes of the system performance degradation curve are referred to as robustness computations.

Generally, “robustness computations” refer to determining specific attributes of the system performance degradation curve. The commands `robuststab`, `robustperf` and `wcgain` all compute single scalar attributes of the system performance degradation curve.

Redraw the *system performance degradation curve* with 3 additional curves: a hyperbola defined by  $xy=1$ ; a vertical line drawn at the uncertainty bound = 1; and a vertical line tangent to the asymptotic behavior of the performance

degradation curve at large uncertainty bounds. These are used to define three robustness measures, explained next.

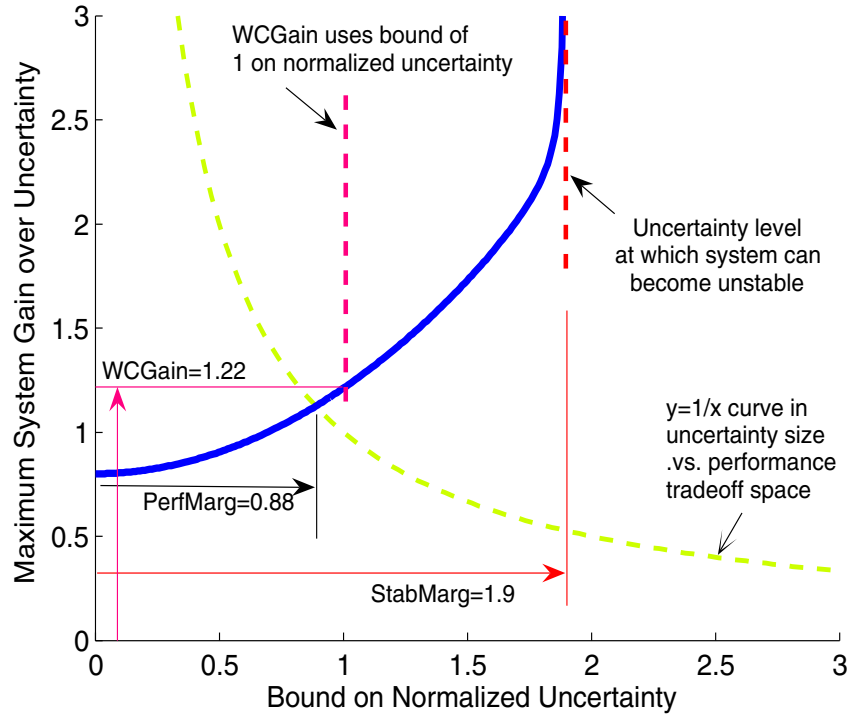



## Robust Stability Margin

The *robust stability margin*,  $\text{StabMarg}$ , is the size of the smallest deviation from nominal of the uncertain elements that leads to system instability.

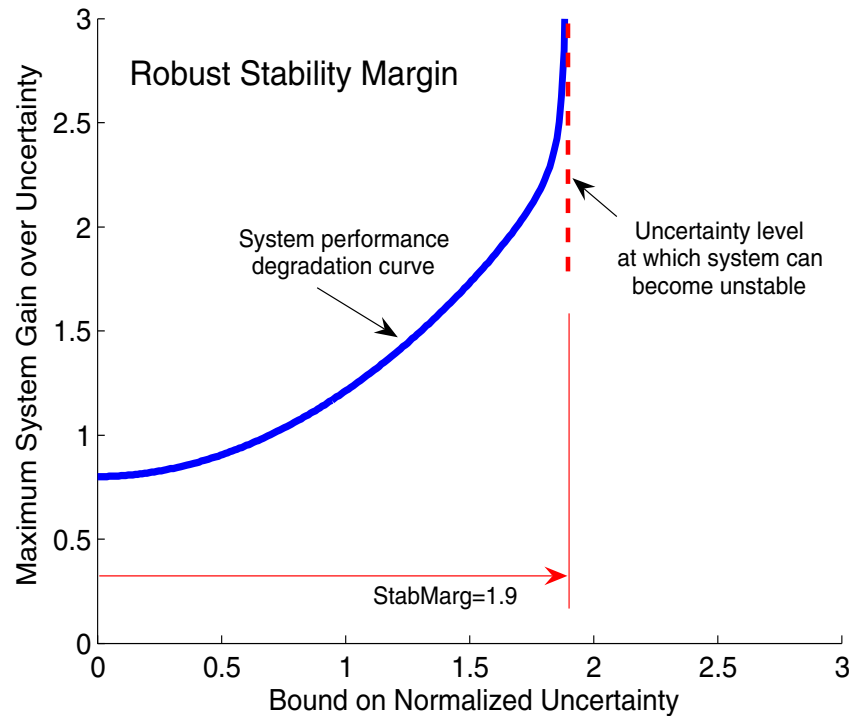

System instability is equivalent to the system gain becoming arbitrarily large, and hence characterized by the vertical line tangent to the asymptotic behavior of the performance degradation curve.

## Robust Performance Margin

The hyperbola is used to define the performance margin. Systems whose performance degradation curve intersects high on the hyperbola curve represent “non-robustly-performing systems” in that very small deviations of the uncertain elements from their nominal values can result in very large system gains. Conversely, an intersection low on the hyperbola represent “robustly-performing systems.”

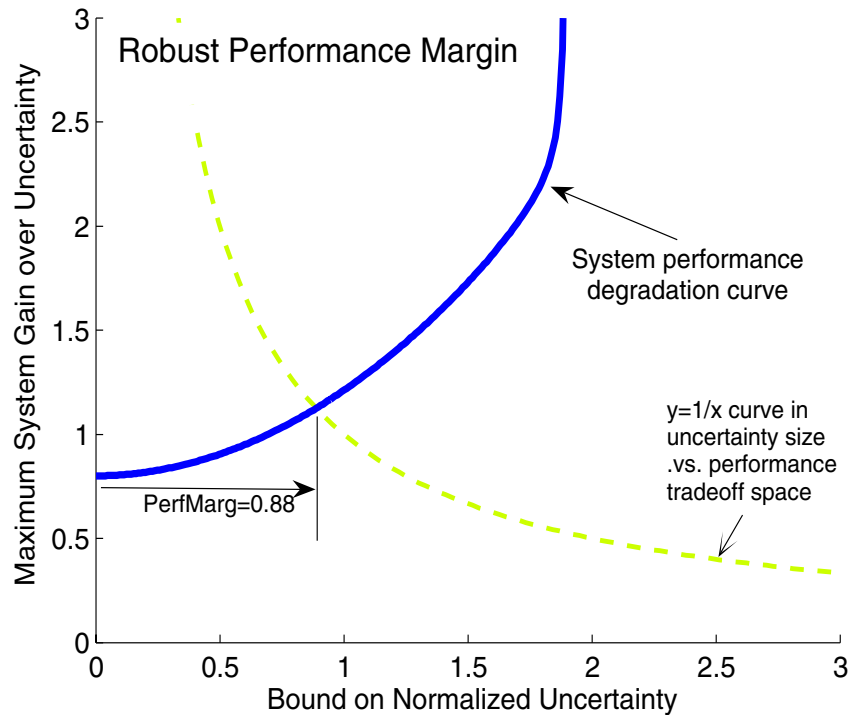

The point where the system performance degradation curve crosses the green line is used as a scalar measure of the robustness of a system to uncertainty. The horizontal coordinate of the crossing point is the *robust performance margin*, PerfMarg.

## Worst-Case Gain Measure

The worst-case gain measure is the maximum achievable system gain over all uncertain elements whose normalized size is bounded by 1.

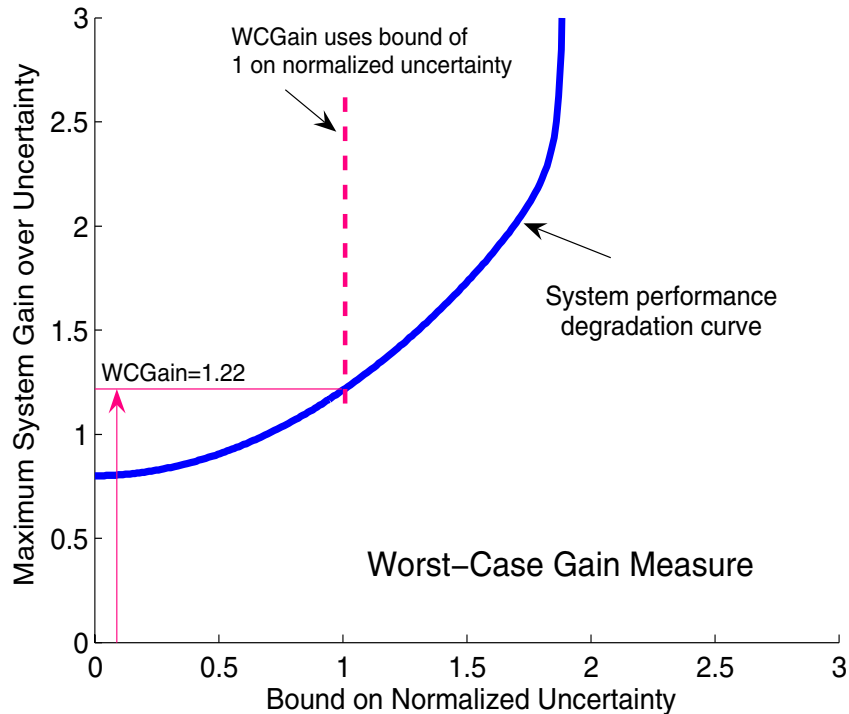

On the graph, this is the vertical coordinate of the performance degradation curve as it crosses the vertical line drawn at the uncertainty bound = 1.

Each measure captures a single scalar attribute of the *system performance degradation curve*. Mathematically, they are independent quantities, answering subtly different questions. Consequently, for two uncertain systems, sysA and sysB, it is possible that the StabMarg of sysA is larger than the StabMarg of sysB, though the PerfMarg of sysA is smaller than the PerfMarg of sysB. Nevertheless, they are useful metrics for concise description of the robustness of a system (uss or ufrd) due to various uncertain elements.



# Introduction to Linear Matrix Inequalities

---

Linear Matrix Inequalities (p. 8-2)

An introduction to the concept of linear matrix inequalities and what LMI functionality can do for you

LMIs and LMI Problems (p. 8-4)

The basic properties of LMIs

Further Mathematical Background (p. 8-9)

Detailed mathematical development of LMI theory

References (p. 8-10)

Relevant papers on linear matrix inequalities

## Linear Matrix Inequalities

Linear Matrix Inequalities (LMIs) and LMI techniques have emerged as powerful design tools in areas ranging from control engineering to system identification and structural design. Three factors make LMI techniques appealing:

- A variety of design specifications and constraints can be expressed as LMIs.
- Once formulated in terms of LMIs, a problem can be solved *exactly* by efficient convex optimization algorithms (the “LMI solvers”).
- While most problems with multiple constraints or objectives lack analytical solutions in terms of matrix equations, they often remain tractable in the LMI framework. This makes LMI-based design a valuable alternative to classical “analytical” methods.

See [9] for a good introduction to LMI concepts. The LMI Control Toolbox is designed as an easy and progressive gateway to the new and fast-growing field of LMIs:

- For users who occasionally need to solve LMI problems, the “LMI Editor” and the tutorial introduction to LMI concepts and LMI solvers provide for quick and easy problem solving.
- For more experienced LMI users, the “LMI Lab” (Chapter 8) offers a rich, flexible, and fully programmable environment to develop customized LMI-based tools.

### LMI Features

The Robust Control Toolbox LMI functionality serves two purposes:

- Provide state-of-the-art tools for the LMI-based analysis and design of robust control systems
- Offer a flexible and user-friendly environment to specify and solve general LMI problems (the LMI Lab)

:Examples of LMI-based analysis and design tools include

- Functions to analyze the robust stability and performance of uncertain systems with varying parameters (popov, quadstab, quadperf ...)

- Functions to design robust control with a mix of  $H_2$ ,  $H_\infty$ , and pole placement objectives (h2hinfsyn)
- Functions for synthesizing robust gain-scheduled  $H_\infty$  controllers (hinfgs)

For users interested in developing their own applications, the LMI Lab provides a general-purpose and fully programmable environment to specify and solve virtually any LMI problem. Note that the scope of this facility is by no means restricted to control-oriented applications.

---

**Note** The LMI Control Toolbox implements state-of-the-art interior-point LMI solvers. While these solvers are significantly faster than classical convex optimization algorithms, you should keep in mind that the complexity of LMI computations can grow quickly with the problem order (number of states). For example, the number of operations required to solve a Riccati equation is  $o(n^3)$  where  $n$  is the state dimension, while the cost of solving an equivalent “Riccati inequality” LMI is  $o(n^6)$ .

---

## LMIs and LMI Problems

A linear matrix inequality (LMI) is any constraint of the form

$$A(x) := A_0 + x_1 A_1 + \dots + x_N A_N < 0$$

where

- $x = (x_1, \dots, x_N)$  is a vector of unknown scalars (the *decision* or *optimization* variables)
- $A_0, \dots, A_N$  are given *symmetric* matrices
- $< 0$  stands for “negative definite,” i.e., the largest eigenvalue of  $A(x)$  is negative

Note that the constraints  $A(x) > 0$  and  $A(x) < B(x)$  are special cases of (1-1) since they can be rewritten as  $-A(x) < 0$  and  $A(x) - B(x) < 0$ , respectively.

The LMI (1-1) is a convex constraint on  $x$  since  $A(y) < 0$  and  $A(z) < 0$  imply that  $A\left(\frac{y+z}{2}\right) < 0$ . As a result,

- Its solution set, called the *feasible set*, is a convex subset of  $\mathbf{R}^N$
- Finding a solution  $x$  to (1-1), if any, is a convex optimization problem.

Convexity has an important consequence: even though (1-1) has no analytical solution in general, it can be solved numerically with guarantees of finding a solution when one exists. Note that a system of LMI constraints can be regarded as a single LMI since

$$\begin{cases} A_1(x) < 0 \\ \vdots \\ A_K(x) < 0 \end{cases} \text{ is equivalent to } A(x) := \text{diag}(A_1(x), \dots, A_K(x)) < 0$$

where  $\text{diag}(A_1(x), \dots, A_K(x))$  denotes the block-diagonal matrix with  $A_1(x), \dots, A_K(x)$  on its diagonal. Hence multiple LMI constraints can be imposed on the vector of decision variables  $x$  without destroying convexity.



In most control applications, LMIs do not naturally arise in the canonical form (1-1), but rather in the form

$$L(X_1, \dots, X_n) < R(X_1, \dots, X_n)$$

where  $L(\cdot)$  and  $R(\cdot)$  are affine functions of some structured *matrix* variables  $X_1, \dots, X_n$ . A simple example is the Lyapunov inequality

$$A^T X + XA < 0 \tag{8-1}$$

where the unknown  $X$  is a symmetric matrix. Defining  $x_1, \dots, x_N$  as the independent scalar entries of  $X$ , this LMI could be rewritten in the form (1-1). Yet it is more convenient and efficient to describe it in its natural form (1-2), which is the approach taken in the LMI Lab.

## The Three Generic LMI Problems

Finding a solution  $x$  to the LMI system

$$A(x) < 0 \tag{8-2}$$

is called the feasibility problem. Minimizing a convex objective under LMI constraints is also a convex problem. In particular, the *linear objective minimization problem*

$$\text{Minimize } c^T x \text{ subject to } A(x) < 0 \tag{8-3}$$

plays an important role in LMI-based design. Finally, the *generalized eigenvalue minimization problem*

$$\text{Minimize } \lambda \text{ subject to } \begin{cases} A(x) < \lambda B(x) \\ B(x) > 0 \\ C(x) < 0 \end{cases} \tag{8-4}$$

is quasi-convex and can be solved by similar techniques. It owes its name to the fact that is related to the largest generalized eigenvalue of the pencil  $(A(x), B(x))$ .

Many control problems and design specifications have LMI formulations [9]. This is especially true for Lyapunov-based analysis and design, but also for

optimal LQG control,  $H_\infty$  control, covariance control, etc. Further applications of LMIs arise in estimation, identification, optimal design, structural design [6, 7], matrix scaling problems, and so on. The main strength of LMI formulations is the ability to combine various design constraints or objectives in a numerically tractable manner.

A nonexhaustive list of problems addressed by LMI techniques includes the following:

- Robust stability of systems with LTI uncertainty ( $\mu$ -analysis) ([24], [21], [27])
- Robust stability in the face of sector-bounded nonlinearities (Popov criterion) ([22], [28], [13], [16])
- Quadratic stability of differential inclusions ([15], [8])
- Lyapunov stability of parameter-dependent systems [12]
- Input/state/output properties of LTI systems (invariant ellipsoids, decay rate, etc.) [9]
- Multi-model/multi-objective state feedback design ([4], [17], [3], [9], [10])
- Robust pole placement
- Optimal LQG control [9]
- Robust  $H_\infty$  control ([11], [14])
- Multi-objective  $H_\infty$  synthesis ([18], [23], [10], [18])
- Design of robust gain-scheduled controllers ([5], [2])
- Control of stochastic systems [9]
- Weighted interpolation problems [[9]

To hint at the principles underlying LMI design, let's review the LMI formulations of a few typical design objectives.

### Stability

The stability of the dynamic system

$$\dot{x} = Ax$$

is equivalent to the feasibility of

$$\text{Find } P = P^T \text{ such that } A^T P + P A < 0, P > I.$$

This can be generalized to linear differential inclusions (LDI)

$$\dot{x} = A(t)x$$

where  $A(t)$  varies in the convex envelope of a set of LTI models:

$$A(t) \in \text{Co}\{A_1, \dots, A_n\} = \left\{ \sum_{i=1}^n a_i A_i : a_i \geq 0, \sum_{i=1}^n a_i = 1 \right\}$$

A sufficient condition for the asymptotic stability of this LDI is the feasibility of

$$\text{Find } P = P^T \text{ such that } A_i^T P + P A_i < 0, \quad P > I.$$

### RMS gain

The random-mean-squares (RMS) gain of a stable LTI system

$$\begin{cases} \dot{x} = Ax + Bu \\ y = Cx + Du \end{cases}$$

is the largest input/output gain over all bounded inputs  $u(t)$ . This gain is the global minimum of the following linear objective minimization problem [1, 26, 25].

Minimize  $\gamma$  over  $X = X^T$  and  $\gamma$  such that

$$\begin{pmatrix} A^T X + XA & XB & C^T \\ B^T X & -\gamma I & D^T \\ C & D & -\gamma I \end{pmatrix} < 0$$

$$X > 0$$

### LQG performance

For a stable LTI system

$$G \begin{cases} \dot{x} = Ax + Bw \\ y = Cx \end{cases}$$

where  $w$  is a white noise disturbance with unit covariance, the LQG or  $H_2$  performance  $\|G\|_2$  is defined by

$$\begin{aligned}\|G\|_2^2 &:= \lim_{T \rightarrow \infty} E \left\{ \frac{1}{T} \int_0^T y^T(t) y(t) dt \right\} \\ &= \frac{1}{2\pi} \int_{-\infty}^{\infty} G^H(j\omega) G(j\omega) d\omega\end{aligned}$$

It can be shown that

$$\|G\|_2^2 = \inf \{ \text{Trace}(CPC^T) : AP + PA^T + BB^T < 0 \}$$

Hence  $\|G\|_2^2$  is the global minimum of the LMI problem

Minimize Trace ( $Q$ ) over the symmetric matrices  $P, Q$  such that

$$AP + PA^T + BB^T < 0$$

$$\begin{pmatrix} Q & CP \\ PC^T & P \end{pmatrix} > 0$$

Again this is a linear objective minimization problem since the objective Trace ( $Q$ ) is linear in the decision variables (free entries of  $P, Q$ ).

## Further Mathematical Background

Efficient interior-point algorithms are now available to solve the three generic LMI problems (1-3)–(1-5) defined in “The Three Generic LMI Problems” on page 8-5. These algorithms have a polynomial-time complexity. That is, the number  $N(\epsilon)$  of flops needed to compute an  $\epsilon$ -accurate solution is bounded by

$$M N^3 \log(V/\epsilon)$$

where  $M$  is the total row size of the LMI system,  $N$  is the total number of scalar decision variables, and  $V$  is a data-dependent scaling factor. The Robust Control Toolbox implements the Projective Algorithm of Nesterov and Nemirovski [20, 19]. In addition to its polynomial-time complexity, this algorithm does not require an initial feasible point for the linear objective minimization problem (1-4) or the generalized eigenvalue minimization problem (1-5).

Some LMI problems are formulated in terms of inequalities rather than strict inequalities. For instance, a variant of (1-4) is

$$\text{Minimize } c^T x \text{ subject to } A(x) < 0.$$

While this distinction is immaterial in general, it matters when  $A(x)$  can be made negative semi-definite but not negative definite. A simple example is

$$\text{Minimize } c^T x \text{ subject to } \begin{pmatrix} x & x \\ x & x \end{pmatrix} \geq 0.$$

**(8-5)**

Such problems cannot be handled directly by interior-point methods which require strict feasibility of the LMI constraints. A well-posed reformulation of (1-6) would be

$$\text{Minimize } c^T x \text{ subject to } x \geq 0.$$

Keeping this subtlety in mind, we always use strict inequalities in this manual.

## References

- [1] Anderson, B.D.O, and S. Vongpanitlerd, Network Analysis, Prentice-Hall, Englewood Cliffs, 1973.
- [2] Apkarian, P., P. Gahinet, and G. Becker, "Self-Scheduled  $H_\infty$  Control of Linear Parameter-Varying Systems," *Proc. Amer. Contr. Conf.*, 1994, pp. 856-860.
- [3] Bambang, R., E. Shimemura, and K. Uchida, "Mixed  $H_2/H_\infty$  Control with Pole Placement," State-Feedback Case, " *Proc. Amer. Contr. Conf.*, 1993, pp. 2777-2779.
- [4] Barmish, B.R., "Stabilization of Uncertain Systems via Linear Control," *IEEE Trans. Aut. Contr.*, AC-28 (1983), pp. 848-850.
- [5] Becker, G., Packard, P., "Robust Performance of Linear-Parametrically Varying Systems Using Parametrically-Dependent Linear Feedback," *Systems and Control Letters*, 23 (1994), pp. 205-215.
- [6] Bendsoe, M.P., A. Ben-Tal, and J. Zowe, "Optimization Methods for Truss Geometry and Topology Design," to appear in *Structural Optimization*.
- [7] Ben-Tal, A., and A. Nemirovski, "Potential Reduction Polynomial-Time Method for Truss Topology Design," to appear in *SIAM J. Contr. Opt.*
- [8] Boyd, S., and Q. Yang, "Structured and Simultaneous Lyapunov Functions for System Stability Problems," *Int. J. Contr.*, 49 (1989), pp. 2215-2240.
- [9] Boyd, S., L. El Ghaoui, E. Feron, V. Balakrishnan, *Linear Matrix Inequalities in Systems and Control Theory*, SIAM books, Philadelphia, 1994.
- [10] Chilali, M., and P. Gahinet, " $H_\infty$  Design with Pole Placement Constraints: an LMI Approach," to appear in *IEEE Trans. Aut. Contr.* Also in *Proc. Conf. Dec. Contr.*, 1994, pp. 553-558.
- [11] Gahinet, P., and P. Apkarian, "A Linear Matrix Inequality Approach to  $H_\infty$  Control," *Int. J. Robust and Nonlinear Contr.*, 4 (1994), pp. 421-448.
- [12] Gahinet, P., P. Apkarian, and M. Chilali, "Affine Parameter-Dependent Lyapunov Functions for Real Parametric Uncertainty," *Proc. Conf. Dec. Contr.*, 1994, pp. 2026-2031.
- [13] Haddad, W.M. and D.S. Bernstein, "Parameter-Dependent Lyapunov Functions, Constant Real Parameter Uncertainty, and the Popov Criterion in

- Robust Analysis and Synthesis: Part 1 and 2," *Proc. Conf. Dec. Contr.*, 1991, pp. 2274-2279 and 2632-2633.
- [14] Iwasaki, T., and R.E. Skelton, "All Controllers for the General  $H_\infty$  Control Problem: LMI Existence Conditions and State-Space Formulas," *Automatica*, 30 (1994), pp. 1307-1317.
- [15] Horisberger, H.P., and P.R. Belanger, "Regulators for Linear Time-Varying Plants with Uncertain Parameters," *IEEE Trans. Aut. Contr.*, AC-21 (1976), pp. 705-708.
- [16] How, J.P., and S.R. Hall, "Connection between the Popov Stability Criterion and Bounds for Real Parameter Uncertainty," *Proc. Amer. Contr. Conf.*, 1993, pp. 1084-1089.
- [17] Khargonekar, P.P., and M.A. Rotea, "Mixed  $H_2/H_\infty$  Control: a Convex Optimization Approach," *IEEE Trans. Aut. Contr.*, 39 (1991), pp. 824-837.
- [18] Masubuchi, I., A. Ohara, and N. Suda, "LMI-Based Controller Synthesis: A Unified Formulation and Solution," submitted to *Int. J. Robust and Nonlinear Contr.*, 1994.
- [19] Nemirovski, A., and P. Gahinet, "The Projective Method for Solving Linear Matrix Inequalities," *Proc. Amer. Contr. Conf.*, 1994, pp. 840-844.
- [20] Nesterov, Yu, and A. Nemirovski, *Interior Point Polynomial Methods in Convex Programming: Theory and Applications*, SIAM Books, Philadelphia, 1994.
- [21] Packard, A., and J.C. Doyle, "The Complex Structured Singular Value," *Automatica*, 29 (1994), pp. 71-109.
- [22] Popov, V.M., "Absolute Stability of Nonlinear Systems of Automatic Control," *Automation and Remote Control*, 22 (1962), pp. 857-875.
- [23] Scherer, C., "Mixed  $H_2/H_\infty$  Control," to appear in *Trends in Control: A European Perspective*, volume of the special contributions to the ECC 1995.
- [24] Stein, G. and J.C. Doyle, "Beyond Singular Values and Loop Shapes," *J. Guidance*, 14 (1991), pp. 5-16.
- [25] Vidyasagar, M., *Nonlinear System Analysis*, Prentice-Hall, Englewood Cliffs, 1992.

[26] Willems, J.C., "Least-Squares Stationary Optimal Control and the Algebraic Riccati Equation," *IEEE Trans. Aut. Contr.*, AC-16 (1971), pp. 621-634.

[27] Young, P. M., M. P. Newlin, and J. C. Doyle, "Let's Get Real," in *Robust Control Theory*, Springer Verlag, 1994, pp. 143-174.

[28] Zames, G., "On the Input-Output Stability of Time-Varying Nonlinear Feedback Systems, Part I and II," *IEEE Trans. Aut. Contr.*, AC-11 (1966), pp. 228-238 and 465-476.



# The LMI Lab

---

“Introduction” on page 9-2	An quick look at the LMI Lab, canonical forms of the LMI problem, and the tools available in the LMI Lab
Specifying a System of LMIs (p. 9-7)	How to set up a system of LMIs
Querying the LMI System Description (p. 9-19)	How to find out characteristics of your LMI system
LMI Solvers (p. 9-20)	How the LMI solvers work
From Decision to Matrix Variables and Vice Versa (p. 9-26)	The relationships between decision variables and matrix variables
Validating Results (p. 9-27)	Verifying your solutions
Modifying a System of LMIs (p. 9-28)	Adapting an existing system to a new problem
Advanced Topics (p. 9-31)	Topics for the experienced user
References (p. 9-42)	A list of relevant papers

## Introduction

The LMI Lab is a high-performance package for solving general LMI problems. It blends simple tools for the specification and manipulation of LMIs with powerful LMI solvers for three generic LMI problems. Thanks to a structure-oriented representation of LMIs, the various LMI constraints can be described in their natural block-matrix form. Similarly, the optimization variables are specified directly as *matrix variables* with some given structure. Once an LMI problem is specified, it can be solved numerically by calling the appropriate LMI solver. The three solvers `feasp`, `mincx`, and `gevp` constitute the computational engine of the LMI Control Toolbox. Their high performance is achieved through C-MEX implementation and by taking advantage of the particular structure of each LMI.

The LMI Lab offers tools to

- Specify LMI systems either symbolically with the LMI Editor or incrementally with the `lmivar` and `lmiterm` commands
- Retrieve information about existing systems of LMIs
- Modify existing systems of LMIs
- Solve the three generic LMI problems (feasibility problem, linear objective minimization, and generalized eigenvalue minimization)
- Validate results

This chapter gives a tutorial introduction to the LMI Lab as well as more advanced tips for making the most out of its potential. The tutorial material is also covered by the demo `lmidem`.

## Some Terminology

Any linear matrix inequality can be expressed in the canonical form

$$L(x) = L_0 + x_1 L_1 + \dots + x_N L_N < 0$$

where

- $L_0, L_1, \dots, L_N$  are given symmetric matrices
- $x = (x_1, \dots, x_N)^T \in \mathbf{R}^N$  is the vector of scalar variables to be determined. We refer to  $x_1, \dots, x_N$  as the *decision variables*. The names “design variables” and “optimization variables” are also found in the literature.

Even though this canonical expression is generic, LMIs rarely arise in this form in control applications. Consider for instance the Lyapunov inequality

$$A^T X + XA < 0 \tag{9-1}$$

where  $A = \begin{pmatrix} -1 & 2 \\ 0 & -2 \end{pmatrix}$  and the variable  $X = \begin{pmatrix} x_1 & x_2 \\ x_2 & x_3 \end{pmatrix}$  is a symmetric matrix.

Here the decision variables are the free entries  $x_1, x_2, x_3$  of  $X$  and the canonical form of this LMI reads

$$x_1 \begin{pmatrix} -2 & 2 \\ 2 & 0 \end{pmatrix} + x_2 \begin{pmatrix} 0 & -3 \\ -3 & 4 \end{pmatrix} + x_3 \begin{pmatrix} 0 & 0 \\ 0 & -4 \end{pmatrix} < 0 \tag{9-2}$$

Clearly this expression is less intuitive and transparent than (8-1). Moreover, the number of matrices involved in (8-2) grows roughly as  $n^2/2$  if  $n$  is the size of the  $A$  matrix. Hence, the canonical form is very inefficient from a storage viewpoint since it requires storing  $\mathcal{O}(n^2/2)$  matrices of size  $n$  when the single  $n$ -by- $n$  matrix  $A$  would be sufficient. Finally, working with the canonical form is also detrimental to the efficiency of the LMI solvers. For these various reasons, the LMI Lab uses a *structured representation* of LMIs. For instance, the expression  $A^T X + XA$  in the Lyapunov inequality (8-1) is explicitly described as a function of the matrix variable  $X$ , and only the  $A$  matrix is stored.

In general, LMIs assume a block matrix form where each block is an affine combination of the matrix variables. As a fairly typical illustration, consider the following LMI drawn from  $H_\infty$  theory

$$N^T \begin{pmatrix} A^T X + XA & XC^T & B \\ CX & -\gamma I & D \\ B^T & D^T & -\gamma I \end{pmatrix} N < 0 \tag{9-3}$$

where  $A, B, C, D, N$  are given matrices and the problem variables are  $X = X^T \in \mathbf{R}^{n \times n}$  and  $\gamma \in \mathbf{R}$ . We use the following terminology to describe such LMIs:

- $N$  is called the *outer factor*, and the block matrix

$$L(X, \gamma) = \begin{pmatrix} A^T X + XA & XC^T & B \\ CX & -\gamma I & D \\ B^T & D^T & -\gamma I \end{pmatrix}$$

is called the *inner factor*. The outer factor *needs not be square* and is *often absent*.

- $X$  and  $\gamma$  are the *matrix variables* of the problem. Note that scalars are considered as 1-by-1 matrices.
- The inner factor  $L(X, \gamma)$  is a symmetric *block matrix*, its block structure being characterized by the sizes of its diagonal blocks. By symmetry,  $L(X, \gamma)$  is entirely specified by the blocks on or above the diagonal.
- Each block of  $L(X, \gamma)$  is an affine expression in the matrix variables  $X$  and  $\gamma$ . This expression can be broken down into a sum of elementary *terms*. For instance, the block (1,1) contains two elementary terms:  $A^T X$  and  $XA$ .
- Terms are either *constant* or *variable*. Constant terms are fixed matrices like  $B$  and  $D$  above. Variable terms involve one of the matrix variables, like  $XA$ ,  $XC^T$ , and  $-\gamma I$  above.

The LMI (8-3) is specified by the list of terms in each block, as is any LMI regardless of its complexity.

As for the matrix variables  $X$  and  $\gamma$ , they are characterized by their dimensions and structure. Common structures include rectangular unstructured, symmetric, skew-symmetric, and scalar. More sophisticated structures are sometimes encountered in control problems. For instance, the matrix variable  $X$  could be constrained to the block-diagonal structure

$$X = \begin{pmatrix} x_1 & 0 & 0 \\ 0 & x_2 & x_3 \\ 0 & x_3 & x_4 \end{pmatrix}$$

Another possibility is the symmetric Toeplitz structure

$$X = \begin{pmatrix} x_1 & x_2 & x_3 \\ x_2 & x_1 & x_2 \\ x_3 & x_2 & x_1 \end{pmatrix}$$

Summing up, structured LMI problems are specified by declaring the matrix variables and describing the term content of each LMI. This term-oriented description is systematic and accurately reflects the specific structure of the LMI constraints. There is no built-in limitation on the number of LMIs that you can specify or on the number of blocks and terms in any given LMI. LMI systems of arbitrary complexity can therefore, be defined in the LMI Lab.

## Overview of the LMI Lab

The LMI Lab offers tools to specify, manipulate, and numerically solve LMIs. Its main purpose is to

- Allow for straightforward description of LMIs in their natural block-matrix form
- Provide easy access to the LMI solvers (optimization codes)
- Facilitate result validation and problem modification

The structure-oriented description of a given LMI system is stored as a single vector called the *internal representation* and generically denoted by `LMISYS` in the sequel. This vector encodes the structure and dimensions of the LMIs and matrix variables, a description of all LMI terms, and the related numerical data. It must be stressed that you need not attempt to read or understand the content of `LMISYS` since all manipulations involving this internal representation can be performed in a transparent manner with LMI-Lab tools.

The LMI Lab supports the following functionalities:

### Specification of a System of LMIs

LMI systems can be either specified as symbolic matrix expressions with the interactive graphical user interface `lmiedit`, or assembled incrementally with the two commands `lmivar` and `lmiterm`. The first option is more intuitive and transparent while the second option is more powerful and flexible.

### Information Retrieval

The interactive function `lmiinfo` answers qualitative queries about LMI systems created with `lmiedit` or `lmivar` and `lmiterm`. You can also use `lmiedit` to visualize the LMI system produced by a particular sequence of `lmivar/lmiterm` commands.

### Solvers for LMI Optimization Problems

General-purpose LMI solvers are provided for the three generic LMI problems defined on page 8-5. These solvers can handle very general LMI systems and matrix variable structures. They return a feasible or optimal vector of decision variables  $x^*$ . The corresponding values  $X_1^*, \dots, X_K^*$  of the matrix variables are given by the function `dec2mat`.

### Result Validation

The solution  $x^*$  produced by the LMI solvers is easily validated with the functions `evallmi` and `showlmi`. This allows a fast check and/or analysis of the results. With `evallmi`, all variable terms in the LMI system are evaluated for the value  $x^*$  of the decision variables. The left- and right-hand sides of each LMI then become constant matrices that can be displayed with `showlmi`.

### Modification of a System of LMIs

An existing system of LMIs can be modified in two ways:

- An LMI can be removed from the system with `dellmi`.
- A matrix variable  $X$  can be deleted using `delmvar`. It can also be instantiated, that is, set to some given matrix value. This operation is performed by `setmvar` and allows, for example, to fix some variables and solve the LMI problem with respect to the remaining ones.

## Specifying a System of LMIs

The LMI Lab can handle any system of LMIs of the form

$$N^T L(X_1, \dots, X_K) N < M^T R(X_1, \dots, X_K) M$$

where

- $X_1, \dots, X_K$  are matrix variables with some prescribed structure
- The left and right outer factors  $N$  and  $M$  are given matrices with *identical* dimensions
- The left and right inner factors  $L(\cdot)$  and  $R(\cdot)$  are symmetric block matrices with identical block structures, each block being an affine combination of  $X_1, \dots, X_K$  and their transposes.

---

**Important:** Throughout this chapter, “left-hand side” refers to what is on the “smaller” side of the inequality, and “right-hand side” to what is on the “larger” side. Accordingly,  $X$  is called the right-hand side and  $0$  the left-hand side of the LMI

$$0 < X$$

even when this LMI is written as  $X > 0$ .

---

The specification of an LMI system involves two steps:

- 1 Declare the dimensions and structure of each matrix variable  $X_1, \dots, X_K$ .
- 2 Describe the term content of each LMI.

This process creates the so-called *internal representation* of the LMI system. This computer description of the problem is used by the LMI solvers and in all subsequent manipulations of the LMI system. It is stored as a single vector called LMISYS.

There are two ways of generating the internal description of a given LMI system: (1) by a sequence of `lmivar/lmiterm` commands that build it incrementally, or (2) via the LMI Editor `lmiedit` where LMIs can be specified directly as symbolic matrix expressions. Though somewhat less flexible and powerful than the command-based description, the LMI Editor is more straightforward to use, hence particularly well-suited for beginners. Thanks to

its coding and decoding capabilities, it also constitutes a good tutorial introduction to `lmivar` and `lmiterm`. Accordingly, beginners may elect to skip the subsections on `lmivar` and `lmiterm` and to concentrate on the GUI-based specification of LMIs with `lmiedit`.

## A Simple Example

The following tutorial example is used to illustrate the specification of LMI systems with the LMI Lab tools. Run the demo `lmidem` to see a complete treatment of this example.

### Example 8.1

Consider a stable transfer function

$$G(s) = C(sI - A)^{-1}B \tag{9-4}$$

with four inputs, four outputs, and six states, and consider the set of input/output scaling matrices  $D$  with block-diagonal structure

$$D = \begin{pmatrix} d_1 & 0 & 0 & 0 \\ 0 & d_1 & 0 & 0 \\ 0 & 0 & d_2 & d_3 \\ 0 & 0 & d_4 & d_5 \end{pmatrix} \tag{9-5}$$

The following problem arises in the robust stability analysis of systems with time-varying uncertainty [4]:

Find, if any, a scaling  $D$  of structure (8-5) such that the largest gain across frequency of  $D G(s) D^{-1}$  is less than one.

This problem has a simple LMI formulation: there exists an adequate scaling  $D$  if the following feasibility problem has solutions:

Find two symmetric matrices  $X \in \mathbf{R}^{6 \times 6}$  and  $S = D^T D \in \mathbf{R}^{4 \times 4}$  such that



$$\begin{pmatrix} A^T X + XA + C^T S C & XB \\ B^T X & -S \end{pmatrix} < 0 \quad (9-6)$$

$$X > 0 \quad (9-7)$$

$$S > 1 \quad (9-8)$$

The LMI system (Equation 9-6, Equation 9-7, and Equation 9-8) can be described with the LMI Editor as outlined below. Alternatively, its internal description can be generated with `lmivar` and `lmiterm` commands as follows:

```
setlmis([])
X=lmivar(1,[6 1])
S=lmivar(1,[2 0;2 1])

% 1st LMI
lmiterm([1 1 1 X],1,A,'s')
lmiterm([1 1 1 S],C',C)
lmiterm([1 1 2 X],1,B)
lmiterm([1 2 2 S], 1,1)

% 2nd LMI
lmiterm([ 2 1 1 X],1,1)

% 3rd LMI
lmiterm([ 3 1 1 S],1,1)
lmiterm([3 1 1 0],1)

LMISYS = getlmis
```

Here the `lmivar` commands define the two matrix variables  $X$  and  $S$  while the `lmiterm` commands describe the various terms in each LMI. Upon completion, `getlmis` returns the internal representation `LMISYS` of this LMI system. The next three subsections give more details on the syntax and usage of these various commands. More information on how the internal representation is updated by `lmivar/lmiterm` can also be found in “How It All Works” on page 9-18.

## Initializing the LMI System

The description of an LMI system should begin with `setlmis` and end with `getlmis`. The function `setlmis` initializes the LMI system description. When specifying a new system, type

```
setlmis([])
```

To add on to an existing LMI system with internal representation `LMISO`, type

```
setlmis(LMISO)
```

## Specifying the LMI Variables

The matrix variables are declared one at a time with `lmivar` and are characterized by their structure. To facilitate the specification of this structure, the LMI Lab offers two predefined structure types along with the means to describe more general structures:

Type 1: **Symmetric block diagonal** structure. This corresponds to matrix variables of the form

$$X = \begin{pmatrix} D_1 & 0 & \dots & 0 \\ 0 & D_2 & \ddots & \vdots \\ \vdots & \ddots & \ddots & 0 \\ 0 & \dots & 0 & D_r \end{pmatrix}$$

where each diagonal block  $D_j$  is square and is either zero, a *full symmetric* matrix, or a *scalar* matrix

$$D_j = d \times I, \quad d \in \mathbf{R}$$

This type encompasses ordinary symmetric matrices (single block) and scalar variables (one block of size one).

Type 2: **Rectangular** structure. This corresponds to arbitrary rectangular matrices without any particular structure.

Type 3: **General** structures. This third type is used to describe more sophisticated structures and/or correlations between the matrix variables. The principle is as follows: each entry of  $X$  is specified independently as either 0,  $x_n$ , or  $-x_n$  where  $x_n$  denotes the  $n$ -th decision variable in the problem. For details on how to use Type 3,

see “Structured Matrix Variables” on page 9-31 below as well as the `lmivar` entry in the reference pages.

In “Example 8.1” on page 9-8, the matrix variables  $X$  and  $S$  are of Type 1. Indeed, both are symmetric and  $S$  inherits the block-diagonal structure (8-5) of  $D$ . Specifically,  $S$  is of the form

$$S = \begin{pmatrix} s_1 & 0 & 0 & 0 \\ 0 & s_1 & 0 & 0 \\ 0 & 0 & s_2 & s_3 \\ 0 & 0 & s_3 & s_4 \end{pmatrix}$$

After initializing the description with the command `setlmis([])`, these two matrix variables are declared by

```
lmivar(1,[6 1]) % X
lmivar(1,[2 0;2 1]) % S
```

In both commands, the first input specifies the structure type and the second input contains additional information about the structure of the variable:

- For a matrix variable  $X$  of Type 1, this second input is a matrix with two columns and as many rows as diagonal blocks in  $X$ . The first column lists the sizes of the diagonal blocks and the second column specifies their nature with the following convention:

1 → full symmetric block

0 → scalar block

-1 → zero block

In the second command, for instance, `[2 0;2 1]` means that  $S$  has two diagonal blocks, the first one being a 2-by-2 scalar block and the second one a 2-by-2 full block.

- For matrix variables of Type 2, the second input of `lmivar` is a two-entry vector listing the row and column dimensions of the variable. For instance, a 3-by-5 rectangular matrix variable would be defined by

```
lmivar(2,[3 5])
```

For convenience, `lmivar` also returns a “tag” that identifies the matrix variable for subsequent reference. For instance,  $X$  and  $S$  in “Example 8.1” could be defined by

```
X = lmivar(1,[6 1])
S = lmivar(1,[2 0;2 1])
```

The identifiers  $X$  and  $S$  are integers corresponding to the ranking of  $X$  and  $S$  in the list of matrix variables (in the order of declaration). Here their values would be  $X=1$  and  $S=2$ . Note that these identifiers still point to  $X$  and  $S$  after deletion or instantiation of some of the matrix variables. Finally, `lmivar` can also return the total number of decision variables allocated so far as well as the entry-wise dependence of the matrix variable on these decision variables (see the `lmivar` entry in the reference pages for more details).

## Specifying Individual LMIs

After declaring the matrix variables with `lmivar`, we are left with specifying the term content of each LMI. Recall that LMI terms fall into three categories:

- The *constant terms*, i.e., fixed matrices like  $I$  in the left-hand side of the LMI  $S > I$
- The *variable terms*, i.e., terms involving a matrix variable. For instance,  $A^T X$  and  $C^T S C$  in (8-6). Variable terms are of the form  $PXQ$  where  $X$  is a variable and  $P, Q$  are given matrices called the left and right *coefficients*, respectively.
- The *outer factors*

The following rule should be kept in mind when describing the term content of an LMI:

---

**Important:** Specify only the terms in the blocks on or above the diagonal. The inner factors being symmetric, this is sufficient to specify the entire LMI. *Specifying all blocks results in the duplication of off-diagonal terms, hence in the creation of a different LMI.* Alternatively, you can describe the blocks on or below the diagonal.

---

LMI terms are specified one at a time with `lmiterm`. For instance, the LMI

$$\begin{pmatrix} A^T X + XA + C^T S C & XB \\ B^T X & -S \end{pmatrix} < 0$$

is described by

```
lmiterm([1 1 1 1],1,A,'s')
lmiterm([1 1 1 2],C',C)
lmiterm([1 1 2 1],1,B)
lmiterm([1 2 2 2], 1,1)
```

These commands successively declare the terms  $A^T X + XA$ ,  $C^T S C$ ,  $XB$ , and  $-S$ . In each command, the first argument is a four-entry vector listing the term characteristics as follows:

- The first entry indicates to which LMI the term belongs. The value `m` means “left-hand side of the  $m$ -th LMI,” and `-m` means “right-hand side of the  $m$ -th LMI”
- The second and third entries identify the block to which the term belongs. For instance, the vector `[1 1 2 1]` indicates that the term is attached to the (1, 2) block
- The last entry indicates which matrix variable is involved in the term. This entry is 0 for constant terms,  $k$  for terms involving the  $k$ -th matrix variable  $X_k$ , and  $-k$  for terms involving  $X_k^T$  (here  $X$  and  $S$  are first and second variables in the order of declaration).

Finally, the second and third arguments of `lmiterm` contain the numerical data (values of the constant term, outer factor, or matrix coefficients  $P$  and  $Q$  for variable terms  $PXQ$  or  $PX^TQ$ ). These arguments must refer to existing MATLAB variables and be *real-valued*. See “Complex-Valued LMIs” on page 9-33 for the specification of LMIs with complex-valued coefficients.

Some shorthand is provided to simplify term specification. First, blocks are zero by default. Second, in *diagonal blocks* the extra argument `'s'` allows you to specify the conjugated expression  $AXB + B^T X^T A^T$  with a *single* `lmiterm` command. For instance, the first command specifies  $A^T X + XA$  as the “symmetrization” of  $XA$ . Finally, scalar values are allowed as shorthand for *scalar matrices*, i.e., matrices of the form  $\alpha I$  with  $\alpha$  scalar. Thus, a constant

term of the form  $\alpha I$  can be specified as the “scalar”  $\alpha$ . This also applies to the coefficients  $P$  and  $Q$  of variable terms. The dimensions of scalar matrices are inferred from the context and set to 1 by default. For instance, the third LMI  $S > I$  in “Example 8.3” on page 9-31 is described by

```
lmiterm([ 3 1 1 2],1,1)    % 1*S*1 = S
lmiterm([3 1 1 0],1)      % 1*I = I
```

Recall that by convention  $S$  is considered as the right-hand side of the inequality, which justifies the  $-3$  in the first command.

Finally, to improve readability it is often convenient to attach an identifier (tag) to each LMI and matrix variable. The variable identifiers are returned by `lmivar` and the LMI identifiers are set by the function `newlmi`. These identifiers can be used in `lmiterm` commands to refer to a given LMI or matrix variable. For the LMI system of “Example 8.1”, this would look like:

```
setlmis([])
X = lmivar(1,[6 1])
S = lmivar(1,[2 0;2 1])

BRL = newlmi
lmiterm([BRL 1 1 X],1,A,'s')
lmiterm([BRL 1 1 S],C',C)
lmiterm([BRL 1 2 X],1,B)
lmiterm([BRL 2 2 S], 1,1)

Xpos = newlmi
lmiterm([-Xpos 1 1 X],1,1)

Slmi = newlmi
lmiterm([-Slmi 1 1 S],1,1)
lmiterm([Slmi 1 1 0],1)
```

When the LMI system is completely specified, type

```
LMISYS = getlmis
```

This returns the internal representation `LMISYS` of this LMI system. This MATLAB description of the problem can be forwarded to other LMI-Lab functions for subsequent processing. The command `getlmis` must be used *only once* and after declaring *all* matrix variables and LMI terms.

Here the identifiers  $X$  and  $S$  point to the variables  $X$  and  $S$  while the tags  $BRL$ ,  $Xpos$ , and  $S1mi$  point to the first, second, and third LMI, respectively. Note that  $Xpos$  refers to the right-hand side of the second LMI. Similarly,  $X$  would indicate transposition of the variable  $X$ .

## Specifying LMIs With the LMI Editor

The LMI Editor `lmiedit` is a graphical user interface (GUI) to specify LMI systems in a straightforward symbolic manner. Typing

```
lmiedit
```

calls up a window with several editable text areas and various buttons.

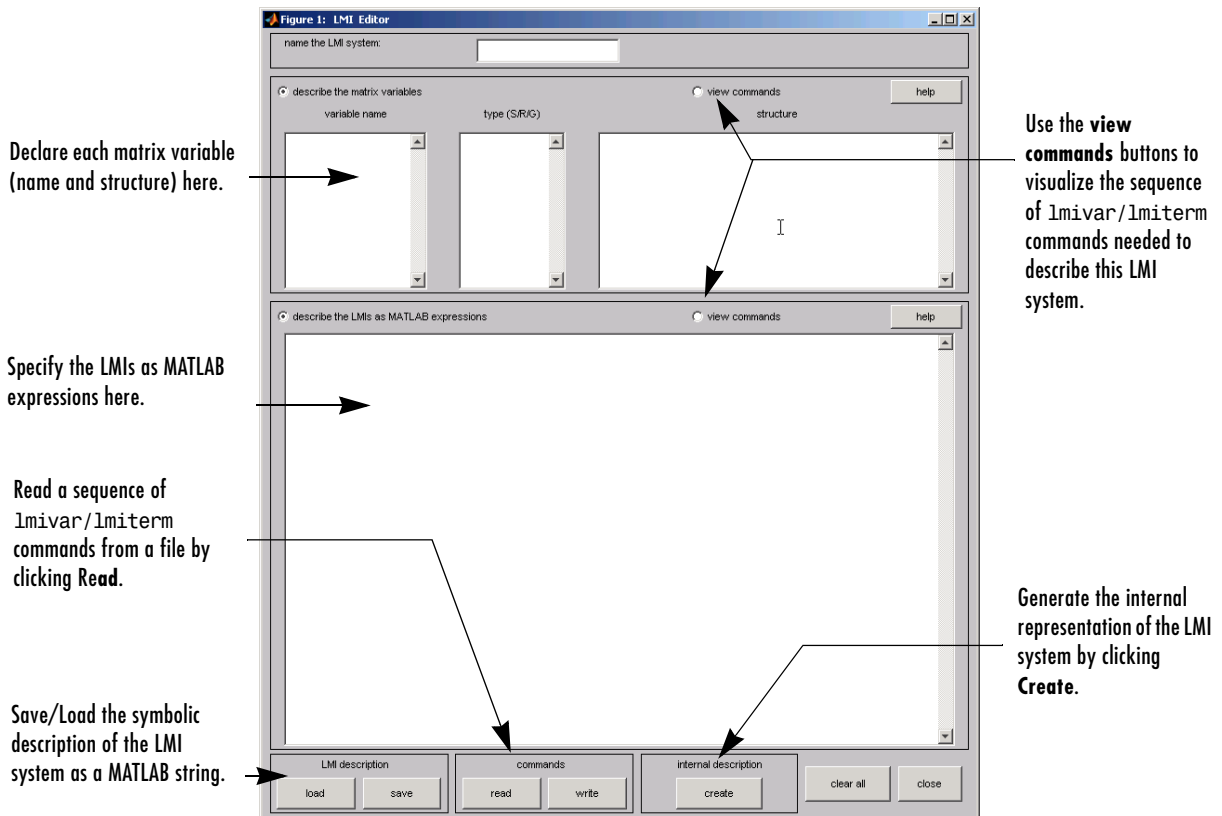

In more detail, to specify your LMI system,

- 1 Declare each matrix variable (name and structure) in the upper half of the worksheet. The structure is characterized by its type (S for symmetric block diagonal, R for unstructured, and G for other structures) and by an additional “structure” matrix. This matrix contains specific information about the structure and corresponds to the second argument of `lmivar` (see “Specifying the LMI Variables” on page 9-10 for details).

Please use *one line per matrix variable* in the text editing areas.

- 2 Specify the LMIs as MATLAB expressions in the lower half of the worksheet. For instance, the LMI

$$\begin{pmatrix} A^T X + XA & XB \\ B^T X & -I \end{pmatrix} < 0$$

is entered by typing

```
[a'*x+x*a x*b; b'*x 1] < 0
```

if `x` is the name given to the matrix variable `X` in the upper half of the worksheet. The left- and right-hand sides of the LMIs should be *valid* MATLAB expressions.

Once the LMI system is fully specified, the following tasks can be performed by clicking the corresponding button:

- Visualize the sequence of `lmivar/lmiterm` commands needed to describe this LMI system (view commands button). Conversely, the LMI system defined by a particular sequence of `lmivar/lmiterm` commands can be displayed as a MATLAB expression by clicking on the **describe...** buttons.

Beginners can use this facility as a tutorial introduction to the `lmivar` and `lmiterm` commands.

- Save the symbolic description of the LMI system as a MATLAB string (save button). This description can be reloaded later on by clicking the **load** button.
- Read a sequence of `lmivar/lmiterm` commands from a file (**read** button). You can then click on **describe the matrix variables** or **describe the LMIs** to visualize the symbolic expression of the LMI system specified by these



commands. The file should describe a single LMI system but may otherwise contain any sequence of MATLAB commands.

This feature is useful for code validation and debugging.

Write in a file the sequence of `lmivar`/`lmi term` commands needed to describe a particular LMI system (**write** button).

This is helpful to develop code and prototype MATLAB functions based on the LMI Lab.

- Generate the internal representation of the LMI system by clicking **create**. The result is written in a MATLAB variable named after the LMI system (if the “name of the LMI system” is set to `mylmi`, the internal representation is written in the MATLAB variable `mylmi`). Note that all LMI-related data should be defined in the MATLAB workspace at this stage.

The internal representation can be passed directly to the LMI solvers or any other LMI Lab function.

## Keyboard Shortcuts

As with `lmi term`, you can use various shortcuts when entering LMI expressions at the keyboard. For instance, zero blocks can be entered simply as `0` and need not be dimensioned. Similarly, the identity matrix can be entered as `1` without dimensioning. Finally, *upper diagonal* LMI blocks need not be fully specified. Rather, you can just type `(*)` in place of each such block.

## Limitations

Though fairly general, `lmiedit` is not as flexible as `lmi term` and the following limitations should be kept in mind:

- Parentheses cannot be used around matrix variables. For instance, the expression

$$(a*x+b)'*c + c'*(a*x+b)$$

is invalid when  $x$  is a variable name. By contrast,

$$(a+b)'*x + x'*(a+b)$$

is perfectly valid.

- Loops and `if` statements are ignored.
- When turning `lmi term` commands into a symbolic description of the LMI system, an error is issued if the first argument of `lmi term` cannot be

evaluated. Use the LMI and variable identifiers supplied by `newlmi` and `lmivar` to avoid such difficulties.

Figure 8-1 shows how to specify the feasibility problem of “Example 8.1” on page 9-8 with `lmiedit`.

## How It All Works

Users familiar with MATLAB may wonder how `lmivar` and `lmiterm` physically update the internal representation `LMISYS` since `LMISYS` is not an argument to these functions. In fact, all updating is performed through global variables for maximum speed. These global variables are initialized by `setlmis`, cleared by `getlmis`, and are not visible in the workspace. Even though this artifact is transparent from the user's viewpoint, be sure to

- Invoke `getlmis` only once and after completely specifying the LMI system
- Refrain from using the command `clear global` before the LMI system description is ended with `getlmis`

## Querying the LMI System Description

Recall that the full description of an LMI system is stored as a single vector called the internal representation. The user should not attempt to read or retrieve information directly from this vector. The Robust Control Toolbox provides three functions called `lmiinfo`, `lminbr`, and `matnbr` to extract and display all relevant information in a user-readable format.

### **lmiinfo**

`lmiinfo` is an interactive facility to retrieve qualitative information about LMI systems. This includes the number of LMIs, the number of matrix variables and their structure, the term content of each LMI block, etc. To invoke `lmiinfo`, enter

```
lmiinfo(LMISYS)
```

where `LMISYS` is the internal representation of the LMI system produced by `getlmis`.

### **lminbr and matnbr**

These two functions return the number of LMIs and the number of matrix variables in the system. To get the number of matrix variables, for instance, enter

```
matnbr(LMISYS)
```

## LMI Solvers

LMI solvers are provided for the following three generic optimization problems (here  $x$  denotes the vector of decision variables, i.e., of the free entries of the matrix variables  $X_1, \dots, X_K$ ):

- Feasibility problem

Find  $x \in \mathbf{R}^N$  (or equivalently matrices  $X_1, \dots, X_K$  with prescribed structure) that satisfies the LMI system

$$A(x) < B(x)$$

The corresponding solver is called `feasp`.

- Minimization of a linear objective under LMI constraints

Minimize  $c^T x$  over  $x \in \mathbf{R}^N$  subject to  $A(x) < B(x)$

The corresponding solver is called `mincx`.

- Generalized eigenvalue minimization problem

Minimize  $\lambda$  over  $x \in \mathbf{R}^N$  subject to

$$C(x) < D(x)$$

$$0 < B(x)$$

$$A(x) < \lambda B(x).$$

The corresponding solver is called `gevp`.

Note that  $A(x) < B(x)$  above is a shorthand notation for general structured LMI systems with decision variables  $x = (x_1, \dots, x_N)$ .

The three LMI solvers `feasp`, `mincx`, and `gevp` take as input the internal representation `LMISYS` of an LMI system and return a feasible or optimizing value  $x^*$  of the decision variables. The corresponding values of the matrix variables  $X_1, \dots, X_K$  are derived from  $x^*$  with the function `dec2mat`. These solvers are C-MEX implementations of the polynomial-time Projective Algorithm Projective Algorithm of Nesterov and Nemirovski [3, 2].

For generalized eigenvalue minimization problems, it is necessary to distinguish between the standard LMI constraints  $C(x) < D(x)$  and the linear-fractional LMIs

$$A(x) < \lambda B(x)$$

attached to the minimization of the generalized eigenvalue  $\lambda$ . When using `gevp`, you should follow these three rules to ensure proper specification of the problem:

- Specify the LMIs involving  $\lambda$  as  $A(x) < B(x)$  (*without* the  $\lambda$ )
- Specify them *last* in the LMI system. `gevp` systematically assumes that the last  $L$  LMIs are linear-fractional if  $L$  is the number of LMIs involving  $\lambda$
- Add the constraint  $0 < B(x)$  or any other constraint that enforces it. This positivity constraint is required for well-posedness of the problem and is not automatically added by `gevp` (see the reference pages for details).

An initial guess `xinit` for  $x$  can be supplied to `mincx` or `gevp`. Use `mat2dec` to derive `xinit` from given values of the matrix variables  $X_1, \dots, X_K$ . Finally, various options are available to control the optimization process and the solver behavior. These options are described in detail in the reference pages.

The following example illustrates the use of the `mincx` solver.

### Example 8.2

Consider the optimization problem

Minimize  $\text{Trace}(X)$  subject to

$$A^T X + XA + XBB^T X + Q < 0 \tag{9-9}$$

with data

$$A = \begin{pmatrix} -1 & -2 & 1 \\ 3 & 2 & 1 \\ 1 & -2 & -1 \end{pmatrix}; \quad B = \begin{pmatrix} 1 \\ 0 \\ 1 \end{pmatrix}; \quad Q = \begin{pmatrix} 1 & -1 & 0 \\ -1 & -3 & -12 \\ 0 & -12 & -36 \end{pmatrix}$$

It can be shown that the minimizer  $X^*$  is simply the stabilizing solution of the algebraic Riccati equation

$$A^T X + XA + XBB^T X + Q = 0$$

This solution can be computed directly with the Riccati solver `care` and compared to the minimizer returned by `mincx`.

From an LMI optimization standpoint, problem (8-9) is equivalent to the following linear objective minimization problem:

$$\text{Minimize Trace}(X) \quad \text{subject to} \quad \begin{pmatrix} A^T X + XA + Q & XB \\ B^T X & -I \end{pmatrix} < 0 \quad (9-10)$$

Since  $\text{Trace}(X)$  is a linear function of the entries of  $X$ , this problem falls within the scope of the `mincx` solver and can be numerically solved as follows:

- 1 Define the LMI constraint (8-9) by the sequence of commands

```
setlmis([])
X = lmivar(1,[3 1]) % variable X, full symmetric

lmiterm([1 1 1 X],1,a,'s')
lmiterm([1 1 1 0],q)
lmiterm([1 2 2 0], 1)
lmiterm([1 2 1 X],b',1)
```

```
LMIs = getlmis
```

- 2 Write the objective  $\text{Trace}(X)$  as  $c^T x$  where  $x$  is the vector of free entries of  $X$ . Since  $c$  should select the diagonal entries of  $X$ , it is obtained as the decision vector corresponding to  $X = I$ , that is,

```
c = mat2dec(LMIs,eye(3))
```

Note that the function `defcx` provides a more systematic way of specifying such objectives (see “Specifying  $c^T x$  Objectives for `mincx`” on page 9-36 for details).

- 3 Call `mincx` to compute the minimizer `xopt` and the global minimum

```
copt = c'*xopt of the objective:
options = [1e 5,0,0,0,0]
[copt,xopt] = mincx(LMIs,c,options)
```

Here `1e 5` specifies the desired relative accuracy on `copt`.

The following trace of the iterative optimization performed by `mincx` appears on the screen:

```
Solver for linear objective minimization under LMI constraints
```

Iterations : Best objective value so far

1		
2	8.511476	
3	13.063640	
***	new lower bound:	34.023978
4	15.768450	
***	new lower bound:	25.005604
5	17.123012	
***	new lower bound:	21.306781
6	17.882558	
***	new lower bound:	19.819471
7	18-339853	
***	new lower bound:	19.189417
8	18.552558	
***	new lower bound:	18.919668
9	18.646811	
***	new lower bound:	18.803708
10	18.687324	
***	new lower bound:	18.753903
11	18.705715	
***	new lower bound:	18.732574
12	18.712175	
***	new lower bound:	18.723491
13	18.714880	
***	new lower bound:	18.719624
14	18.716094	
***	new lower bound:	18.717986
15	18.716509	

```

***          new lower bound:          18.717297
16           18.716695
***          new lower bound:          18.716873

```

```

Result: feasible solution of required accuracy
      best objective value: 18.716695
      guaranteed relative accuracy: 9.50e 06
      f-radius saturation: 0.000% of R = 1.00e+09

```

The iteration number and the best value of  $c^T x$  at the current iteration appear in the left and right columns, respectively. Note that no value is displayed at the first iteration, which means that a feasible  $x$  satisfying the constraint (8-10) was found only at the second iteration. Lower bounds on the global minimum of  $c^T x$  are sometimes detected as the optimization progresses. These lower bounds are reported by the message

```
*** new lower bound: xxx
```

Upon termination, `mincx` reports that the global minimum for the objective  $\text{Trace}(X)$  is  $-18.716695$  with relative accuracy of at least  $9.5\text{-by-}10^{-6}$ . This is the value `copt` returned by `mincx`.

- 4** `mincx` also returns the optimizing vector of decision variables `xopt`. The corresponding optimal value of the matrix variable  $X$  is given by

```
Xopt = dec2mat(LMIs,xopt,X)
```

which returns

$$X_{\text{opt}} = \begin{pmatrix} -6.3542 & -5.8895 & 2.2046 \\ -5.8895 & -6.2855 & 2.2201 \\ 2.2046 & 2.2201 & -6.0771 \end{pmatrix}$$

This result can be compared with the stabilizing Riccati solution computed by `care`:

```
Xst = care(a,b,q, 1)
norm(Xopt-Xst)
```



```
ans =  
    6.5390e 05
```

## From Decision to Matrix Variables and Vice Versa

While LMIs are specified in terms of their matrix variables  $X_1, \dots, X_K$ , the LMI solvers optimize the vector  $x$  of free scalar entries of these matrices, called the decision variables. The two functions `mat2dec` and `dec2mat` perform the conversion between these two descriptions of the problem variables.

Consider an LMI system with three matrix variables  $X_1, X_2, X_3$ . Given particular values  $X1, X2, X3$  of these variables, the corresponding value `xdec` of the vector of decision variables is returned by `mat2dec`:

```
xdec = mat2dec(LMISYS,X1,X2,X3)
```

An error is issued if the number of arguments following `LMISYS` differs from the number of matrix variables in the problem (see `matnbr`).

Conversely, given a value `xdec` of the vector of decision variables, the corresponding value of the  $k$ -th matrix is given by `dec2mat`. For instance, the value  $X2$  of the second matrix variable is extracted from `xdec` by

```
X2 = dec2mat(LMISYS,xdec,2)
```

The last argument indicates that the second matrix variable is requested. It could be set to the matrix variable identifier returned by `lmivar`.

The total numbers of matrix variables and decision variables are returned by `matnbr` and `decnbr`, respectively. In addition, the function `decinfo` provides precise information about the mapping between decision variables and matrix variable entries (see the reference pages).

## Validating Results

The LMI Lab offers two functions to analyze and validate the results of an LMI optimization. The function `evallmi` evaluates all variable terms in an LMI system for a given value of the vector of decision variables, for instance, the feasible or optimal vector returned by the LMI solvers. Once this evaluation is performed, the left- and right-hand sides of a particular LMI are returned by `showlmi`.

In the LMI problem considered in “Example 8.2” on page 9-21, you can verify that the minimizer `xopt` returned by `mincx` satisfies the LMI constraint (8-10) as follows:

```
evlmi = evallmi(LMIs,xopt)
[lhs,rhs] = showlmi(evlmi,1)
```

The first command evaluates the system for the value `xopt` of the decision variables, and the second command returns the left- and right-hand sides of the first (and only) LMI. The negative definiteness of this LMI is checked by

```
eig(lhs-rhs)

ans =
    2.0387e 04
    3.9333e 05
    1.8917e 07
    4.6680e+01
```

## Modifying a System of LMIs

Once specified, a system of LMIs can be modified in several ways with the functions `dellmi`, `delmvar`, and `setmvar`.

### Deleting an LMI

The first possibility is to remove an entire LMI from the system with `dellmi`. For instance, suppose that the LMI system of “Example 8.1” on page 9-8 is described in `LMISYS` and that we want to remove the positivity constraint on  $X$ . This is done by

```
NEWSYS = dellmi(LMISYS,2)
```

where the second argument specifies deletion of the second LMI. The resulting system of two LMIs is returned in `NEWSYS`.

The LMI identifiers (*initial* ranking of the LMI in the LMI system) are not altered by deletions. As a result, the last LMI

$$S > I$$

remains known as the third LMI even though it now ranks second in the modified system. To avoid confusion, it is safer to refer to LMIs via the identifiers returned by `newlmi`. If `BRL`, `Xpos`, and `S1mi` are the identifiers attached to the three LMIs (8-6)–(8-8), `S1mi` keeps pointing to  $S > I$  even after deleting the second LMI by

```
NEWSYS = dellmi(LMISYS,Xpos)
```

### Deleting a Matrix Variable

Another way of modifying an LMI system is to delete a matrix variable, that is, to remove all variable terms involving this matrix variable. This operation is performed by `delmvar`. For instance, consider the LMI

$$A^T X + X A + B W + W^T B^T + I < 0$$

with variables  $X = X^T \in \mathbf{R}^{4 \times 4}$  and  $W \in \mathbf{R}^{2 \times 4}$ . This LMI is defined by

```
setlmis([])
X = lmivar(1,[4 1]) % X
W = lmivar(2,[2 4]) % W
```

```

lmiterm([1 1 1 X],1,A,'s')
lmiterm([1 1 1 W],B,1,'s')
lmiterm([1 1 1 0],1)

```

```
LMISYS = getlmis
```

To delete the variable  $W$ , type the command

```
NEWSYS = delmvar(LMISYS,W)
```

The resulting `NEWSYS` now describes the Lyapunov inequality

$$A^T X + X A + I < 0$$

Note that `delmvar` automatically removes all LMIs that depended only on the deleted matrix variable.

The matrix variable identifiers are not affected by deletions and continue to point to the same matrix variable. For subsequent manipulations, it is therefore advisable to refer to the remaining variables through their identifier. Finally, note that deleting a matrix variable is equivalent to setting it to the zero matrix of the same dimensions with `setmvar`.

## Instantiating a Matrix Variable

The function `setmvar` is used to set a matrix variable to some given value. As a result, this variable is removed from the problem and all terms involving it become constant terms. This is useful, for instance, to fix `setmvar` some variables and optimize with respect to the remaining ones.

Consider again “Example 8.1” on page 9-8 and suppose we want to know if the peak gain of  $G$  itself is less than one, that is, if

$$\|G\|_{\infty} < 1$$

This amounts to setting the scaling matrix  $D$  (or equivalently,  $S = D^T D$ ) to a multiple of the identity matrix. Keeping in mind the constraint  $S > I$ , a legitimate choice is  $S = 2 - \beta\psi - I$ . To set  $S$  to this value, enter

```
NEWSYS = setmvar(LMISYS,S,2)
```

The second argument is the variable identifier  $S$ , and the third argument is the value to which  $S$  should be set. Here the value 2 is shorthand for  $2$ -by- $I$ . The resulting system NEWSYS reads

$$\begin{pmatrix} A^T X + XA + 2C^T C & XB \\ B^T X & -2I \end{pmatrix} < 0$$
$$X > 0$$
$$2I > I$$

Note that the last LMI is now free of variable and trivially satisfied. It could, therefore, be deleted by

```
NEWSYS = dellmi(NEWSYS,3)
```

or

```
NEWSYS = dellmi(NEWSYS,S1mi)
```

if S1mi is the identifier returned by newlmi.

## Advanced Topics

This last section gives a few hints for making the most out of the LMI Lab. It is directed toward users who are comfortable with the basics described above.

### Structured Matrix Variables

Fairly complex matrix variable structures and interdependencies can be specified with `lmivar`. Recall that the symmetric block-diagonal or rectangular structures are covered by Types 1 and 2 of `lmivar` provided that the matrix variables are independent. To describe more complex structures or correlations between variables, you must use Type 3 and specify each entry of the matrix variables directly in terms of the free scalar variables of the problem (the so-called decision variables).

With Type 3, each entry is specified as either 0 or  $\pm x_n$  where  $x_n$  is the  $n$ -th decision variable. The following examples illustrate how to specify nontrivial matrix variable structures with `lmivar`. We first consider the case of uncorrelated matrix variables.

#### Example 8.3

Suppose that the problem variables include a 3-by-3 symmetric matrix  $X$  and a 3-by-3 symmetric Toeplitz matrix

$$Y = \begin{pmatrix} y_1 & y_2 & y_3 \\ y_2 & y_1 & y_2 \\ y_3 & y_2 & y_1 \end{pmatrix}$$

The variable  $Y$  has three independent entries, hence involves three decision variables. Since  $Y$  is independent of  $X$ , these decision variables should be labeled  $n + 1, n + 2, n + 3$  where  $n$  is the number of decision variables involved in  $X$ . To retrieve this number, define the variable  $X$  (Type 1) by

```
setlmis([])
[X,n] = lmivar(1,[3 1])
```

The second output argument  $n$  gives the total number of decision variables used so far (here  $n = 6$ ). Given this number,  $Y$  can be defined by

```
Y = lmivar(3,n+[1 2 3;2 1 2;3 2 1])
```

or equivalently by

```
Y = lmivar(3,toeplitz(n+[1 2 3]))
```

where `toeplitz` is a standard MATLAB function. For verification purposes, we can visualize the decision variable distributions in  $X$  and  $Y$  with `decinfo`:

```
lmis = getlmis  
decinfo(lmis,X)
```

```
ans =  
    1    2    4  
    2    3    5  
    4    5    6
```

```
decinfo(lmis,Y)
```

```
ans =  
    7    8    9  
    8    7    8  
    9    8    7
```

The next example is a problem with interdependent matrix variables.

### Example 8.4

Consider three matrix variables  $X$ ,  $Y$ ,  $Z$  with structure

$$X = \begin{pmatrix} x & 0 \\ 0 & y \end{pmatrix}, \quad Y = \begin{pmatrix} z & 0 \\ 0 & t \end{pmatrix}, \quad Z = \begin{pmatrix} 0 & -x \\ -t & 0 \end{pmatrix}$$

where  $x, y, z, t$  are independent scalar variables. To specify such a triple, first define the two independent variables  $X$  and  $Y$  (both of Type 1) as follows:

```
setlmis([])  
[X,n,sX] = lmivar(1,[1 0;1 0])  
[Y,n,sY] = lmivar(1,[1 0;1 0])
```

The third output of `lmivar` gives the entry-wise dependence of  $X$  and  $Y$  on the decision variables  $(x_1, x_2, x_3, x_4) := (x, y, z, t)$ :

```
sX =  
    1    0  
    0    2
```



$$sY = \begin{bmatrix} 3 & 0 \\ 0 & 4 \end{bmatrix}$$

Using Type 3 of `lmivar`, you can now specify the structure of  $Z$  in terms of the decision variables  $x_1 = x$  and  $x_4 = t$ :

$$[Z, n, sZ] = \text{lmivar}(3, [0 \quad sX(1,1); -sY(2,2) \quad 0])$$

Since `sX(1,1)` refers to  $x_1$  while `sY(2,2)` refers to  $x_4$ , this defines the variable

$$Z = \begin{pmatrix} 0 & -x_1 \\ -x_4 & 0 \end{pmatrix} = \begin{pmatrix} 0 & -x \\ -t & 0 \end{pmatrix}$$

as confirmed by checking its entry-wise dependence on the decision variables:

$$sZ = \begin{bmatrix} 0 & 1 \\ 4 & 0 \end{bmatrix}$$

## Complex-Valued LMIs

The LMI solvers are written for real-valued matrices and cannot directly handle LMI problems involving complex-valued matrices. However, complex-valued LMIs can be turned into real-valued LMIs by observing that a complex Hermitian matrix  $L(x)$  satisfies

$$L(x) < 0$$

if and only if

$$\begin{pmatrix} \text{Re}(L(x)) & \text{Im}(L(x)) \\ -\text{Im}(L(x)) & \text{Re}(L(x)) \end{pmatrix} < 0$$

This suggests the following systematic procedure for turning complex LMIs into real ones:

- Decompose every complex matrix variable  $X$  as

$$X = X_1 + jX_2$$

where  $X_1$  and  $X_2$  are real

- Decompose every complex matrix coefficient  $A$  as

$$A = A_1 + jA_2$$

where  $A_1$  and  $A_2$  are real

- Carry out all complex matrix products. This yields affine expressions in  $X_1$ ,  $X_2$  for the real and imaginary parts of each LMI, and an equivalent real-valued LMI is readily derived from the above observation.

For LMIs without outer factor, a streamlined version of this procedure consists of replacing any occurrence of the matrix variable  $X = X_1 + jX_2$  by

$$\begin{pmatrix} X_1 & X_2 \\ -X_2 & X_1 \end{pmatrix}$$

and any fixed matrix  $A = A_1 + jA_2$ , including real ones, by

$$\begin{pmatrix} A_1 & A_2 \\ -A_2 & A_1 \end{pmatrix}$$

For instance, the real counterpart of the LMI system

$$M^H X M < X, \quad X = X^H > I \tag{9-11}$$

reads (given the decompositions  $M = M_1 + jM_2$  and  $X = X_1 + jX_2$  with  $M_j, X_j$  real):

$$\begin{pmatrix} M_1 & M_2 \\ -M_2 & M_1 \end{pmatrix}^T \begin{pmatrix} X_1 & X_2 \\ -X_2 & X_1 \end{pmatrix} \begin{pmatrix} M_1 & M_2 \\ -M_2 & M_1 \end{pmatrix} < \begin{pmatrix} X_1 & X_2 \\ -X_2 & X_1 \end{pmatrix}$$

$$\begin{pmatrix} X_1 & X_2 \\ -X_2 & X_1 \end{pmatrix} < I$$

Note that  $X = X^H$  in turn requires that  $X_1 = X_1^H$  and  $X_2 + X_2^T = 0$ . Consequently,  $X_1$  and  $X_2$  should be declared as symmetric and skew-symmetric matrix variables, respectively.

Assuming, for instance, that  $M \in \mathbf{C}^{5 \times 5}$ , the LMI system (8-11) would be specified as follows:

```

M1=real(M), M2=imag(M)
bigM=[M1 M2;-M2 M1]
setlmis([])

% declare bigX=[X1 X2;-X2 X1] with X1=X1' and X2+X2'=0:

[X1,n1,sX1] = lmivar(1,[5 1])
[X2,n2,sX2] = lmivar(3,skewdec(5,n1))
bigX = lmivar(3,[sX1 sX2;-sX2 sX1])

% describe the real counterpart of (1.12):

lmiterm([1 1 1 0],1)
lmiterm([ 1 1 1 bigX],1,1)
lmiterm([2 1 1 bigX],bigM',bigM)
lmiterm([ 2 1 1 bigX],1,1)

lmis = getlmis

```

Note the three-step declaration of the structured matrix variable  $\text{bigX} =$

$$\begin{pmatrix} X_1 & X_2 \\ -X_2 & X_1 \end{pmatrix}:$$

- 1** Specify  $X_1$  as a (real) symmetric matrix variable and save its structure description  $sX1$  as well as the number  $n1$  of decision variables used in  $X_1$ .
- 2** Specify  $X_2$  as a skew-symmetric matrix variable using Type 3 of `lmivar` and the utility `skewdec`. The command `skewdec(5,n1)` creates a 5-by-5 skew-symmetric structure depending on the decision variables  $n1 + 1, n1 + 2, \dots$
- 3** Define the structure of  $\text{bigX}$  in terms of the structures  $sX1$  and  $sX2$  of  $X_1$  and  $X_2$ .

See the previous subsection for more details on such structure manipulations.

## Specifying $c^T x$ Objectives for mincx

The LMI solver `mincx` minimizes linear objectives of the form  $c^T x$  where  $x$  is the vector of decision variables. In most control problems, however, such objectives are expressed in terms of the matrix variables rather than of  $x$ . Examples include  $\text{Trace}(X)$  where  $X$  is a symmetric matrix variable, or  $u^T X u$  where  $u$  is a given vector.

The function `defcx` facilitates the derivation of the  $c$  vector when the objective is an affine function of the *matrix variables*. For the sake of illustration, consider the linear objective

$$\text{Trace}(X) + x_0^T P x_0$$

where  $X$  and  $P$  are two symmetric variables and  $x_0$  is a given vector. If `lmisys` is the internal representation of the LMI system and if  $x_0$ ,  $X$ ,  $P$  have been declared by

```
x0 = [1;1]
setlmis([])
X = lmivar(1,[3 0])
P = lmivar(1,[2 1])
:
:
lmisys = getlmis
```

the  $c$  vector such that  $c^T x = \text{Trace}(X) + x_0^T P x_0$  can be computed as follows:

```
n = decnbr(lmisys)
c = zeros(n,1)

for j=1:n,
    [Xj,Pj] = defcx(lmisys,j,X,P)
    c(j) = trace(Xj) + x0'*Pj*x0
end
```

The first command returns the number of decision variables in the problem and the second command dimensions  $c$  accordingly. Then the `for` loop performs the following operations:

- 1 Evaluate the matrix variables  $X$  and  $P$  when all entries of the decision vector  $x$  are set to zero except  $x_j := 1$ . This operation is performed by the function `defcx`. Apart from `lmisys` and  $j$ , the inputs of `defcx` are the identifiers  $X$  and

$P$  of the variables involved in the objective, and the outputs  $X_j$  and  $P_j$  are the corresponding values.

- 2 Evaluate the objective expression for  $X := X_j$  and  $P := P_j$ . This yields the  $j$ -th entry of  $c$  by definition.

In our example the result is

```
c =
    3
    1
    2
    1
```

Other objectives are handled similarly by editing the following generic skeleton:

```
n = decnbr( LMI system )
c = zeros(n,1)
for j=1:n,
    [ matrix values ] = defcx( LMI system, j,
matrix identifiers)
    c(j) = objective(matrix values)
end
```

## Feasibility Radius

When solving LMI problems with `feasp`, `mincx`, or `gevp`, it is possible to constrain the solution  $x$  to lie in the ball

$$x^T x < R^2$$

where  $R > 0$  is called the *feasibility radius*. This specifies a maximum (Euclidean norm) magnitude for  $x$  and avoids getting solutions of very large norm. This may also speed up computations and improve numerical stability. Finally, the feasibility radius bound regularizes problems with redundant variable sets. In rough terms, the set of scalar variables is redundant when an equivalent problem could be formulated with a smaller number of variables.

The feasibility radius  $R$  is set by the third entry of the options vector of the LMI solvers. Its default value is  $R = 109$ . Setting  $R$  to a negative value means “no rigid bound,” in which case the feasibility radius is increased during the

optimization if necessary. This “flexible bound” mode may yield solutions of large norms.

## Well-Posedness Issues

The LMI solvers used in the LMI Lab are based on interior-point optimization techniques. To compute feasible solutions, such techniques require that the system of LMI constraints be strictly feasible, that is, the feasible set has a nonempty interior. As a result, these solvers may encounter difficulty when the LMI constraints are feasible but not *strictly feasible*, that is, when the LMI

$$L(x) \leq 0$$

has solutions while

$$L(x) < 0$$

has no solution.

For feasibility problems, this difficulty is automatically circumvented by `fesp`, which reformulates the problem

$$\text{Find } x \text{ such that } L(x) \leq 0 \tag{9-12}$$

as

$$\text{Minimize } t \text{ subject to } Lx < t \times I. \tag{9-13}$$

In this modified problem, the LMI constraint is always strictly feasible in  $x, t$  and the original LMI (8-12) is feasible if and only if the global minimum  $t_{\min}$  of (8-13) satisfies

$$t_{\min} \leq 0$$

For feasible but not strictly feasible problems, however, the computational effort is typically higher as `fesp` strives to approach the global optimum  $t_{\min} = 0$  to a high accuracy.

For the LMI problems addressed by `mincx` and `gevp`, nonstrict feasibility generally causes the solvers to fail and to return an “infeasibility” diagnosis. Although there is no universal remedy for this difficulty, it is sometimes possible to eliminate underlying algebraic constraints to obtain a strictly feasible problem with fewer variables.

Another issue has to do with homogeneous feasibility problems such as

$$A^T P + P A < 0, \quad P > 0$$

While this problem is technically well-posed, the LMI optimization is likely to produce solutions close to zero (the trivial solution of the nonstrict problem). To compute a nontrivial Lyapunov matrix and easily differentiate between feasibility and infeasibility, replace the constraint  $P > 0$  by  $P > \alpha I$  with  $\alpha > 0$ . Note that this does not alter the problem due to its homogeneous nature.

## Semi-Definite $B(x)$ in gevp Problems

Consider the generalized eigenvalue minimization problem

$$\text{Minimize } \lambda \text{ subject to } A(x) < \lambda B(x), B(x) > 0, C(x) < 0. \quad (9-14)$$

Technically, the positivity of  $B(x)$  for some  $x \in \mathbf{R}^n$  is required for the well-posedness of the problem and the applicability of polynomial-time interior-point methods. Hence problems where

$$B(x) = \begin{pmatrix} B_1(x) & 0 \\ 0 & 0 \end{pmatrix}, \text{ with } B_1(x) > 0 \text{ strictly feasible}$$

cannot be directly solved with gevp. A simple remedy consists of replacing the constraints

$$A(x) < B(x), \quad B(x) > 0$$

by

$$A(x) < \begin{pmatrix} Y & 0 \\ 0 & 0 \end{pmatrix}, \quad Y < \lambda B_1(x), \quad B_1(x) > 0$$

where  $Y$  is an additional symmetric variable of proper dimensions. The resulting problem is equivalent to (8-14) and can be solved directly with gevp.

## Efficiency and Complexity Issues

As explained in the beginning of the chapter, the term-oriented description of LMIs used in the LMI Lab typically leads to higher efficiency than the canonical representation

$$A_0 + x_1 A_1 + \dots + x_N A_N < 0.$$

(9-15)

This is no longer true, however, when the number of variable terms is nearly equal to or greater than the number  $N$  of decision variables in the problem. If your LMI problem has few free scalar variables but many terms in each LMI, it is therefore preferable to rewrite it as (8-15) and to specify it in this form. Each scalar variable  $x_j$  is then declared independently and the LMI terms are of the form  $x_j A_j$ .

If  $M$  denotes the total row size of the LMI system and  $N$  the total number of scalar decision variables, the flop count per iteration for the `feasp` and `mincx` solvers is proportional to

- $N^3$  when the least-squares problem is solved via Cholesky factorization of the Hessian matrix (default) [2]
- $M$ -by- $N^2$  when numerical instabilities warrant the use of QR factorization instead

While the theory guarantees a worst-case iteration count proportional to  $M$ , the number of iterations actually performed grows slowly with  $M$  in most problems. Finally, while `feasp` and `mincx` are comparable in complexity, `gevp` typically demands more computational effort. Make sure that your LMI problem cannot be solved with `mincx` before using `gevp`.

### **Solving $M + P^T X Q + Q^T X^T P < 0$**

In many output-feedback synthesis problems, the design can be performed in two steps:

- 1 Compute a closed-loop Lyapunov function via LMI optimization.
- 2 Given this Lyapunov function, derive the controller state-space matrices by solving an LMI of the form

$$M + P^T X Q + Q^T X^T P < 0$$

(9-16)

where  $M, P, Q$  are given matrices and  $X$  is an unstructured  $m$ -by- $n$  matrix variable.



It turns out that a particular solution  $X_c$  of (8-16) can be computed via simple linear algebra manipulations [1]. Typically,  $X_c$  corresponds to the center of the ellipsoid of matrices defined by (8-16).

The function `basiclmi` returns the “explicit” solution  $X_c$ :

```
Xc = basiclmi(M,P,Q)
```

Since this central solution sometimes has large norm, `basiclmi` also offers the option of computing an approximate least-norm solution of (8-16). This is done by

```
X = basiclmi(M,P,Q, 'Xmin')
```

and involves LMI optimization to minimize  $\|X\|$ .

## References

- [1] Gahinet, P., and P. Apkarian, “A Linear Matrix Inequality Approach to  $H_\infty$  Control,” *Int. J. Robust and Nonlinear Contr.*, 4 (1994), pp. 421–448.
- [2] Nemirovski, A., and P. Gahinet, “The Projective Method for Solving Linear Matrix Inequalities,” *Proc. Amer. Contr. Conf.*, 1994, pp. 840–844.
- [3] Nesterov, Yu, and A. Nemirovski, *Interior Point Polynomial Methods in Convex Programming: Theory and Applications*, SIAM Books, Philadelphia, 1994.
- [4] Shamma, J.S., “Robustness Analysis for Time-Varying Systems,” *Proc. Conf. Dec. Contr.*, 1992, pp. 3163–3168.

# Function Reference

---

This chapter gives a detailed description of all Robust Control Toolbox functions. Functions are grouped by application in tables at the beginning of this chapter, then they are listed alphabetically. In addition, information on each function is available through the online Help facility.

Functions — Categorical List (p. 10-2) Lists the Robust Control Toolbox functions according to their purpose.

Functions — Alphabetical List (p. 10-10) Lists the Robust Control Toolbox functions alphabetically.

## Functions – Categorical List

### Uncertain Elements

<code>ucomplex</code>	Uncertain complex parameter
<code>ucomplexm</code>	Uncertain complex matrix
<code>udyn</code>	Uncertain dynamics
<code>ultidyn</code>	Uncertain linear time-invariant object
<code>ureal</code>	Uncertain real parameter

### Uncertain Matrices and Systems

<code>umat</code>	Plant augmentation for state-space models
<code>uss</code>	Plant augmentation for transfer functions
<code>ufrd</code>	General multivariable interconnected system
<code>randatom</code>	Create a random uncertain element
<code>randumat</code>	Create a random uncertain matrix
<code>randuss</code>	Create a random uncertain state-space model

### Manipulation of Uncertain Models

<code>isuncertain</code>	True for uncertain systems
<code>simplify</code>	Simplify representation of an uncertain object
<code>usample</code>	Generate random samples of an uncertain object
<code>usubs</code>	Substitutes values for uncertain elements
<code>gridureal</code>	Grid real parameters over their range
<code>lftdata</code>	Extract LFT data from uncertain objects
<code>uss/ssbal</code>	Diagonal state/uncertainty scaling for an uncertain system

## Interconnection of Uncertain Models

<code>imp2exp</code>	Converts implicit LFT relationship to explicit I/O
<code>sysic</code>	Form interconnections of LTI and uncertain objects
<code>iconnect</code>	Creates an interconnection object (alternative to <code>sysic</code> )
<code>icsignal</code>	Creates an ICsignal object for equations used with <code>iconnect</code>
<code>imp2exp</code>	Creates an identically-zero ICsignal used with <code>iconnect</code>

## Model Order Reduction

<code>reduce</code>	Main interface to model approximation algorithms
<code>balancmr</code>	Balanced truncation model reduction
<code>bstmr</code>	Balanced stochastic truncation model reduction
<code>hankelmr</code>	Optimal Hankel norm model approximation
<code>modreal</code>	Schur balanced truncation model reduction
<code>ncfmr</code>	Balanced normalized coprime factor model reduction
<code>schurmr</code>	Schur balanced truncation model reduction
<code>slowfast</code>	State-space slow-fast decomposition
<code>stabproj</code>	State-space stable/anti-stable decomposition
<code>imp2ss</code>	Impulse response to state-space approximation

## Robustness and Worst-Case Analysis

<code>cpmargin</code>	Coprime stability margin of plant-controller feedback loop
<code>gapmetric</code>	Compute the gap and the Vinnicombe gap metric
<code>loopmargin</code>	Comprehensive analysis of feedback loops
<code>loopsens</code>	Sensitivity functions of feedback loops
<code>mussv</code>	Bounds on the structured singular value ( $\mu$ )
<code>mussvextract</code>	Extracts data from mussv output structure
<code>ncfmargin</code>	Normalized coprime stability margin of feedback loop
<code>popov</code>	Test for robust stability with Popov criterion
<code>robustperf</code>	Robust performance of uncertain systems
<code>robuststab</code>	Stability margins of uncertain systems
<code>robopt</code>	Creates a robuststab/robustperf options object
<code>wcnorm</code>	Worst-case norm of an uncertain matrix
<code>wcgain</code>	Worst-case gain of an uncertain system
<code>wcgopt</code>	Creates a wcnorm/wcgain options objects
<code>wcmargin</code>	Worst-case gain/phase margins for feedback loops
<code>wcsens</code>	Worst-case sensitivity functions of feedback loops

## Robustness Analysis for Parameter-Dependent Systems (P-Systems)

<code>psys</code>	Specify a parameter-dependent system (P-system)
<code>psinfo</code>	Query characteristics of a P-system
<code>ispsys</code>	True for parameter-dependent systems
<code>pvec</code>	Specify a vector of uncertain or time-varying parameters
<code>pvinfos</code>	Query characteristics of a parameter vector
<code>polydec</code>	Compute polytopic coordinates with respect to box corners
<code>uss</code>	Convert affine P-systems to uncertain state-space models
<code>aff2pol</code>	Convert affine P-systems to polytopic representation
<code>quadstab</code>	Assess quadratic stability of parameter-dependent systems
<code>quadperf</code>	Assess quadratic Hinf performance of P-systems
<code>pdlstab</code>	Test robust stability using parametric Lyapunov functions
<code>decay</code>	Compute quadratic decay rate
<code>pdsimul</code>	Simulate P-systems along parameter trajectories

## Controller Synthesis

augw	Augments plant weights for mixed-sensitivity control design
h2hinfosyn	Mixed $H_2/H_\infty$ controller synthesis
h2syn	$H_2$ controller synthesis.
hinfosyn	$H_\infty$ controller synthesis.
sdhinfosyn	$H_\infty$ controller synthesis. for continuous sampled-data system
loopsyn	$H_\infty$ loop shaping controller synthesis
ltrsyn	Loop-transfer recovery controller synthesis
mixsyn	$H_\infty$ mixed-sensitivity controller synthesis
ncfsyn	$H_\infty$ normalized coprime factor controller synthesis
mkfilter	Construct a shaping filter

## $\mu$ -Synthesis

cmslsyn	Constant matrix $\mu$ -synthesis
dksyn	Synthesis of a robust controller by $\mu$ -synthesis
dkitopt	Create a dksyn options object
drawmag	Interactive mouse-based sketching and fitting tool
fitfrd	Fit frequency-dependent scaling with LTI models
fitmagfrd	Fit scaling magnitude data with stable, minimum-phase model



## Sampled-Data Systems

adhinfnorm	Induced L2 norm of a sampled-data system
sdlsim	Time response of sampled-data feedback systems
sdhinfosyn	Sample-data $H_\infty$ controller synthesis

## Gain Scheduling

hinfgs	Design gain-scheduled $H_\infty$ controllers
--------	--

## Supporting Utilities

bilin	State-space bilinear transform
mktito	Partition LTI systems by input and output groups
sectf	Sector transformation for LTI systems
skewdec	Create a skew-symmetric matrix (LMI)

## Specification of Systems of LMIs

lmiedit	Open the LMI editor GUI
setlmis	Initialize the creation of LMIs
lmivar	Create a new matrix-valued variable in LMI systems
lmiterm	Add a new term to a given LMI
newlmi	Add a new LMI to an LMI system
getlmis	Get the internal description of LMI systems

## **LMI Characteristics**

<code>lmiinfo</code>	Get information about an existing system of LMIs
<code>lminbr</code>	Get the number of LMIs in an LMI system
<code>matnbr</code>	Get the number of matrix variables in an LMI system
<code>decnbr</code>	Get the number of decision variables in an LMI system
<code>dec2mat</code>	Extract matrix variable value from vector of decision variables
<code>mat2dec</code>	Construct decision variables vector from matrix
<code>decinfo</code>	Show how matrix variables depend on decision variables

## **LMI Solvers**

<code>feasp</code>	compute a solution to a given LMI system
<code>mincx</code>	Minimize a linear objective under LMI constraints
<code>gevp</code>	Solve generalized eigenvalue minimization problems
<code>defcx</code>	Specify $c^x$ objectives of <code>mincx</code>

## **Validation of Results**

<code>evallmi</code>	Evaluate the LMIs for given values of decision variables
<code>showlmi</code>	Return the left- and right-hand-side of evaluated LMIs

## Modification of Systems of LMIs

<code>dellmi</code>	Synthesis of a robust controller via $\mu$ -synthesis
<code>delmvar</code>	Create a <code>dksyn</code> options object
<code>setmvar</code>	Interactive mouse-based sketching and fitting tool

## Functions – Alphabetical List

actual2normalized	10-15
aff2pol	10-18
augw	10-19
balancmr	10-22
bilin	10-27
bstmr	10-32
cmsclsyn	10-37
decay	10-39
decinfo	10-40
decnbr	10-43
dec2mat	10-44
defcx	10-45
dellmi	10-46
delmvar	10-48
diag	10-49
dkitopt	10-50
dksyn	10-54
dmplot	10-63
drawmag	10-67
evallmi	10-69
feasp	10-71
fitfrd	10-75
fitmagfrd	10-78
gapmetric	10-83
genphase	10-87
getlmi	10-88
gevp	10-89
gridureal	10-93
h2hinfosyn	10-97
h2syn	10-99
hankelmr	10-105
hankelsv	10-112
hinfgs	10-115
hinfosyn	10-118
iconnect	10-125

icsignal	10-129
imp2exp	10-130
imp2ss	10-133
ispsys	10-136
isuncertain	10-137
lftdata	10-139
lmiedit	10-145
lmiinfo	10-147
lminbr	10-151
lmireg	10-152
lmiterm	10-153
lmivar	10-156
frd/loglog	10-160
loopmargin	10-162
loopsens	10-173
loopsyn	10-177
ltrsyn	10-183
matnbr	10-187
mat2dec	10-188
mincx	10-190
mixsyn	10-193
mkfilter	10-196
mktito	10-198
modreal	10-200
msfsyn	10-202
mussv	10-204
mussvextract	10-209
ncfmargin	10-214
ncfmr	10-218
ncfsyn	10-222
newlmi	10-226
normalized2actual	10-227
pdlstab	10-228
pdsimul	10-230
polydec	10-231
popov	10-232
psinfo	10-233

psys	10-234
pvec	10-236
pvinfos	10-238
quadperf	10-239
quadstab	10-241
randatom	10-243
randumat	10-245
randuss	10-247
frd/rcond	10-249
reduce	10-250
repmat	10-254
robopt	10-255
robustperf	10-258
robuststab	10-266
frd/schur	10-276
schurmr	10-277
sdhinfnorm	10-282
sdhinfosyn	10-284
sdlsim	10-287
sectf	10-292
frd/semilog	10-297
setlmis	10-298
setmvar	10-299
showlmi	10-301
simplify	10-302
skewdec	10-307
slowfast	10-308
squeeze	10-310
uss/ssbal	10-311
stabproj	10-314
stack	10-316
frd/svd	10-318
symdec	10-319
sysic	10-320
ucomplex	10-323
ucomplexm	10-325
udyn	10-327

---

ufrd .....	10-328
ultidyn .....	10-330
umat .....	10-332
uplot .....	10-334
ureal .....	10-337
usample .....	10-340
uss .....	10-343
usubs .....	10-345
wcgain .....	10-348
wcgopt .....	10-361
wcmargin .....	10-366
wcnorm .....	10-372
wcsens .....	10-378





**Purpose** Calculate the normalized distance between a nominal value and a given value for an uncertain atom

**Syntax** `ndist = actual2normalized(A,V)`

**Description** `ndist = actual2normalized(A,V)` is the normalized distance between the nominal value of the uncertain atom `A` and the given value `V`.

If `V` is an array of values, then `ndist` is an array of normalized distances.

The robustness margins computed in `robuststab` and `robustperf` serve as bounds for the normalized distances in `ndist`. For example, if an uncertain system has a stability margin of 1.4, this system is stable when the normalized distance of the uncertain element values from the nominal is less than 1.4.

**Example** For uncertain real parameters whose range is symmetric about their nominal value, the normalized distance is intuitive.

Create uncertain real parameters with a range that is symmetric about the nominal value, where each end point is 1 unit from the nominal. Points that lie inside the range are less than 1 unit from the nominal, while points that lie outside the range are greater than 1 unit from the nominal.

```
a = ureal('a',3,'range',[1 5]);
actual2normalized(a,[1 3 5])
ans =
    -1.0000    -0.0000     1.0000
actual2normalized(a,[2 4])
ans =
    -0.5000     0.5000
actual2normalized(a,[0 6])
ans =
    -1.5000     1.5000
```

Plot the normalized distance for several values. Note that the relationship between a normalized distance and a numerical difference is linear.

```
values = linspace(-3,9,250);
ndist = actual2normalized(a,values);
```

# actual2normalized

```
plot(values,ndist)
```

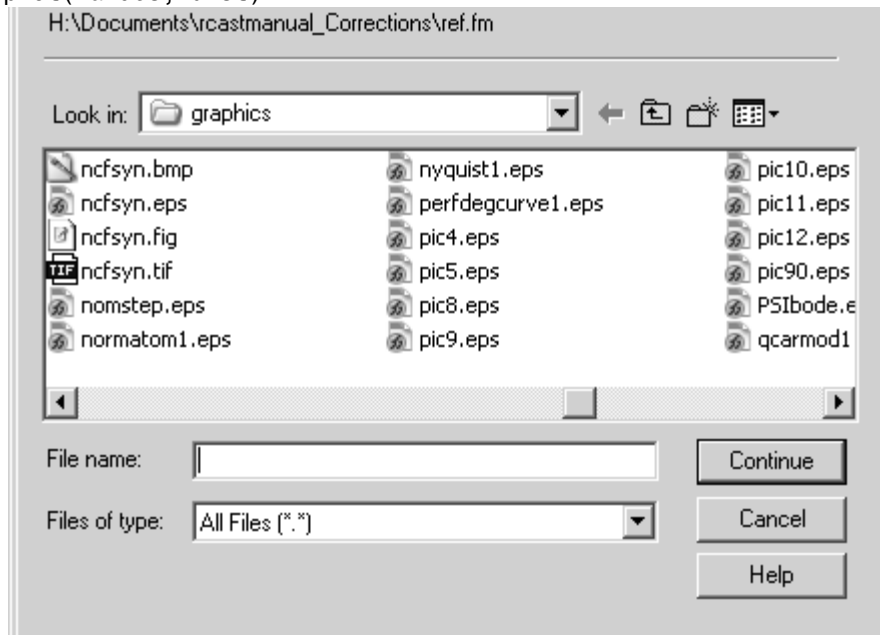

Next, create an asymmetric parameter, where each end point is 1 unit from the nominal. Points that lie inside the range are less than 1 unit from the nominal, while points that lie outside the range are greater than 1 unit from the nominal.

```
au = ureal('a',4,'range',[1 5]);
actual2normalized(a,[1 4 5])
ans =
    -1.0000    0.5000    1.0000
actual2normalized(a,[2 4.5])
ans =
    -0.5000    0.7500
actual2normalized(a,[0 6])
ans =
    -1.5000    1.5000
```

Plot the normalized distance for several values. Note that the relationship between normalized distance and numerical difference is nonlinear.

```

ndistu = actual2normalized(au,values);
plot(values,ndistu)
xlim([-4 10])
ylim([0 4])

```

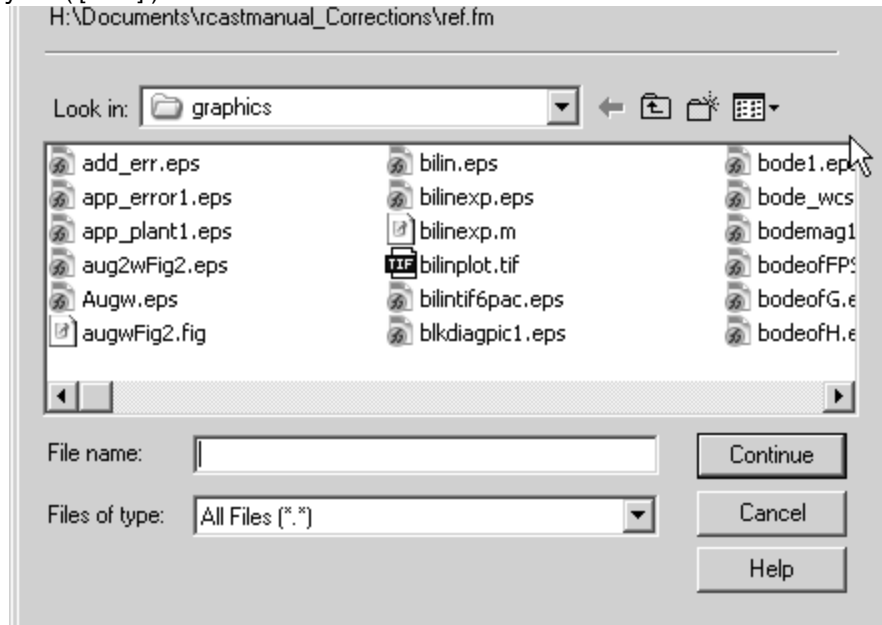

## See Also

robuststab  
robustperf

Calculate robust stability margin  
Calculate robust performance margin

# aff2pol

---

**Purpose** Convert affine parameter-dependent models to polytopic models

**Syntax** `polysys = aff2pol(affsys)`

**Description** `aff2pol` derives a polytopic representation `polysys` of the *affine* parameter-dependent system

$$E(p)\dot{x} = A(p)x + B(p)u \quad (10-1)$$

$$y = C(p)x + D(p)u \quad (10-2)$$

where  $p = (p_1, \dots, p_n)$  is a vector of uncertain or time-varying real parameters taking values in a box or a polytope. The description `affsys` of this system should be specified with `psys`.

The vertex systems of `polysys` are the instances of (9-1)–(9-2) at the vertices  $p_{ex}$  of the parameter range, i.e., the SYSTEM matrices

$$\begin{pmatrix} A(p_{ex}) + jE(p_{ex}) & B(p_{ex}) \\ C(p_{ex}) & D(p_{ex}) \end{pmatrix}$$

for all corners  $p_{ex}$  of the parameter box or all vertices  $p_{ex}$  of the polytope of parameter values.

**See Also**

<code>psys</code>	Specification of uncertain state-space model
<code>pvec</code>	Quantification of uncertainty on physical parameters
<code>uss</code>	Create an uncertain state-space model

**Purpose** State-space or transfer function plant augmentation for use in weighted mixed-sensitivity  $H_\infty$  and  $H_2$  loopshaping design.

**Syntax**  $P = \text{AUGW}(G, W1, W2, W3)$

**Description**  $P = \text{AUGW}(G, W1, W2, W3)$  computes a state-space model of an augmented LTI plant  $P(s)$  with weighting functions  $W_1(s)$ ,  $W_2(s)$ , and  $W_3(s)$  penalizing the error signal, control signal and output signal respectively (see block diagram) so that the closed-loop transfer function matrix is the weighted mixed sensitivity

$$T_{y_1, u_1} \triangleq \begin{bmatrix} W_1 S \\ W_2 R \\ W_3 T \end{bmatrix}$$

where  $S$ ,  $R$  and  $T$  are given by

$$S = (I + GK)^{-1}$$

$$R = K(I + GK)^{-1} \cdot$$

$$T = GK(I + GK)^{-1}$$

The LTI systems  $S$  and  $T$  are called the *sensitivity* and *complementary sensitivity*, respectively.

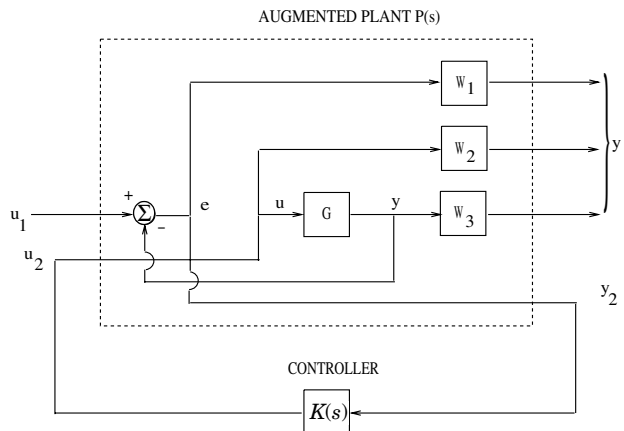

**Figure 10-1: Plant Augmentation.**

For dimensional compatibility, each of the three weights  $W_1$ ,  $W_2$  and  $W_3$  must be either empty, a scalar (SISO) or have respective input dimensions  $N_{Y_1}$ ,  $N_{U_1}$ , and  $N_{Y_2}$  where  $G$  is  $N_{Y_2}$ -by- $N_{U_1}$ . If one of the weights is not needed, you may simply assign an empty matrix  $[\ ]$ ; e.g.,  $P = \text{AUGW}(G, W_1, [\ ], W_3)$  is  $P(s)$  as in the “Algorithm” section below, but without the second row (without the row containing  $W_2$ ).

## Algorithm

The augmented plant  $P(s)$  produced by is

$$P(s) = \left[ \begin{array}{c|c} W_1 & -W_1 G \\ \hline 0 & W_2 \\ 0 & W_3 G \\ \hline I & -G \end{array} \right]$$

with state-space realization

$$P(s) := \left[ \begin{array}{c|c} A & B_1 \quad B_2 \\ \hline C_1 & D_{11} \quad D_{12} \\ \hline C_2 & D_{21} \quad D_{22} \end{array} \right]$$

$$= \left[ \begin{array}{cccc|c|c} A_G & 0 & 0 & 0 & 0 & B_G \\ -B_{W_1} C_G & A_{W_1} & 0 & 0 & B_{W_1} & -B_{W_1} D_G \\ 0 & 0 & A_{W_2} & 0 & 0 & B_{W_2} \\ B_{W_3} C_G & 0 & 0 & A_{W_3} & 0 & B_{W_3} D_G \\ \hline -D_{W_1} D_G & C_{W_1} & 0 & 0 & D_{W_1} & -D_{W_1} D_G \\ 0 & 0 & C_{W_2} & 0 & 0 & D_{W_2} \\ \tilde{C}_G + D_{W_3} C_G & 0 & 0 & C_{W_3} & 0 & \tilde{D}_G + D_{W_3} D_G \\ \hline -C_G & 0 & 0 & 0 & I & -D_G \end{array} \right]$$

Partitioning is embedded via  $P = \text{mktito}(P, N_Y, N_U)$ , which sets the InputGroup and OutputGroup properties of  $P$  as follows

```
[r,c]=size(P);
P.InputGroup = struct('U1',1:c-NU,'U2',c-NU+1:c);
P.OutputGroup = struct('Y1',1:r-NY,'Y2',r-NY+1:r);
```

**Example**

```

s=zpk('s'); G=(s-1)/(s+1);
W1=0.1*(s+100)/(100*s+1); W2=0.1; W3=[];
P=augw(G,W1,W2,W3);
[K,CL,GAM]=hinfosyn(P); [K2,CL2,GAM2]=h2syn(P);
L=G*K; S=inv(1+L); T=1-S;
sigma(S,'k',GAM/W1,'k-.',T,'r',GAM*G/W2,'r-.')
legend('S = 1/(1+L)', 'GAM/W1', 'T=L/(1+L)', 'GAM*G/W2', 2)

```

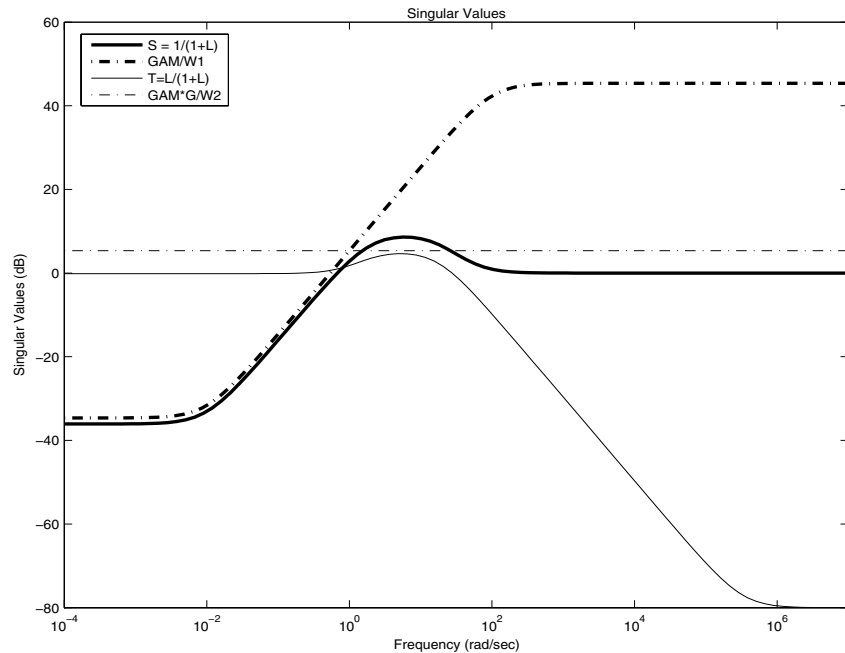
**Limitations**

The transfer functions  $G$ ,  $W_1$ ,  $W_2$  and  $W_3$  must be proper, i.e., bounded as  $s \rightarrow \infty$  or, in the discrete-time case, as  $z \rightarrow \infty$ . Additionally,  $W_1$ ,  $W_2$  and  $W_3$  should be stable. The plant  $G$  should be stabilizable and detectable; else,  $P$  will not be stabilizable by any  $K$ .

**See Also**

h2syn	$H_2$ controller synthesis
hinfosyn	$H_\infty$ controller synthesis
mixsyn	$H_\infty$ mixed-sensitivity controller synthesis
mktito	Partition LTI system via Input and Output Groups

# balancmr

---

**Purpose**                   Balanced model truncation via square root method

**Syntax**

```
GRED = balancmr(G)
GRED = balancmr(G,order)
[GRED,redinfo] = balancmr(G,key1,value1,...)
[GRED,redinfo] = balancmr(G,order,key1,value1,...)
```

**Description**           balancmr returns a reduced order model GRED of G and a struct array redinfo containing the error bound of the reduced model and Hankel singular values of the original system.

The error bound is computed based on Hankel singular values of G. For a stable system these values indicate the respective state energy of the system. Hence, reduced order can be directly determined by examining the system Hankel SV's,  $\sigma$ .

With only one input argument G, the function will show a Hankel singular value plot of the original model and prompt for model order number to reduce.

This method guarantees an error bound on the infinity norm of the *additive error*  $\|G - GRED\|_{\infty}$  for well-conditioned model reduced problems [1]:

$$\|G - Gred\|_{\infty} \leq 2 \sum_{k=1}^n \sigma_k$$

This table describes input arguments for balancmr.

Argument	Description
G	LTI model to be reduced (without any other inputs will plot its Hankel singular values and prompt for reduced order)
ORDER	(Optional) an integer for the desired order of the reduced model, or optionally a vector packed with desired orders for batch runs

A batch run of a serial of different reduced order models can be generated by specifying order = x:y, or a vector of positive integers. By default, all the



anti-stable part of a system is kept, because from control stability point of view, getting rid of unstable state(s) is dangerous to model a system.

'*MaxError*' can be specified in the same fashion as an alternative for 'Order'. In this case, reduced order will be determined when the sum of the tails of the Hankel sv's reaches the '*MaxError*'.

This table lists the input arguments 'key' and its 'value'.

<b>Argument</b>	<b>Value</b>	<b>Description</b>
' <i>MaxError</i> '	Real number or vector of different errors	Reduce to achieve $H_\infty$ error. When present, ' <i>MaxError</i> ' overrides ORDER input.
' <i>Weights</i> '	{Wout,Win} cell array	Optimal 1-by-2 cell array of LTI weights Wout (output) and Win (input). Defaults are both identity. Weights must be invertible.
' <i>Display</i> '	'on' or 'off'	Display Hankel singular plots (default 'off').
' <i>Order</i> '	Integer, vector or cell array	Order of reduced model. Use only if not specified as 2nd argument.

Weights on the original model input and/or output can make the model reduction algorithm focus on some frequency range of interests. But weights have to be stable, minimum phase and invertible.

This table describes output arguments.

Argument	Description
GRED	LTI reduced order model. Becomes multidimensional array when input is a serial of different model order array
REDINFO	A STRUCT array with three fields: <ul style="list-style-type: none"> <li>• REDINFO.ErrorBound (bound on <math>\ G - GRED\ _{\infty}</math>)</li> <li>• REDINFO.StabSV (Hankel SV of stable part of G)</li> <li>• REDINFO.UnstabSV (Hankel SV of unstable part of G)</li> </ul>

G can be stable or unstable, continuous or discrete.

## Algorithm

Given a state space  $(A, B, C, D)$  of a system and  $k$ , the desired reduced order, the following steps will produce a similarity transformation to truncate the original state space system to the  $k^{th}$  order reduced model.

- 1 Find the SVD of the controllability and observability grammians

$$P = U_p \Sigma_p V_p^T$$

$$Q = U_q \Sigma_q V_q^T$$

- 2 Find the square root of the grammians (left/right eigenvectors)

$$L_p = U_p \Sigma_p^{1/2}$$

$$L_o = U_q \Sigma_q^{1/2}$$

- 3 Find the SVD of  $(L_o^T L_p)$

$$L_o^T L_p = U \Sigma V^T$$

- 4 Then the left and right transformation for the final  $k^{th}$  order reduced model is

$$S_{L,BIG} = L_o U(:, 1:k) \Sigma(1:k, 1:k)^{-1/2}$$

$$S_{R,BIG} = L_p V(:, 1:k) \Sigma(1:k, 1:k)^{-1/2}$$

5 Finally,

$$\begin{bmatrix} \hat{A} & \hat{B} \\ \hat{C} & \hat{D} \end{bmatrix} = \begin{bmatrix} S_{L,BIG}^T A S_{R,BIG} & S_{L,BIG}^T B \\ C S_{R,BIG} & D \end{bmatrix}$$

The proof of the square root balance truncation algorithm can be found in [2].

### Example

Given a continuous or discrete, stable or unstable system, G, the following commands can get a set of reduced order models based on your selections:

```
rand('state',1234); randn('state',5678);G = rss(30,5,4);
[g1, redinfo1] = balancmr(G); % display Hankel SV plot
                        % and prompt for order (try 15:20)
[g2, redinfo2] = balancmr(G,20);
[g3, redinfo3] = balancmr(G,[10:2:18]);
[g4, redinfo4] = balancmr(G,'MaxError',[0.01, 0.05]);
rand('state',12345); randn('state',6789);
wt1 = rss(6,5,5); wt1.d = eye(5)*2;
wt2 = rss(6,4,4); wt2.d = 2*eye(4);
[g5, redinfo5] = balancmr(G, [10:2:18], 'weight',{wt1,wt2});
for i = 1:5
    figure(i); eval(['sigma(G,g' num2str(i) ');']);
end
```

### Reference

- [1] Glover, K. "All Optimal Hankel Norm Approximation of Linear Multivariable Systems, and Their  $L_\mu$  - error Bounds," *Int. J. Control*, vol. 39, no. 6, pp. 1145-1193, 1984.
- [2] Safonov M.G. and R. Y. Chiang, "A Schur Method for Balanced Model Reduction," *IEEE Trans. on Automat. Contr.*, vol. 34, no. 7, July 1989, pp. 729-733.

### See Also

reduce	Top level model reduction function
schurmr	Balanced model truncation via Schur method
hankelmr	Hankel minimum degree approximation
bstmr	Balanced stochastic model truncation via Schur method
ncfmr	Balanced model truncation for normalized coprime factors

# balancmr

---

hanke1sv

Hankel singular values

**Purpose** Multivariable bilinear transform of frequency ( $s$  or  $z$ ).

**Syntax** `GT = bilin(G,VERS,METHOD,AUG)`

**Description** `bilin` computes the effect on a system of the frequency-variable substitution,

$$s = \frac{\alpha z + \delta}{\gamma z + \beta}$$

The variable `VERS` denotes the transformation direction:

`VERS= 1`, forward transform ( $s \rightarrow z$ ) or ( $s \rightarrow \tilde{s}$ ).

`VERS=-1`, reverse transform ( $z \rightarrow s$ ) or ( $s \rightarrow \tilde{s}$ ).

This transformation maps lines and circles to circles and lines in the complex plane. People often use this transformation to do sampled-data control system design [1] or, in general, to do shifting of  $j\omega$  modes [2], [3], [4].

`Bilin` computes several state-space bilinear transformations such as backward rectangular, etc., based on the `METHOD` you select

**Table 10-1: Bilinear transform types.**

Method	Type of bilinear transform
'BwdRec'	backward rectangular: $s = \frac{z-1}{Tz}$ <code>AUG = T</code> , the sampling period.
'FwdRec'	forward rectangular: $s = \frac{z-1}{T}$ <code>AUG = T</code> , the sampling period.

**Table 10-1: Bilinear transform types.**

Method	Type of bilinear transform
'S_Tust'	shifted Tustin: $s = \frac{2}{T} \left( \frac{z-1}{\frac{z}{h} + 1} \right)$ AUG = [T h], is the “shift” coefficient.
'S_ftjw'	shifted $j\omega$ -axis, bilinear pole-shifting, continuous-time to continuous-time: $s = \frac{\tilde{s} + p_1}{1 + \tilde{s}/p_2}$ AUG = [ $p_2 p_1$ ].
'G_Bilin'	METHOD = 'G_Bilin', general bilinear, continuous-time to continuous-time: $s = \frac{\alpha \tilde{s} + \delta}{\gamma \tilde{s} + \beta}$ AUG = [ $\alpha \beta \gamma \delta$ ].

## Example

**Example 1.** Tustin continuous  $s$ -plane to discrete  $z$ -plane transforms.

Consider the following continuous-time plant (sampled at 20 Hz)

$$A = \begin{bmatrix} -1 & 1 \\ 0 & -2 \end{bmatrix}, \quad B = \begin{bmatrix} 1 & 0 \\ 1 & 1 \end{bmatrix}, \quad C = \begin{bmatrix} 1 & 0 \\ 0 & 1 \end{bmatrix}, \quad D = \begin{bmatrix} 0 & 0 \\ 0 & 0 \end{bmatrix}; \quad T_s = 0.05$$

Following is an example of four common “continuous to discrete” bilin transformations for the sampled plant:

```

A= [-1 1; 0 -2]; B=[1 0; 1 1];
C= [1 0; 0 1]; D=[0 0; 0 0];
sys = ss(A,B,C,D); % ANALOG
Ts=0.05; % sampling time
[syst] = c2d(sys,Ts,'tustin'); % Tustin

```

```
[sysp] = c2d(sys,Ts,'prewarp',40);           % Pre-warped Tustin
[sysb] = bilin(sys,1,'BwdRec',Ts);         % Backward Rectangular
[sysf] = bilin(sys,1,'FwdRec',Ts);        % Forward Rectangular
w = logspace(-2,3,50); % frequencies to plot
sigma(sys,syst,sysp,sysb,sysf,w);
```

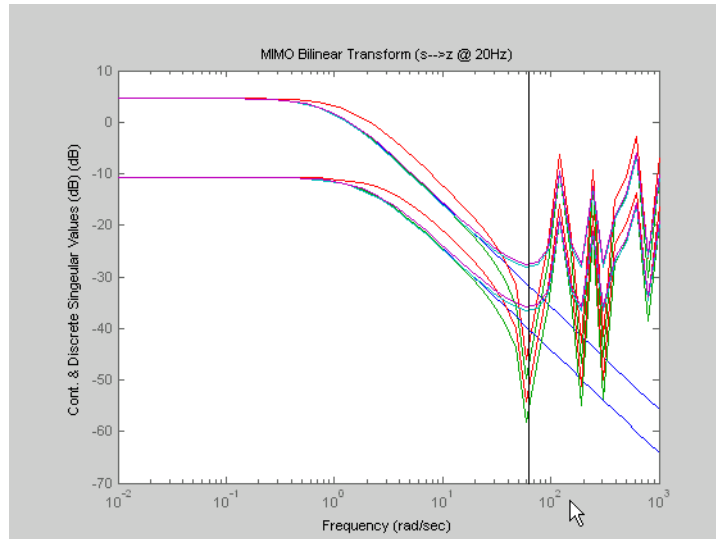

**Figure 10-2: . Comparison of 4 Bilinear Transforms from Example 1.**

**Example 2. Bilinear continuous to continuous pole-shifting 'S\_ftjw'**

Design an H mixed-sensitivity controller for the ACC Benchmark plant

$$G(s) = \frac{1}{s^2(s^2 + 2)}$$

such that all closed-loop poles lie inside a circle in the left half of the s-plane whose diameter lies on between points [p1,p2]=[-12,-2]:

```
p1=-12; p2=-2; s=zpk('s');
G=ss(1/(s^2*(s^2+2))); % original unshifted plant
Gt=bilin(G,1,'Sft_jw',[p1 p2]); % bilinear pole shifted plant Gt
Kt=mixsyn(Gt,1,[],1); % bilinear pole shifted controller
K =bilin(Kt,-1,'Sft_jw',[p1 p2]); % final controller K
```

As shown in Figure 10-3, closed-loop poles are placed in the left circle [p1 p2]. The shifted plant, which has its non-stable poles shifted to the inside the right circle, is

$$G_t(s) = 4.765 \times 10^{-5} \frac{(s - 12)^4}{(s - 2)^2 (s^2 - 4.274s + 5.918)}$$

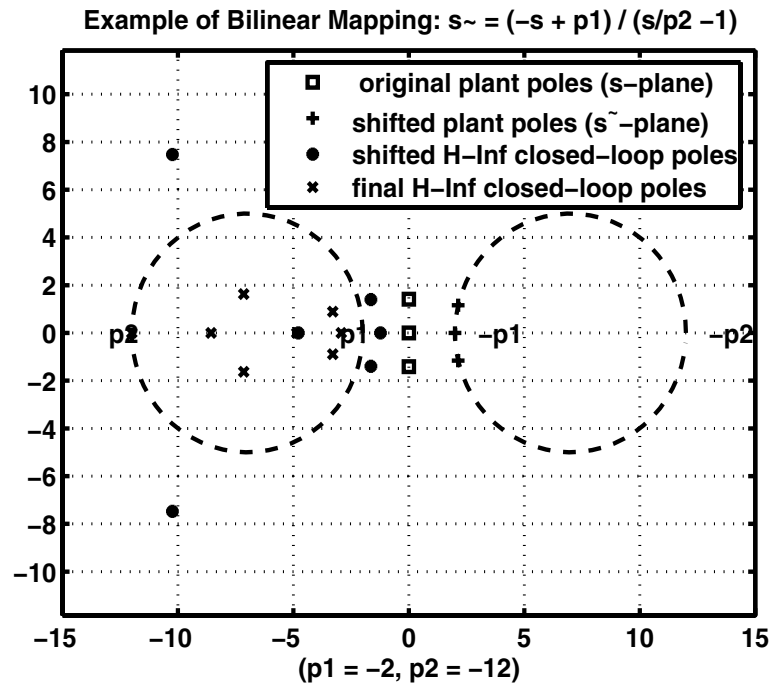

**Figure 10-3:** 's\_ftjw' final closed-loop poles are inside the left [p1,p2] circle.

## Algorithm

bilin employs the state-space formulae in [3]:

$$\left[ \begin{array}{c|c} A_b & B_b \\ \hline C_b & D_b \end{array} \right] = \left[ \begin{array}{c|c} (\beta A - \delta I)(\alpha I + \gamma A)^{-1} & (\alpha \beta - \gamma \delta)(\alpha I - \gamma A)^{-1} B \\ \hline C(\alpha I - \gamma A)^{-1} & D + \gamma C(\alpha I - \gamma A)^{-1} B \end{array} \right]$$



**References**

- [1] Franklin, G. F., and J. D. Powell, *Digital Control of Dynamics System*, Addison-Wesley, 1980.
- [2] Safonov, M. G., R. Y. Chiang and H. Flashner, “ $H_\infty$  Control Synthesis for a Large Space Structure,” *AIAA J. Guidance, Control and Dynamics*, 14, 3, pp. 513-520, May/June 1991.
- [3] Safonov, M. G., “Imaginary-Axis Zeros in Multivariable  $H_\infty$  Optimal Control”, in R. F. Curtain (editor), *Modelling, Robustness and Sensitivity Reduction in Control Systems*, pp. 71-81, Springer-Varlet, Berlin, 1987.
- [4] Chiang, R. Y. and M. G. Safonov, “ $H_\infty$  Synthesis using a Bilinear Pole Shifting Transform,” *AIAA, J. Guidance, Control and Dynamics*, vol. 15, no. 5, pp. 1111-1117, September–October 1992.

**See Also**

- |       |  |
|-------|--|
| c2d   | Convert from continous- to discrete-time |
| d2c   | Convert from continous- to discrete-time |
| sectf | Sector transformation                    |

# bstmr

---

**Purpose** Balanced stochastic model truncation (BST) via Schur method

**Syntax**

```
GRED = bstmr(G)
GRED = bstmr(G,order)
[GRED,redinfo] = bstmr(G,key1,value1,...)
[GRED,redinfo] = bstmr(G,order,key1,value1,...)
```

**Description** bstmr returns a reduced order model GRED of G and a struct array redinfo containing the error bound of the reduced model and Hankel singular values of the *phase matrix* of the original system [2].

The error bound is computed based on Hankel singular values of the phase matrix of G. For a stable system these values indicate the respective state energy of the system. Hence, reduced order can be directly determined by examining these values.

With only one input argument G, the function will show a Hankel singular value plot of the phase matrix of G and prompt for model order number to reduce.

This method guarantees an error bound on the infinity norm of the *multiplicative*  $\|GRED^{-1}(G-GRED)\|_{\infty}$  or *relative error*  $\|G^{-1}(G-GRED)\|_{\infty}$  for well-conditioned model reduction problems [1]:

$$\|G^{-1}(G-Gred)\|_{\infty} \leq \prod_{k=1}^n (1 + 2\sigma_i(\sqrt{1 + \sigma_i^2} + \sigma_i)) - 1$$

This table describes input arguments for bstmr.

Argument	Description
G	LTI model to be reduced (without any other inputs will plot its Hankel singular values and prompt for reduced order)
ORDER	(Optional) an integer for the desired order of the reduced model, or a vector of desired orders for batch runs

A batch run of a serial of different reduced order models can be generated by specifying order = x:y, or a vector of integers. By default, all the anti-stable

part of a system is kept, because from control stability point of view, getting rid of unstable state(s) is dangerous to model a system.

'MaxError' can be specified in the same fashion as an alternative for 'ORDER'. In this case, reduced order will be determined when the accumulated product of Hankel SVs shown in the above equation reaches the 'MaxError'.

Argument	Value	Description
'MaxError'	Real number or vector of different errors	Reduce to achieve $H_\infty$ error. When present, 'MaxError' overrides ORDER input.
'Display'	'on' or 'off'	Display Hankel singular plots (default 'off').
'Order'	Integer, vector or cell array	Order of reduced model. Use only if not specified as 2nd argument.

This table describes output arguments.

Argument	Description
GRED	LTI reduced order model. Become multi-dimension array when input is a serial of different model order array.
REDINFO	A STRUCT array with three fields: <ul style="list-style-type: none"> <li>• REDINFO.ErrorBound (bound on <math>\ G^{-1}(G-GRED)\ _\infty</math>)</li> <li>• REDINFO.StabSV (Hankel SV of stable part of G)</li> <li>• REDINFO.UnstabSV (Hankel SV of unstable part of G)</li> </ul>

G can be stable or unstable, continuous or discrete.

## Algorithm

Given a state space  $(A,B,C,D)$  of a system and  $k$ , the desired reduced order, the following steps will produce a similarity transformation to truncate the original state space system to the  $k^{th}$  order reduced model.

- 1** Find the controllability grammian  $P$  and observability grammian  $Q$  of the left *spectral factor*  $\Phi = \Gamma(\sigma)\Gamma^*(-\sigma) = \Omega^*(-\sigma)\Omega(\sigma)$  by solving the following Lyapunov and Riccati equations

$$AP + PA^T + BB^T = 0$$

$$B_W = PC^T + BD^T$$

$$QA + A^T Q + (QB_W - C^T) (-DD^T) (QB_W - C^T)^T = 0$$

- 2** Find the Schur decomposition for  $PQ$  in both ascending and descending order, respectively,

$$V_A^T P Q V_A = \begin{bmatrix} \lambda_1 & \dots & \dots \\ 0 & \dots & \dots \\ 0 & 0 & \lambda_n \end{bmatrix}$$

$$V_D^T P Q V_D = \begin{bmatrix} \lambda_n & \dots & \dots \\ 0 & \dots & \dots \\ 0 & 0 & \lambda_1 \end{bmatrix}$$

- 3** Find the left/right orthonormal eigen-bases of  $PQ$  associated with the  $k^{th}$  big Hankel singular values of the all-pass *phase matrix*  $(W^*(s))^{-1}G(s)$ .

$$V_A = [V_{R,SMALL}, \overbrace{V_{L,BIG}}^k]$$

$$V_D = [\overbrace{V_{R,BIG}}^k, V_{L,SMALL}]$$

- 4** Find the SVD of  $(V_{L,BIG}^T V_{R,BIG}) = U \Sigma \zeta^T$   
**5** Form the left/right transformation for the final  $k^{th}$  order reduced model

$$S_{L,BIG} = V_{L,BIG} U \Sigma(1:k, 1:k)^{-1/2}$$

$$S_{R,BIG} = V_{R,BIG} \zeta \Sigma(1:k, 1:k)^{-1/2}$$

6 Finally,

$$\left[ \begin{array}{c|c} \hat{A} & \hat{B} \\ \hline \hat{C} & \hat{D} \end{array} \right] = \left[ \begin{array}{c|c} S^T_{L,BIG} A S_{R,BIG} & S^T_{L,BIG} B \\ \hline C S_{R,BIG} & D \end{array} \right]$$

The proof of the Schur BST algorithm can be found in [2].

---

**Note** The BST model reduction theory requires that the original model  $D$  matrix be full rank, for otherwise the Riccati solver fails. For any problem with strictly proper model, you can shift the  $j\omega$ -axis via `bilin` such that BST/REM approximation can be achieved up to a particular frequency range of interests. Alternatively, you can attach a small but full rank  $D$  matrix to the original problem but remove the  $D$  matrix of the reduced order model afterwards. As long as the size of  $D$  matrix is insignificant inside the control bandwidth, the reduced order model should be fairly close to the true model. By default, the `bstmr` program will assign a full rank  $D$  matrix scaled by 0.001 of the minimum eigenvalue of the original model, if its  $D$  matrix is not full rank to begin with. This serves the purpose for most problems if user does not want to go through the trouble of model pretransformation.

---

## Example

Given a continuous or discrete, stable or unstable system,  $G$ , the following commands can get a set of reduced order models based on your selections:

```
rand('state',1234); randn('state',5678);
G = rss(30,5,4); G.d = zeros(5,4);
[g1, redinfo1] = bstmr(G); % display Hankel SV plot
                        % and prompt for order (try 15:20)
[g2, redinfo2] = bstmr(G,20);
[g3, redinfo3] = bstmr(G,[10:2:18]);
[g4, redinfo4] = bstmr(G,'MaxError',[0.01, 0.05]);
for i = 1:4
    figure(i); eval(['sigma(G,g' num2str(i) ');']);
end
```

## Reference

[1] Zhou K. "Frequency weighted  $L_2$  error bounds," Syst. Contr. Lett., Vol. 21, 115-125, 1993.

[2] Safonov M. G. and R. Y. Chiang, "Model Reduction for Robust Control: A Schur Relative Error Method," *International J. of Adaptive Control and Signal Processing*, Vol. 2, pp. 259-272, 1988.

## See Also

reduce	Top level model reduction function
balancmr	Balanced truncation via square-root method
hankelmr	Hankel minimum degree approximation
schurmr	Balanced truncation via Schur method
ncfmr	Balanced truncation for normalized coprime factors
hankelsv	Hankel singular value

- Purpose** Approximately solves the constant-matrix, upper bound  $\mu$ -synthesis problem
- Syntax**
- ```
[qopt,bnd] = cmsclsyn(R,U,V,BlockStructure);
[qopt,bnd] = cmsclsyn(R,U,V,BlockStructure,opt);
[qopt,bnd] = cmsclsyn(R,U,V,BlockStructure,opt,qinit);
[qopt,bnd] = cmsclsyn(R,U,V,BlockStructure,opt,'random',N)
```
- Description** cmsclsyn approximately solves the constant-matrix, upper bound  $\mu$ -synthesis problem by minimization

$$\min_{Q \in C^{r \times t}} \mu_{\Delta}(R + UQV)$$

for given matrices  $R \in C^{n \times m}$ ,  $U \in C^{n \times r}$ ,  $V \in C^{t \times m}$ , and a set  $\Delta \subset C^{m \times n}$ . This applies to constant matrix data in  $R$ ,  $U$ , and  $V$ .

[QOPT,BND] = cmsclsyn(R,U,V,BlockStructure) minimizes, by choice of  $Q$ , QOPT is the optimum value of  $Q$ , the upper bound of  $\text{mussv}(R+U*Q*V, \text{BLK})$ , BND. The matrices  $R,U$  and  $V$  are constant matrices of the appropriate dimension. BlockStructure is a matrix specifying the perturbation blockstructure as defined for mussv.

[QOPT,BND] = cmsclsyn(R,U,V,BlockStructure,OPT) uses the options specified by OPT in the calls to mussv. See mussv for more information. The default value for OPT is 'cUsw'.

[QOPT,BND] = cmsclsyn(R,U,V,BlockStructure,OPT,QINIT) initializes the iterative computation from  $Q = QINIT$ . Due to the nonconvexity of the overall problem, different starting points often yield different final answers. If QINIT is an N-D array, then the iterative computation is performed multiple times - the  $i$ 'th optimization is initialized at  $Q = QINIT(:, :, i)$ . The output arguments are associated with the best solution obtained in this brute force approach.

[QOPT,BND] = cmsclsyn(R,U,V,BlockStructure,OPT,'random',N) initializes the iterative computation from N random instances of QINIT. If NCU is the number of columns of U, and NRV is the number of rows of V, then the approximation to solving the constant matrix  $\mu$  synthesis problem is two-fold: only the upper bound for  $\mu$  is minimized, and the minimization is not convex, hence the optimum is generally not found. If U is full column rank, or V is full

row rank, then the problem can (and is) cast as a convex problem, [PacZPB], and the global optimizer (for the upper bound for  $\mu$ ) is calculated.

## Algorithm

The `cmsclsyn` algorithm is iterative, alternatively holding  $Q$  fixed, and computing the `mussv` upper bound, followed by holding the upper bound multipliers fixed, and minimizing the bound implied by choice of  $Q$ . If  $U$  or  $V$  is square and invertible, then the optimizations reformulated (exactly) as an linear matrix inequality, and solved directly, without resorting to the iteration.

## See Also

|                         |                                                           |
|-------------------------|-----------------------------------------------------------|
| <code>dksyn</code>      | Synthesize a robust controller via D-K iteration          |
| <code>hinfsv</code>     | Synthesize a $H_\infty$ controller                        |
| <code>mussv</code>      | Calculate bounds on the Structured Singular Value ( $m$ ) |
| <code>robuststab</code> | Calculate stability margins of uncertain systems          |
| <code>robustperf</code> | Calculate performance margins of uncertain systems        |

## Reference

Packard, A.K., K. Zhou, P. Pandey, and G. Becker, "A collection of robust control problems leading to LMI's," *30th IEEE Conference on Decision and Control*, pp. 1245–1250, Brighton, UK, 1991.



**Purpose** Quadratic decay rate of polytopic or affine P-systems

**Syntax** [drate,P] = decay(ps,options)

**Description** For affine parameter-dependent systems

$$E(p)\dot{x} = A(p)x, \quad p(t) = (p_1(t), \dots, p_n(t))$$

or polytopic systems

$$E(t)\dot{x} = A(t)x, \quad (A, E) \in \text{Co}\{(A_1, E_1), \dots, (A_n, E_n)\},$$

decay returns the quadratic decay rate drate, i.e., the smallest  $\alpha \in \mathbf{R}$  such that

$$A^T Q E + E Q A^T < \alpha Q$$

holds for some Lyapunov matrix  $Q > 0$  and all possible values of  $(A, E)$ . Two control parameters can be reset via options(1) and options(2):

- If options(1)=0 (default), decay runs in fast mode, using the least expensive sufficient conditions. Set options(1)=1 to use the least conservative conditions.
- options(2) is a bound on the condition number of the Lyapunov matrix  $P$ . The default is  $10^9$ .

## See Also

|          |                                                                                |
|----------|--------------------------------------------------------------------------------|
| quadstab | Quadratic stability of polytopic or parameter-dependent systems                |
| pdlstab  | Robust stability of polytopic or affine parameter-dependent systems (P-system) |
| psys     | Specification of uncertain state-space models                                  |

# decinfo

---

**Purpose** Describe how the entries of a matrix variable  $X$  relate to the decision variables

**Syntax**  
`decinfo(lmisys)`  
`decX = decinfo(lmisys,X)`

**Description** The function `decinfo` expresses the entries of a matrix variable  $X$  in terms of the decision variables  $x_1, \dots, x_N$ . Recall that the decision variables are the free scalar variables of the problem, or equivalently, the free entries of all matrix variables described in `lmisys`. Each entry of  $X$  is either a hard zero, some decision variable  $x_n$ , or its opposite  $-x_n$ .

If  $X$  is the identifier of  $X$  supplied by `lmivar`, the command

```
decX = decinfo(lmisys,X)
```

returns an integer matrix `decX` of the same dimensions as  $X$  whose  $(i, j)$  entry is

- 0 if  $X(i, j)$  is a hard zero
- $n$  if  $X(i, j) = x_n$  (the  $n$ -th decision variable)
- $-n$  if  $X(i, j) = -x_n$

`decX` clarifies the structure of  $X$  as well as its entry-wise dependence on  $x_1, \dots, x_N$ . This is useful to specify matrix variables with atypical structures (see `lmivar`).

`decinfo` can also be used in interactive mode by invoking it with a single argument. It then prompts the user for a matrix variable and displays in return the decision variable content of this variable.

**Example 1** Consider an LMI with two matrix variables  $X$  and  $Y$  with structure:

- $X = x I_3$  with  $x$  scalar
- $Y$  rectangular of size 2-by-1

If these variables are defined by

```
setlmis([])  
X = lmivar(1,[3 0])  
Y = lmivar(2,[2 1])  
:  
:  
lmis = getlmis
```

the decision variables in  $X$  and  $Y$  are given by

```
dX = decinfo(lmis,X)
```

```
dX =
    1    0    0
    0    1    0
    0    0    1
```

```
dY = decinfo(lmis,Y)
```

```
dY =
    2
    3
```

This indicates a total of three decision variables  $x_1, x_2, x_3$  that are related to the entries of  $X$  and  $Y$  by

$$X = \begin{pmatrix} x_1 & 0 & 0 \\ 0 & x_1 & 0 \\ 0 & 0 & x_1 \end{pmatrix}, \quad Y = \begin{pmatrix} x_2 \\ x_3 \end{pmatrix}$$

Note that the number of decision variables corresponds to the number of free entries in  $X$  and  $Y$  when taking structure into account.

## Example 2

Suppose that the matrix variable  $X$  is symmetric block diagonal with one 2-by-2 full block and one 2-by-2 scalar block, and is declared by

```
setlmis([])
X = lmivar(1,[2 1;2 0])
:
lmis = getlmis
```

The decision variable distribution in  $X$  can be visualized interactively as follows:

```
decinfo(lmis)
```

There are 4 decision variables labeled  $x_1$  to  $x_4$  in this problem.

Matrix variable Xk of interest (enter k between 1 and 1, or 0 to quit):

?> 1

The decision variables involved in X1 are among  $\{-x_1, \dots, x_4\}$ .  
Their entry-wise distribution in X1 is as follows  
(0, j>0, -j<0 stand for 0, xj, -xj, respectively):

X1 :

|   |   |   |   |
|---|---|---|---|
| 1 | 2 | 0 | 0 |
| 2 | 3 | 0 | 0 |
| 0 | 0 | 4 | 0 |
| 0 | 0 | 0 | 4 |

\*\*\*\*\*

Matrix variable Xk of interest (enter k between 1 and 1, or 0 to quit):

?> 0

## See Also

|         |                                                                                                    |
|---------|----------------------------------------------------------------------------------------------------|
| lmivar  | Specify the matrix variables in an LMI problem                                                     |
| mat2dec | Return the vector of decision variables corresponding to particular values of the matrix variables |
| dec2mat | Given values of the decision variables, derive the corresponding values of the matrix variables    |

|                      |                                                                                                                                                                                                                                                                                                                                                                                                                                                                                                                                                                                          |                      |                                                                                                                     |                      |                                                                                    |                      |                                                                                                    |
|----------------------|------------------------------------------------------------------------------------------------------------------------------------------------------------------------------------------------------------------------------------------------------------------------------------------------------------------------------------------------------------------------------------------------------------------------------------------------------------------------------------------------------------------------------------------------------------------------------------------|----------------------|---------------------------------------------------------------------------------------------------------------------|----------------------|------------------------------------------------------------------------------------|----------------------|----------------------------------------------------------------------------------------------------|
| <b>Purpose</b>       | Give the total number of decision variables in a system of LMIs                                                                                                                                                                                                                                                                                                                                                                                                                                                                                                                          |                      |                                                                                                                     |                      |                                                                                    |                      |                                                                                                    |
| <b>Syntax</b>        | <code>ndec = decnbr(lmisys)</code>                                                                                                                                                                                                                                                                                                                                                                                                                                                                                                                                                       |                      |                                                                                                                     |                      |                                                                                    |                      |                                                                                                    |
| <b>Description</b>   | The function <code>decnbr</code> returns the number <code>ndec</code> of decision variables (free scalar variables) in the LMI problem described in <code>lmisys</code> . In other words, <code>ndec</code> is the length of the vector of decision variables.                                                                                                                                                                                                                                                                                                                           |                      |                                                                                                                     |                      |                                                                                    |                      |                                                                                                    |
| <b>Example</b>       | <p>For an LMI system <code>lmis</code> with two matrix variables <math>X</math> and <math>Y</math> such that</p> <ul style="list-style-type: none"> <li>• <math>X</math> is symmetric block diagonal with one 2-by-2 full block, and one 2-by-2 scalar block</li> <li>• <math>Y</math> is 2-by-3 rectangular,</li> </ul> <p>the number of decision variables is</p> <pre>ndec = decnbr(LMIs)  ndec =     10</pre> <p>This is exactly the number of free entries in <math>X</math> and <math>Y</math> when taking structure into account (see <code>decinfo</code> for more details).</p> |                      |                                                                                                                     |                      |                                                                                    |                      |                                                                                                    |
| <b>See Also</b>      | <table> <tr> <td><code>dec2mat</code></td> <td>Given values of the decision variables, derive the corresponding values of the matrix variables <code>decnbr</code></td> </tr> <tr> <td><code>decinfo</code></td> <td>Describe how the entries of a matrix variable <math>X</math> relate to the decision variables</td> </tr> <tr> <td><code>mat2dec</code></td> <td>Return the vector of decision variables corresponding to particular values of the matrix variables</td> </tr> </table>                                                                                              | <code>dec2mat</code> | Given values of the decision variables, derive the corresponding values of the matrix variables <code>decnbr</code> | <code>decinfo</code> | Describe how the entries of a matrix variable $X$ relate to the decision variables | <code>mat2dec</code> | Return the vector of decision variables corresponding to particular values of the matrix variables |
| <code>dec2mat</code> | Given values of the decision variables, derive the corresponding values of the matrix variables <code>decnbr</code>                                                                                                                                                                                                                                                                                                                                                                                                                                                                      |                      |                                                                                                                     |                      |                                                                                    |                      |                                                                                                    |
| <code>decinfo</code> | Describe how the entries of a matrix variable $X$ relate to the decision variables                                                                                                                                                                                                                                                                                                                                                                                                                                                                                                       |                      |                                                                                                                     |                      |                                                                                    |                      |                                                                                                    |
| <code>mat2dec</code> | Return the vector of decision variables corresponding to particular values of the matrix variables                                                                                                                                                                                                                                                                                                                                                                                                                                                                                       |                      |                                                                                                                     |                      |                                                                                    |                      |                                                                                                    |

# dec2mat

---

**Purpose** Given values of the decision variables, derive the corresponding values of the matrix variables

**Syntax** `valX = dec2mat(lmisys,decvars,X)`

**Description** Given a value `decvars` of the vector of decision variables, `dec2mat` computes the corresponding value `valX` of the matrix variable with identifier `X`. This identifier is returned by `lmivar` when declaring the matrix variable.

Recall that the decision variables are all free scalar variables in the LMI problem and correspond to the free entries of the matrix variables  $X_1, \dots, X_K$ . Since LMI solvers return a feasible or optimal value of the vector of decision variables, `dec2mat` is useful to derive the corresponding feasible or optimal values of the matrix variables.

**Example** See the description of `feasp`.

**See Also**

|                      |                                                                                                    |
|----------------------|----------------------------------------------------------------------------------------------------|
| <code>mat2dec</code> | Return the vector of decision variables corresponding to particular values of the matrix variables |
| <code>decnbr</code>  | Give the total number of decision variables in a system of LMIs                                    |
| <code>decinfo</code> | Describe how the entries of a matrix variable <code>X</code> relate to the decision variables      |

---

|                    |                                                                                                                                                                                                                                                                                                                                                                                                                        |       |                                                   |         |                                                                                  |
|--------------------|------------------------------------------------------------------------------------------------------------------------------------------------------------------------------------------------------------------------------------------------------------------------------------------------------------------------------------------------------------------------------------------------------------------------|-------|---------------------------------------------------|---------|----------------------------------------------------------------------------------|
| <b>Purpose</b>     | Help specify $c^T x$ objectives for the mincx solver                                                                                                                                                                                                                                                                                                                                                                   |       |                                                   |         |                                                                                  |
| <b>Syntax</b>      | <code>[V1,...,Vk] = defcx(lmisys,n,X1,...,Xk)</code>                                                                                                                                                                                                                                                                                                                                                                   |       |                                                   |         |                                                                                  |
| <b>Description</b> | <p>defcx is useful to derive the <math>c</math> vector needed by mincx when the objective is expressed in terms of the matrix variables.</p> <p>Given the identifiers <math>X_1, \dots, X_k</math> of the matrix variables involved in this objective, defcx returns the values <math>V_1, \dots, V_k</math> of these variables when the <math>n</math>-th decision variable is set to one and all others to zero.</p> |       |                                                   |         |                                                                                  |
| <b>See Also</b>    | <table><tr><td>mincx</td><td>Minimize a linear objective under LMI constraints</td></tr><tr><td>decinfo</td><td>Describe how the entries of a matrix variable X relate to the decision variables</td></tr></table>                                                                                                                                                                                                     | mincx | Minimize a linear objective under LMI constraints | decinfo | Describe how the entries of a matrix variable X relate to the decision variables |
| mincx              | Minimize a linear objective under LMI constraints                                                                                                                                                                                                                                                                                                                                                                      |       |                                                   |         |                                                                                  |
| decinfo            | Describe how the entries of a matrix variable X relate to the decision variables                                                                                                                                                                                                                                                                                                                                       |       |                                                   |         |                                                                                  |

# dellmi

---

**Purpose** Remove an LMI from a given system of LMIs

**Syntax** `newsys = dellmi(lmisys,n)`

**Description** `dellmi` deletes the  $n$ -th LMI from the system of LMIs described in `lmisys`. The updated system is returned in `newsys`.

The ranking  $n$  is relative to the order in which the LMIs were declared and corresponds to the identifier returned by `newlmi`. Since this ranking is not modified by deletions, it is safer to refer to the remaining LMIs by their identifiers. Finally, matrix variables that only appeared in the deleted LMI are removed from the problem.

**Example** Suppose that the three LMIs

$$A_1^T X_1 + X_1 A_1 + Q_1 < 0$$

$$A_2^T X_2 + X_2 A_2 + Q_2 < 0$$

$$A_3^T X_3 + X_3 A_3 + Q_3 < 0$$

have been declared in this order, labeled LMI1, LMI2, LMI3 with `newlmi`, and stored in `lmisys`. To delete the second LMI, type

```
lmis = dellmi(lmisys,LMI2)
```

`lmis` now describes the system of LMIs

$$A_1^T X_1 + X_1 A_1 + Q_1 < 0 \tag{10-3}$$

$$A_3^T X_3 + X_3 A_3 + Q_3 < 0 \tag{10-4}$$

and the second variable  $X_2$  has been removed from the problem since it no longer appears in the system (9-4)–(9-5).

To further delete (9-5), type

```
lmis = dellmi(lmis,LMI3)
```

or equivalently

```
lmis = dellmi(lmis,3)
```



---

Note that (9-5) has retained its original ranking after the first deletion.

**See Also**

|                      |                                                                                 |
|----------------------|---------------------------------------------------------------------------------|
| <code>newlmi</code>  | Attach an identifying tag to LMIs                                               |
| <code>lmiedit</code> | Specify or display systems of LMIs as MATLAB expressions                        |
| <code>lmiinfo</code> | Interactively retrieve information about the variables and term content of LMIs |

# delmvar

---

**Purpose** Delete one of the matrix variables of an LMI problem

**Syntax** `newsys = delmvar(lmisys,X)`

**Description** `delmvar` removes the matrix variable  $X$  with identifier  $X$  from the list of variables defined in `lmisys`. The identifier  $X$  should be the second argument returned by `lmivar` when declaring  $X$ . All terms involving  $X$  are automatically removed from the list of LMI terms. The description of the resulting system of LMIs is returned in `newsys`.

**Example** Consider the LMI

$$0 < \begin{pmatrix} A^T Y + B^T Y A + Q & C X + D \\ X^T C^T + D^T & -(X + X^T) \end{pmatrix}$$

involving two variables  $X$  and  $Y$  with identifiers  $X$  and  $Y$ . To delete the variable  $X$ , type

```
lmisys = delmvar(lmisys,X)
```

Now `lmisys` describes the LMI

$$0 < \begin{pmatrix} A^T Y B + B^T Y A + Q & D \\ D^T & 0 \end{pmatrix}$$

with only one variable  $Y$ . Note that  $Y$  is still identified by the label  $Y$ .

**See Also**

|                      |                                                                                         |
|----------------------|-----------------------------------------------------------------------------------------|
| <code>lmivar</code>  | Specify the matrix variables in an LMI problem                                          |
| <code>setmvar</code> | Instantiate a matrix variable and evaluate all LMI terms involving this matrix variable |
| <code>lmiinfo</code> | Interactively retrieve information about the variables and term content of LMIs         |

---

|                    |                                                                                                                                                                                                                                                                                                                                                                                                                                                                                                                                                                                                                                  |
|--------------------|----------------------------------------------------------------------------------------------------------------------------------------------------------------------------------------------------------------------------------------------------------------------------------------------------------------------------------------------------------------------------------------------------------------------------------------------------------------------------------------------------------------------------------------------------------------------------------------------------------------------------------|
| <b>Purpose</b>     | Diagonalize and diagonals of uncertain matrices and systems                                                                                                                                                                                                                                                                                                                                                                                                                                                                                                                                                                      |
| <b>Syntax</b>      | <code>v = diag(x)</code>                                                                                                                                                                                                                                                                                                                                                                                                                                                                                                                                                                                                         |
| <b>Description</b> | If <code>x</code> is a vector of uncertain system models or matrices, <code>diag(x)</code> puts <code>x</code> on the main diagonal. If <code>x</code> is a matrix of uncertain system models or matrices, <code>diag(x)</code> is the main diagonal of <code>v</code> . <code>diag(diag(x))</code> is a diagonal matrix of uncertain system models or matrices.                                                                                                                                                                                                                                                                 |
| <b>Example</b>     | <p>The statement produces a diagonal system <code>mxg</code> of size 4-by-4. Given multivariable system <code>xx</code>, a vector of the diagonal elements of <code>xxg</code> are found using <code>diag</code>.</p> <pre>x = rss(3,4,1); xg = frd(x,logspace(-2,2,80)); size(xg)</pre> <p>FRD model with 4 output(s) and 1 input(s), at 80 frequency point(s).</p> <pre>mxg = diag(xg); size(mxg)</pre> <p>FRD model with 4 output(s) and 4 input(s), at 80 frequency point(s).</p> <pre>xxg = [xg(1:2,1) xg(3:4,1)]; m = diag(xxg); size(m)</pre> <p>FRD model with 2 output(s) and 1 input(s), at 80 frequency point(s).</p> |
| <b>See Also</b>    | <code>append</code> Group models by appending their inputs and outputs                                                                                                                                                                                                                                                                                                                                                                                                                                                                                                                                                           |

# dkitopt

---

**Purpose** Create an options object for use with dksyn

**Syntax**

```
dkitopt
options = dkitopt
options = dkitopt('name1',value1,'name2',value2,...)
```

**Description** dkitopt with no input or output arguments displays a complete list of option properties and their default values.

options = dkitopt creates an options object with all the properties set to their default values.

options = dkitopt('name1',value1,'name2',value2,...) creates a dkitopt object called options with specific values assigned to certain properties. Any unspecified property is set to its default value. When entering property names, it is sufficient to only type the leading characters that identify the name uniquely. Property names are not case-sensitive.

If the AutoIter property is set to 'off', the D-K iteration procedure is interactive. You are prompted to fit the D-Scale data and provide input on the control design process.

This table lists the dkitopt object properties.

| Object Property         | Description                                                                                                                                        |
|-------------------------|----------------------------------------------------------------------------------------------------------------------------------------------------|
| FrequencyVector         | Frequency vector used for analysis. Default is an empty matrix ([]) which results in the frequency range and number of points chosen automatically |
| InitialController       | Controller used to initiate first iteration. Default is an empty SS object.                                                                        |
| AutoIter                | Automated mu-synthesis mode. Default is 'on',                                                                                                      |
| DisplayWhileAutoIter    | Displays iteration progress in AutoIter mode. Default is 'off'.                                                                                    |
| StartingIterationNumber | Starting iteration number. Default is 1.                                                                                                           |

| <b>Object Property</b>    | <b>Description</b>                                                                                   |
|---------------------------|------------------------------------------------------------------------------------------------------|
| NumberOfAutoIterations    | Number of D-K iterations to perform. Default is 10.                                                  |
| AutoScalingOrder          | Maximum state order for fitting D-scaling data. Default is 5.                                        |
| AutoIterSmartTerminate    | Automatic termination of iteration procedure based on progress of design iteration. Default is 'on'. |
| AutoIterSmartTerminateTol | Tolerance used by AutoIterSmartTerminate. Default is 0.005.                                          |
| Default                   | A 1-by-1 structure of dkitopt property default values.                                               |
| Meaning                   | A 1-by-1 structure text description of each property.                                                |

**Example**

This statement creates a dkitopt options object called opt with all default values.

```

opt = dkitopt
Property Object Values:
    FrequencyVector: []
    InitialController: [0x0 ss]
    AutoIter: 'on'
    DisplayWhileAutoIter: 'off'
    StartingIterationNumber: 1
    NumberOfAutoIterations: 10
    AutoScalingOrder: 5
    AutoIterSmartTerminate: 'on'
    AutoIterSmartTerminateTol: 0.0050
    Default: [1x1 struct]
    Meaning: [1x1 struct]

```

The dksyn options object opt is updated with the following statements. The frequency vector is set to logspace (-2,3,80), the number of D-K iterations to 16, and the maximum state order of the fitted D-scale data to 9.

```
opt.FrequencyVector = logspace(-2,3,80);
opt.NumberOfAutoIterations = 16;
opt.AutoScalingOrder = 16;
opt
Property Object Values:
    FrequencyVector: [1x80 double]
    InitialController: [0x0 ss]
        AutoIter: 'on'
    DisplayWhileAutoIter: 'off'
    StartingIterationNumber: 1
    NumberOfAutoIterations: 16
    AutoScalingOrder: 16
    AutoIterSmartTerminate: 'on'
    AutoIterSmartTerminateTol: 0.0050
        Default: [1x1 struct]
        Meaning: [1x1 struct]
```

In this statement, the same properties are set with a single call to `robotopt`.

```
opt = dkitopt('FrequencyVector',logspace(-2,3,80),...
'NumberOfAutoIterations',16,'AutoScalingOrder',9)
Property Object Values:
    FrequencyVector: [1x80 double]
    InitialController: [0x0 ss]
        AutoIter: 'on'
    DisplayWhileAutoIter: 'off'
    StartingIterationNumber: 1
    NumberOfAutoIterations: 16
    AutoScalingOrder: 9
    AutoIterSmartTerminate: 'on'
    AutoIterSmartTerminateTol: 0.0050
        Default: [1x1 struct]
        Meaning: [1x1 struct]
```

## Algorithm

The `dksyn` command stops iterating before the total number of automated iterations ('NumberOfAutoIterations') if 'AutoIterSmartTerminate' is set to 'on' and a stopping criteria is satisfied. The stopping criteria involves the  $m(i)$  value of the current  $i$ th iteration,  $m(i-1)$  and  $m(i-2)$ , the previous two iterations and the options property 'AutoIterSmartTerminateTol'. The  $D-K$  iteration procedure automatically terminates if the difference between each of

the three  $\mu$  values is less than the relative tolerance of `AutoIterSmartTerminateTol`  $\times \mu(i)$  or the current  $\mu$  value,  $\mu(i)$ , has increased relative to the  $\mu$  value of the previous iteration  $\mu(i-1)$  by `20` $\times$ `AutoIterSmartTerminateTol`.

**See Also**

|                         |                                                             |
|-------------------------|-------------------------------------------------------------|
| <code>dksyn</code>      | Synthesize a robust controller via D-K iteration            |
| <code>h2syn</code>      | Synthesize a H2 optimal controller                          |
| <code>hinfsyn</code>    | Synthesize a $H_\infty$ optimal controller                  |
| <code>mussv</code>      | Calculate bounds on the Structured Singular Value ( $\mu$ ) |
| <code>robopt</code>     | Create a <code>robustperf/robuststab</code> option object   |
| <code>robuststab</code> | Calculate stability margins of uncertain systems            |
| <code>robustperf</code> | Calculate performance margins of uncertain systems          |
| <code>wcgopt</code>     | Create a <code>wcgain</code> option object                  |

**Purpose**                    Synthesis of a robust controller via  $\mu$ -synthesis D-K iteration

**Syntax**

```
k = dksyn(p,nmeas,ncont)
[k,clp,bnd] = dksyn(p,nmeas,ncont)
[k,clp,bnd] = dksyn(p,nmeas,ncont,opt)
[k,clp,bnd,dkinfo] = dksyn(p,nmeas,ncont,prevdkinfo,opt)
[k,clp,bnd,dkinfo] = dksyn(p)
```

**Description**

dksyn synthesizes a robust controller via D-K iteration. The D-K iteration procedure is an approximation to  $\mu$ -synthesis control design. The objective of  $\mu$ -synthesis is to minimize the structure singular value  $\mu$  of the corresponding robust performance problem associated with the uncertain system  $p$ . The uncertain system  $p$  is an open-loop interconnection containing known components including the nominal plant model, uncertain parameters (`ucomplex`) and unmodeled LTI dynamics (`ultidyn`) and performance and uncertainty weighting functions. You use weighting functions to include magnitude and frequency shaping information into the optimization. The control objective is to synthesize a stabilizing controller  $k$  that minimizes the robust performance  $\mu$  value, which corresponds to `bnd`.

The D-K iteration procedure involves a sequence of minimizations, first over the controller variable  $K$  (holding the  $D$  variable associated with the scaled  $\mu$  upper bound fixed), and then over the  $D$  variable (holding the controller  $K$  variable fixed). The D-K iteration procedure is not guaranteed to converge to the minimum  $\mu$  value, but often works well in practice. `dksyn` automates the D-K iteration procedure and the option object `dkitopt` allows you to customize its behavior.

`[k,clp,bnd] = dksyn(p,nmeas,ncont)` synthesizes a robust controller,  $k$ , for the uncertain open-loop plant model,  $p$ , via the D-K iteration.  $p$  is a `uss` and has `nmeas` measurement outputs and `ncont` control inputs. It is assumed that the measurement outputs and control inputs correspond to the last `nmeas` outputs and `ncont` inputs.  $k$  is the controller, `clp` is the closed-loop interconnection and `bnd` is the robust performance bound for the uncertain closed-loop system `clp`.  $p$ ,  $k$ , `clp`, and `bnd` are related as follows:

```
clp = lft(p,k);
bnd = robustperf(clp);
```



`[k,clp,bnd] = dksyn(p,nmeas,ncont,opt)` specifies options described in `dkitopt`. `opt` is created via the command `opt=dkitopt`. See `dkitopt` for more details.

`[k,clp,bnd,dkinfo] = dksyn(p,nmeas,ncont,prevdkinfo,opt)` uses information from a previous `dksyn` iteration. `prevdkinfo` is a structure from a previous attempt at designing a robust controller using `dksyn`. `prevdkinfo` is used when the `dksyn` starting iteration is not 1 (`opt.StartingIterationNumber = 1`) to determine the correct D-scalings to initiate the iteration procedure.

`dkinfo` is a N-by-1 cell array where N is the total number of iterations performed. The i'th cell contains a structure with the following fields:

| Field     | Description                                                   |
|-----------|---------------------------------------------------------------|
| K         | Controller at i'th iteration, a ss object.                    |
| Bnds      | Robust performance bound on the closed-loop system (double).  |
| DL        | Left D-scale, a ss object.                                    |
| DR        | Right D-scale, a ss object.                                   |
| MussvBnds | Upper and lower m bounds, a frd object.                       |
| MussvInfo | Structure returned from <code>mussv</code> at each iteration. |

`k = dksyn(p)` is a valid calling argument provided `p` is a `uss` object and has two-input-two-output partitioning as defined by `mktito`.

### Example

The following statements create a robust performance control design for an unstable, uncertain single-input/single-output plant model. The nominal plant

model,  $G$ , is an unstable first order system  $\frac{s}{s-1}$ .

```
G = tf(1,[1 -1]);
```

The model itself is uncertain. At low frequency, below 2 rad/s, it can vary up to 25% from its nominal value. Around 2 rad/s the percentage variation starts to

increase and reaches 400% at approximately 32 rad/s. The percentage model uncertainty is represented by the weight,  $W_u$ , which corresponds to the frequency variation of the model uncertainty and the uncertain LTI dynamic object InputUnc.

```
Wu = 0.25*tf([1/2 1],[1/32 1]);
InputUnc = ultidyn('InputUnc',[1 1]);T
```

The uncertain plant model,  $G_{pert}$ , represents the model of the physical system to be controlled.

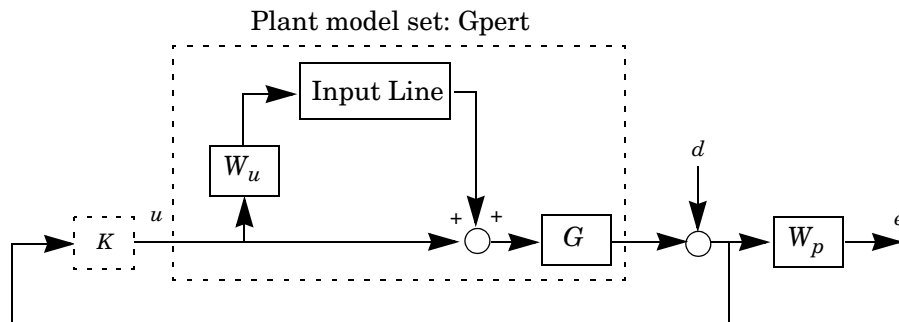

$$G_{pert} = G*(1+InputUnc*W_u);$$

The robust stability objective is to synthesize a stabilizing LTI controller for all the plant models parameterized by the uncertain plant model,  $G_{pert}$ . The control interconnection structure is shown in the following figure.

The goal is to synthesize a controller that stabilizes and achieves the closed-loop performance objectives for all possible plant models in the  $G_{pert}$ . The performance objective is defined as a weighted sensitivity minimization problem, see the above figure.

The sensitivity function,  $S$ , is defined as  $S = \frac{1}{1+PK}$  where  $P$  is the plant model and  $K$  is the controller. A weighted sensitivity minimization problem selects a weight  $W_p$  which corresponds to the *inverse* of the desired sensitivity function of the closed-loop system as a function of frequency. Hence the product of the sensitivity weight  $W_p$  and actual closed-loop sensitivity function is less

than 1 across all frequencies. The sensitivity weight  $W_p$  has a gain of 100 at low frequency begins to decrease at 0.006 rad/s and reaches a minimum magnitude of 0.25 after 2.4 rad/s.

```
Wp = tf([1/4 0.6],[1 0.006]);
```

The defined sensitivity weight  $W_p$  implies that the desired disturbance rejection should be at least 100:1 disturbance rejection at DC, rise slowly between 0.006 and 2.4 rad/s, and allow the disturbance rejection to increase above the open-loop level, 0.25, at high frequency.

For the case when the plant model is uncertain, the closed-loop performance objective is to achieve the desired sensitivity function for all plant models defined by the uncertain plant model,  $G_{pert}$ . The performance objective for an uncertain system is a robust performance objective. A block diagram of this uncertain closed-loop system illustrating the performance objective (closed-loop transfer function from  $d \rightarrow e$ ) is shown in the following figure.

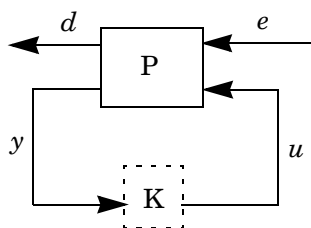

From the definition of the robust performance control objective, the weighted, uncertain control design interconnection model, which includes the robustness and performance objectives, can be constructed and is denoted by  $P$ . The robustness and performance weights are selected such that if the robust performance structure singular value,  $bnd$ , of the closed-loop uncertain system,  $c1p$ , is less than 1 then the performance objectives have been achieved for all the plant models in the model set.

You can form the uncertain transfer matrix,  $P$ , from  $[d; u]$  to  $[e; y]$  using the following commands.

```
P = [Wp; 1 ]*[1 Gpert];
[K,c1p,bnd] = dksyn(P,1,1);
bnd
bnd =
```

```
0.6860
P = [Wp; 1 ]*[1 Gpert];
[K,clp,bnd] = dksyn(P,1,1);
bnd
bnd =
0.6860
```

The controller  $K$  achieves a robust performance  $\mu$  value, `bnd`, of 0.685. Therefore you have achieved the robust performance objectives for the given problem.

You can use the `robustperf` command to analyze the closed-loop robust performance of `clp`.

```
[rpnorm,wcf,wcu,report] = robustperf(clp);
disp(report{1})
```

Uncertain system, `clp`, achieves robust performance. The our analysis showed `clp` can tolerate 146% of the model uncertainty and achieve the performance and stability objectives. A model uncertainty exists of size 146% that results in a peak gain performance of 0.686 at 0.569 rad/s.

## Algorithm

The  $D$ - $K$  iteration procedure is an approximation to  $\mu$  synthesis control design. It involves a sequence of minimizations, first over the controller variable  $K$  (holding the  $D$  variable associated with the scaled  $\mu$  upper bound fixed), and then over the  $D$  variable (holding the controller  $K$  variable fixed). The  $D$ - $K$  iteration procedure is not guaranteed to converge to the minimum  $\mu$  value, but often works well in practice.

`dksyn` automates the  $D$ - $K$  iteration procedure. Internally, the algorithm works with the generalized, scaled plant model  $P$  which is extracted from a `uss` object using the command `lftdata`.

The following is a list of what occurs during a single, complete step of the  $D$ - $K$  iteration.

- 7 (In the 1st iteration, this step is skipped.) The  $\mu$  calculation (from the previous step) provides a frequency-dependent scaling matrices,  $D_f$ . The

fitting procedure fits these scalings with rational, stable transfer function matrices. After fitting, plots of

$$\bar{\sigma}(D_f(j\omega)F_L(P, K)(j\omega)D_f^{-1}(j\omega))$$

and

$$\bar{\sigma}(\hat{D}_f(j\omega)F_L(P, K)(j\omega)\hat{D}_f^{-1}(j\omega))$$

are shown for comparison.

(In the 1st iteration, this step is skipped.) The rational  $\hat{D}$  is absorbed into the open-loop interconnection for the next controller synthesis. Using either the previous frequency-dependent  $D$ 's or the just-fit rational  $\hat{D}$ , an estimate of an appropriate value for the  $H_\infty$  norm is made. This is simply a conservative value of the scaled closed-loop  $H_\infty$  norm, using the most recent controller and either a frequency sweep (using the frequency-dependent  $D$ s) or a state-space calculation (with the rational  $D$ 's).

- 8** (The 1st iteration begins at this point.) A controller is designed using  $H_\infty$  synthesis on the scaled open-loop interconnection. If you set the `DisplayWhileAutoIter` field in `dkitopt` to 'on', the following information is displayed:
- a** The progress of the  $\gamma$ -iteration is displayed.
  - b** The singular values of the closed-loop frequency response are plotted.
  - c** You are given the option to change the frequency range. If you change it, all relevant frequency responses are automatically recomputed.
  - d** You are given the option to rerun the  $H_\infty$  synthesis with a set of modified parameters if you set the `AutoIter` field in `dkitopt` to 'off'. This is convenient if, for instance, the bisection tolerance was too large, or if maximum gamma value was too small.
- 9** The structured singular value of the closed-loop system are calculated and plotted.
- 10** An iteration summary is displayed, showing all of the controller order, as well as the peak value of  $\mu$  of the closed-loop frequency responses.
- 11** The choice of stopping, or performing another iteration is given.

Subsequent iterations proceed along the same lines without the need to re-enter the iteration number. A summary at the end of each iteration is updated to reflect data from all previous iterations. This often provides valuable information about the progress of the robust controller synthesis procedure.

### Interactive fitting of *D*-Scalings

Setting the `AutoIter` field in `dkitopt` to 'off' requires you interactively fit the *D*-scales each iteration. During step 2 of the *D*-*K* iteration procedure, you are prompted to enter your choice of options for fitting the *D*-scaling data. After pressing return, the following is a list of your options.

```
Enter Choice (return for list):
Choices:
nd          Move to Next D-Scaling
nb          Move to Next D-Block

i           Increment Fit Order
d           Decrement Fit Order
apf        Auto-PreFit
mx 3       Change Max-Order to 3
at 1.01    Change Auto-PreFit tol to 1.01
0          Fit with zeroth order
2          Fit with second order
n          Fit with n'th order
e          Exit with Current Fittings
s          See Status
```

- `nd` and `nb` allow you to move from one *D*-scale data to another. `nd` moves to the next scaling, whereas `nb` moves to the next scaling block. For scalar *D*-scalings, these are identical operations, but for problems with full *D*-scalings, (perturbations of the form  $\delta I$ ) they are different. In the (1,2) subplot window, the title displays the *D*-scaling Block number, the row/column of the scaling that is currently being fit, and the order of the current fit (with `d` for data, when no fit exists).
- The order of the current fit can be incremented or decremented (by 1) using `i` and `d`.

- apf automatically fits each  $D$ -scaling data. The default maximum state order of individual  $D$ -scaling is 5. The  $mx$  variable allows you to change the maximum  $D$ -scaling state order used in the automatic prefitting routine.  $mx$  must be a positive, nonzero integer.  $at$  allows you to define how close the rational, scaled  $\mu$  upper bound is to approximate the actual  $\mu$  upper bound in a norm sense. Setting  $at = 1$  would require an exact fit of the  $D$ -scale data, and is not allowed. Allowable values for  $at$  are greater than 1. This setting plays a role (mildly unpredictable, unfortunately) in determining where in the  $(D,K)$  space the  $D$ - $K$  iteration converges.
- Entering a positive integer at the prompt will fit the current  $D$ -scale data with that state order rational transfer function.
- $e$  exits the  $D$ -scale fitting to continue the  $D$ - $K$  iteration.
- The variable  $s$  will display a status of the current and fits.

## Limitations

There are two shortcomings of the  $D - K$  iteration control design procedure:

- Calculation of the structured singular value,  $\mu_{\Delta}(\cdot)$ , has been approximated by its upper bound. This is not a serious problem since the value of  $\mu$  and its upper bound are often close.
- The  $D - K$  iteration is not guaranteed to converge to a global, or even local minimum [SteD]. This is a serious problem, and represents the biggest limitation of the design procedure.

In spite of these drawbacks, the  $D - K$  iteration control design technique appears to work well on many engineering problems. It has been applied to a number of real world applications with success. These applications include: vibration suppression for flexible structures, flight control, chemical process control problems, and acoustic reverberation suppression in enclosures.

## Reference

- Balas, G.J. and J.C. Doyle, "Robust control of flexible modes in the controller crossover region," *AIAA Journal of Guidance, Dynamics and Control*, Vol. 17, no. 2, pp. 370–377, March-April, 1994.
- Balas, G.J., A.K. Packard and J.T. Harduvel, "Application of  $\mu$ -synthesis techniques to momentum management and attitude control of the space station," *AIAA Guidance, Navigation and Control Conference*, New Orleans, August 1991.
- Doyle, J.C., Doyle, K. Lenz, and A. Packard, "Design examples using  $\mu$ -synthesis: Space shuttle lateral axis FCS during reentry," *NATO ASI*

*Series, Modelling, Robustness, and Sensitivity Reduction in Control Systems*, vol. 34, Springer-Verlag, 1987.

- Packard, A., J. Doyle, and G. Balas, “Linear, multivariable robust control with a  $\mu$  perspective,” *ASME Journal of Dynamic Systems, Measurement and Control*, 50th Anniversary Issue, vol. 115, no. 2b, pp. 310–319, June 1993.
- [SteD:] Stein, G., and J. Doyle, “Beyond singular values and loopshapes,” *AIAA Journal of Guidance and Control*, vol. 14, num. 1, pp. 5-16, January, 1991.

## See Also

|            |                                                             |
|------------|-------------------------------------------------------------|
| dkitopt    | Create a dksyn options object                               |
| h2syn      | Synthesize a $H_2$ optimal controller                       |
| hinfsyn    | Synthesize a $H_\infty$ optimal controller                  |
| loopmargin | Comprehensive analysis of feedback loop                     |
| mktito     | Create a two-input/two-output LTI partition                 |
| mussv      | Calculate bounds on the Structured Singular Value ( $\mu$ ) |
| robuststab | Calculate stability margins of uncertain systems            |
| robustperf | Calculate performance margins of uncertain systems          |
| wcgain     | Calculate worst-case gain of a system                       |
| wcsens     | Calculate worst-case sensitivities for feedback loop        |
| wcmargin   | Calculate worst-case margins for feedback loop              |



**Purpose** Interpret disk gain and phase margins

**Syntax**

```
dmplot
dmplot(diskgm)
[dgm,dpm] = dmplot
```

**Description** dmplot plots disk gain margin (dgm) and disk phase margin (dpm). Both margins are derived from the largest disk that

- contains the critical point (-1,0)
- does not intersect the Nyquist plot of the open-loop response L

diskgm is the radius of this disk and a lower bound on the classical gain margin.

dmplot(diskgm) plots the maximum allowable phase variation as a function of the actual gain variation for a given disk gain margin diskgm (the maximum gain variation being diskgm). The closed-loop system is guaranteed to remain stable for all combined gain/phase variations inside the plotted ellipse.

[dgm,dpm] = dmplot returns the data used to plot the gain/phase variation ellipse.

**Example** When you call dmplot (without an argument), the resulting plot shows a comparison of a disk margin analysis with the classical notations of gain and phase margins. The Nyquist plot is of the loop transfer function L(s)

$$L(s) = \frac{\frac{s}{30} + 1}{(s + 1)(s^2 + 1.6s + 16)}$$

- The Nyquist plot of L corresponds to the blue line.
- The unit disk corresponds to the dotted red line.
- GM and PM indicate the location of the classical gain and phase margins for the system L.
- DGM and DPM correspond to the disk gain and phase margins, respectively. The disk margins provide a lower bound on classical gain and phase margins.

- The disk margin circle, represented by the dashed black line, corresponds to the largest disk centered at  $(\text{GMD} + 1/\text{GMD})/2$  that just touches the loop transfer function  $L$ . This location is indicated by the red dot.

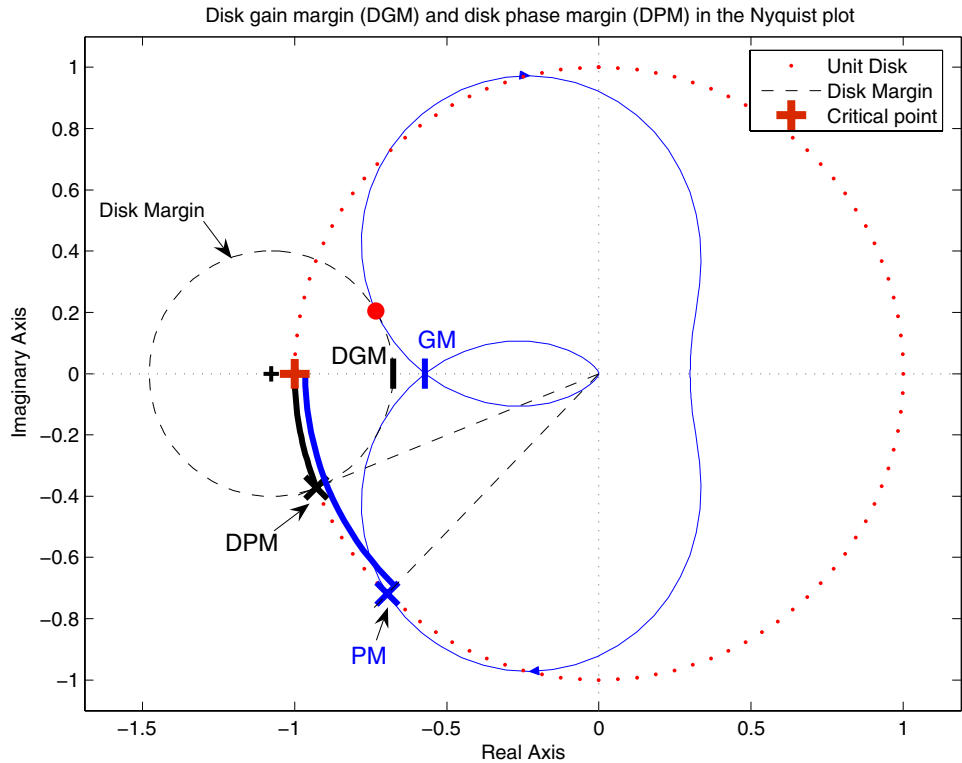

The x-axis corresponds to the gain variation, in dB, and the y-axis corresponds to the phase variation allowable, in degrees. For a disk gain margin corresponding to 3 dB (1.414), the closed-loop system is stable for all phase and gain variations inside the blue ellipse. For example, the closed-loop system can simultaneously tolerate  $\pm 2$  dB gain variation and  $\pm 14$  deg phase variations.

```
dmp1ot(1.414)
```

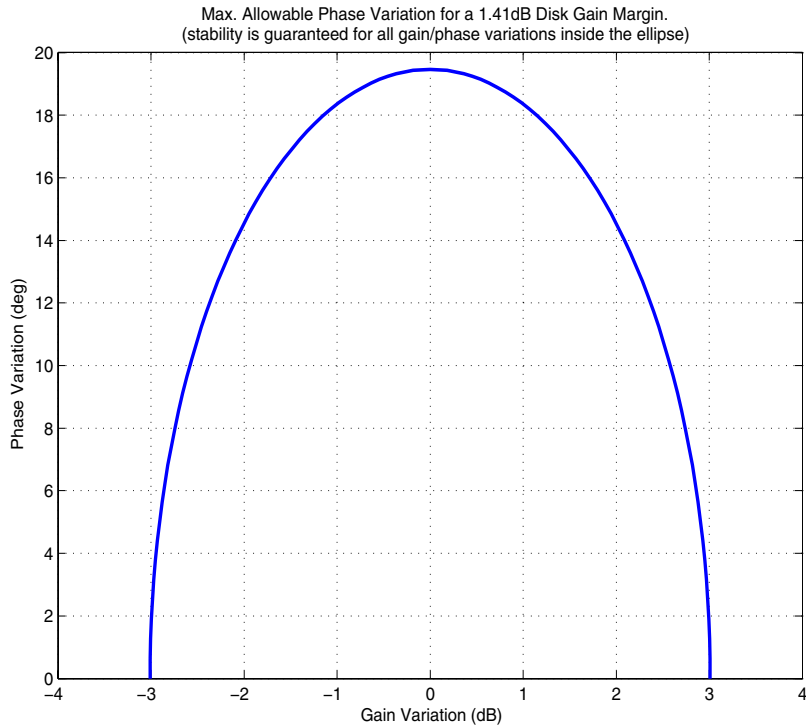

## Reference

Barrett, M.F. (1980), Conservatism with robustness tests for linear feedback control systems, *Ph.D. Thesis*, Control Science and Dynamical Systems, University of Minnesota.

Blight, J.D., Dailey, R.L. and Gangsass, D. (1994), "Practical control law design for aircraft using multivariable techniques," *International Journal of Control*, Vol. 59, No. 1, 93-137.

Bates, D. and I. Postlethwaite (2002), Robust Multivariable Control of Aerospace Systems, *Delft University Press*, Delft, The Netherlands, ISBN: 90-407-2317-6.

## See Also

loopmargin

Comprehensive stability analysis of feedback loops

# dmplot

---

wmargin

Calculate worst-case margins for feedback loop

**Purpose** A mouse-based tool for sketching and fitting

**Syntax**  
`[sysout,pts] = drawmag(data)`  
`[sysout,pts] = drawmag(data,init_pts)`

**Description** drawmag interactively uses the mouse in the plot window to create pts (the frd object) and sysout (a stable minimum-phase ss object), which approximately fits the frequency response (magnitude) in pts.

Input arguments:

data either a frequency response object that is plotted as a reference, or a constant matrix of the form  $[x_{min} \ x_{max} \ y_{min} \ y_{max}]$  specifying the plot window on the data.

init\_pts optional frd objects of initial set of points

Output arguments:

sysout Stable, minimum phase ss object which approximately fits, in magnitude, the pts data.

pts Frequency response of points.

While drawmag is running, all interaction with the program is through the mouse and/or the keyboard. The mouse, if there is one, must be in the plot window. The program recognizes several commands:

- Clicking the mouse button adds a point at the crosshairs. If the crosshairs are outside the plotting window, the points will be plotted when the fitting, windowing, or replotting modes are invoked. Typing a is the same as clicking the mouse button.
- Typing r removes the point with frequency nearest that of the crosshairs.
- Typing any integer between 0-9 fits the existing points with a transfer function of that order. The fitting routine approximately minimizes the maximum error in a log sense. The new fit is displayed along with the points, and the most recent previous fit, if it exists.
- Typing w uses the crosshair location as the initial point in creating a window. Moving the crosshairs and clicking the mouse or pressing any key then gives

# drawmag

---

a second point at the new crosshair location. These two points define a new window on the data, which is immediately replotted. This is useful in fine tuning parts of the data. Windowing may be called repeatedly.

- Typing `p` simply replots the data using a window that covers all the current data points as well as whatever was specified in `in`. Typically used after windowing to view all the data.
- Typing `k` invokes the keyboard using the keyboard command. Caution should be exercised when using this option, as it can wreak havoc on the program if variables are changed.

## See Also

`ginput`  
`loglog`

Graphically input information from mouse  
Plotting frequency responses on log-log scale

**Purpose** Given a particular instance of the decision variables, evaluate all variable terms in the system of LMIs

**Syntax** `evalsys = evallmi(lmisys,decvars)`

**Description** `evallmi` evaluates all LMI constraints for a particular instance `decvars` of the vector of decision variables. Recall that `decvars` fully determines the values of the matrix variables  $X_1, \dots, X_K$ . The “evaluation” consists of replacing all terms involving  $X_1, \dots, X_K$  by their matrix value. The output `evalsys` is an LMI system containing only constant terms.

The function `evallmi` is useful for validation of the LMI solvers’ output. The vector returned by these solvers can be fed directly to `evallmi` to evaluate all variable terms. The matrix values of the left- and right-hand sides of each LMI are then returned by `showlmi`.

**Observation** `evallmi` is meant to operate on the output of the LMI solvers. To evaluate all LMIs for particular instances of the matrix variables  $X_1, \dots, X_K$ , first form the corresponding decision vector  $x$  with `mat2dec` and then call `evallmi` with  $x$  as input.

**Example** Consider the feasibility problem of finding  $X > 0$  such that

$$A^T X A - X + I < 0$$

where  $A = \begin{pmatrix} 0.5 & -0.2 \\ 0.1 & -0.7 \end{pmatrix}$ . This LMI system is defined by:

```
setlmis([])
X = lmivar(1,[2 1]) % full symmetric X

lmiterm([1 1 1 X],A',A) % LMI #1: A'*X*A
lmiterm([1 1 1 X],[-1,1]) % LMI #1: -X
lmiterm([1 1 1 0],1) % LMI #1: I
lmiterm([-2 1 1 X],1,1) % LMI #2: X
lmis = getlmis
```

To compute a solution `xfeas`, call `feasp` by

```
[tmin,xfeas] = feasp(lmis)
```

The result is

```
tmin =  
    -4.7117e+00
```

```
xfeas' =  
    1.1029e+02  -1.1519e+01  1.1942e+02
```

The LMI constraints are therefore feasible since  $tmin < 0$ . The solution  $X$  corresponding to the feasible decision vector  $xfeas$  would be given by  $X = dec2mat(lmis, xfeas, X)$ .

To check that  $xfeas$  is indeed feasible, evaluate all LMI constraints by typing

```
evals = evallmi(lmis, xfeas)
```

The left- and right-hand sides of the first and second LMIs are then given by

```
[lhs1, rhs1] = showlmi(evals, 1)  
[lhs2, rhs2] = showlmi(evals, 2)
```

and the test

```
eig(lhs1 - rhs1)  
ans =  
    -8.2229e+01  
    -5.8163e+01
```

confirms that the first LMI constraint is satisfied by  $xfeas$ .

## See Also

|         |                                                                                                    |
|---------|----------------------------------------------------------------------------------------------------|
| showlmi | Return the left- and right-hand sides of an LMI after evaluation of all variable terms             |
| setmvar | Instantiate a matrix variable and evaluate all LMI terms involving this matrix variable            |
| dec2mat | Given values of the decision variables, derive the corresponding values of the matrix variables    |
| mat2dec | Return the vector of decision variables corresponding to particular values of the matrix variables |



**Purpose** Find a solution to a given system of LMIs

**Syntax** `[tmin,xfeas] = feasp(lmisys,options,target)`

**Description** The function `feasp` computes a solution `xfeas` (if any) of the system of LMIs described by `lmisys`. The vector `xfeas` is a particular value of the decision variables for which all LMIs are satisfied.

Given the LMI system

$$N^T L x N \leq M^T R(x) M, \quad (10-5)$$

`xfeas` is computed by solving the auxiliary convex program:

Minimize  $t$  subject to  $\mathcal{N}^T \mathcal{L}(x) \mathcal{N} \preceq \mathcal{M}^T \mathcal{R}(x) \mathcal{M} \leq t I$ .

The global minimum of this program is the scalar value `tmin` returned as first output argument by `feasp`. The LMI constraints are feasible if `tmin`  $\geq 0$  and strictly feasible if `tmin`  $< 0$ . If the problem is feasible but not strictly feasible, `tmin` is positive and very small. Some post-analysis may then be required to decide whether `xfeas` is close enough to feasible.

The optional argument `target` sets a target value for `tmin`. The optimization code terminates as soon as a value of  $t$  below this target is reached. The default value is `target = 0`.

Note that `xfeas` is a solution in terms of the decision variables and not in terms of the matrix variables of the problem. Use `dec2mat` to derive feasible values of the matrix variables from `xfeas`.

### Control Parameters

The optional argument `options` gives access to certain control parameters for the optimization algorithm. This five-entry vector is organized as follows:

- `options(1)` is not used
- `options(2)` sets the maximum number of iterations allowed to be performed by the optimization procedure (100 by default)
- `options(3)` resets the *feasibility radius*. Setting `options(3)` to a value  $R > 0$  further constrains the decision vector  $x = (x_1, \dots, x_N)$  to lie within the ball

$$\sum_{i=1}^N x_i^2 < R^2$$

In other words, the Euclidean norm of `xfeas` should not exceed  $R$ . The feasibility radius is a simple means of controlling the magnitude of solutions. Upon termination, `feasp` displays the *f-radius saturation*, that is, the norm of the solution as a percentage of the feasibility radius  $R$ .

The default value is  $R = 10^9$ . Setting `options(3)` to a negative value activates the “flexible bound” mode. In this mode, the feasibility radius is initially set to  $10^8$ , and increased if necessary during the course of optimization

- `options(4)` helps speed up termination. When set to an integer value  $J > 0$ , the code terminates if  $t$  did not decrease by more than one percent in relative terms during the last  $J$  iterations. The default value is 10. This parameter trades off speed vs. accuracy. If set to a small value ( $< 10$ ), the code terminates quickly but without guarantee of accuracy. On the contrary, a large value results in natural convergence at the expense of a possibly large number of iterations.
- `options(5) = 1` turns off the trace of execution of the optimization procedure. Resetting `options(5)` to zero (default value) turns it back on.

Setting `option(i)` to zero is equivalent to setting the corresponding control parameter to its default value. Consequently, there is no need to redefine the entire vector when changing just one control parameter. To set the maximum number of iterations to 10, for instance, it suffices to type

```
options=zeros(1,5)    % default value for all parameters
options(2)=10
```

## Memory Problems

When the least-squares problem solved at each iteration becomes ill conditioned, the `feasp` solver switches from Cholesky-based to QR-based linear algebra (see “Memory Problems” on page 10-191 for details). Since the QR mode typically requires much more memory, MATLAB may run out of memory and display the message

```
??? Error using ==> feaslsv
Out of memory. Type HELP MEMORY for your options.
```

You should then ask your system manager to increase your swap space or, if no additional swap space is available, set options(4) = 1. This will prevent switching to QR and feasp will terminate when Cholesky fails due to numerical instabilities.

### Example

Consider the problem of finding  $P > I$  such that

$$A_1^T P + P A_1 < 0 \quad (10-6)$$

$$A_2^T P + P A_2 < 0 \quad (10-7)$$

$$A_3^T P + P A_3 < 0 \quad (10-8)$$

with data

$$A_1 = \begin{pmatrix} -1 & 2 \\ 1 & -3 \end{pmatrix}, \quad A_2 = \begin{pmatrix} -0.8 & 1.5 \\ 1.3 & -2.7 \end{pmatrix}, \quad A_3 = \begin{pmatrix} -1.4 & 0.9 \\ 0.7 & -2.0 \end{pmatrix}$$

This problem arises when studying the quadratic stability of the polytope of matrices  $\text{Co}\{A_1, A_2, A_3\}$ .

To assess feasibility with feasp, first enter the LMIs (9-8)–(9-10) by:

```
setlmis([])
p = lmivar(1,[2 1])

lmiterm([1 1 1 p],1,a1,'s') % LMI #1
lmiterm([2 1 1 p],1,a2,'s') % LMI #2
lmiterm([3 1 1 p],1,a3,'s') % LMI #3
lmiterm([-4 1 1 p],1,1) % LMI #4: P
lmiterm([4 1 1 0],1) % LMI #4: I
lmis = getlmis
```

Then call feasp to find a feasible decision vector:

```
[tmin,xfas] = feasp(lmis)
```

This returns  $t_{\min} = -3.1363$ . Hence (9-8)–(9-10) is feasible and the dynamical system  $\dot{x} = A(t)x$  is quadratically stable for  $A(t) \in \text{Co}\{A_1, A_2, A_3\}$ .

To obtain a Lyapunov matrix  $P$  proving the quadratic stability, type

```
P = dec2mat(lmis, xfeas, p)
```

This returns

$$P = \begin{pmatrix} 270.8 & 126.4 \\ 126.4 & 155.1 \end{pmatrix}$$

It is possible to add further constraints on this feasibility problem. For instance, you can bound the Frobenius norm of  $P$  by 10 while asking  $t_{\min}$  to be less than or equal to  $-1$ . This is done by

```
[tmin, xfeas] = feasp(lmis, [0, 0, 10, 0, 0], -1)
```

The third entry 10 of options sets the feasibility radius to 10 while the third argument  $-1$  sets the target value for  $t_{\min}$ . This yields  $t_{\min} = -1.1745$  and a matrix  $P$  with largest eigenvalue  $\lambda_{\max}(P) = 9.6912$ .

## Reference

The feasibility solver `feasp` is based on Nesterov and Nemirovski's Projective Method described in

Nesterov, Y., and A. Nemirovski, *Interior Point Polynomial Methods in Convex Programming: Theory and Applications*, SIAM, Philadelphia, 1994.

Nemirovski, A., and P. Gahinet, "The Projective Method for Solving Linear Matrix Inequalities," *Proc. Amer. Contr. Conf.*, 1994, Baltimore, Maryland, pp. 840–844.

The optimization is performed by the C-MEX file `feaslv.mex`.

## See Also

|                      |                                                                                                 |
|----------------------|-------------------------------------------------------------------------------------------------|
| <code>mincx</code>   | Minimize a linear objective under LMI constraints                                               |
| <code>gevp</code>    | Generalized eigenvalue minimization under LMI constraints                                       |
| <code>dec2mat</code> | Given values of the decision variables, derive the corresponding values of the matrix variables |

**Purpose**

Fit D-scaling frequency response data with state-space model

**Syntax**

```
B = fitfrd(A,N)
B = fitfrd(A,N,RD)
B = fitfrd(A,N,RD,WT)
```

**Description**

`B = fitfrd(A,N)` is a state-space object with state-dimension `N`, where `A` is a `frd` object and `N` is a nonnegative integer. The frequency response of `B` closely matches the D-scale frequency response data in `A`.

`A` must have either 1 row or 1 column, though it need not be 1-by-1. `B` will be the same size as `A`. In all cases, `N` should be a nonnegative scalar.

`B = fitfrd(A,N,RD)` forces the relative degree of `B` to be `RD`. `RD` must be a nonnegative integer. The default value for `RD` is 0. If `A` is a row (or column) then `RD` can be a vector of the same size as well, specifying the relative degree of each entry of `B`. If `RD` is a scalar, then it specifies the relative degree for all entries of `B`. The default for `RD` can also be specified by setting `RD` to an empty matrix.

`B = fitfrd(A,N,RD,WT)` uses the magnitude of `WT` to weight the optimization fit criteria. `WT` may be a `double`, `ss` or `frd`. If `WT` is a scalar, then it is used to weight all entries of the error criteria (`A-B`). If `WT` is a vector, it must be the same size as `A`, and each individual entry of `WT` acts as a weighting function on the corresponding entry of (`A-B`).

**Example**

You can use the `fitfrd` command to fit D-scale data. For example, create D-scale frequency response data from a fifth order system.

```
sys = tf([1 2 2],[1 2.5 1.5])*tf(1,[1 0.1]);
sys = sys*tf([1 3.75 3.5],[1 2.5 13]);
omeg = logspace(-1,1);
sysg = frd(sys,omeg);
```

```
bode(sysg, 'r-');
```

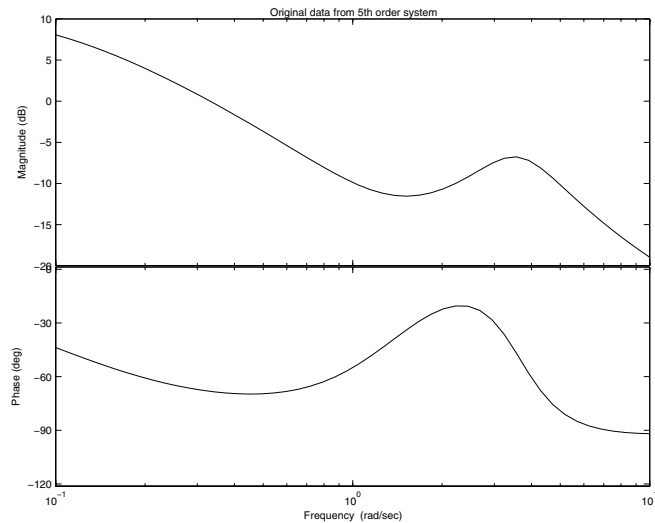

You can try to fit the frequency response D-scale data, `sysg`, with a first order system, `b1`. Similarly, you can fit the D-scale data with a third order system, `b3`.

```
b1 = fitfrd(sysg,1);  
b3 = fitfrd(sysg,3);
```

Compare the original D-scale data, `sysg`, with the frequency responses of the first and third order models calculated by `fitfrd`.

```
b1g = frd(b1,omeg);  
b3g = frd(b3,omeg);
```

```
bode(sysg, 'r-', b1g, 'k:', b3g, 'b-.')
```

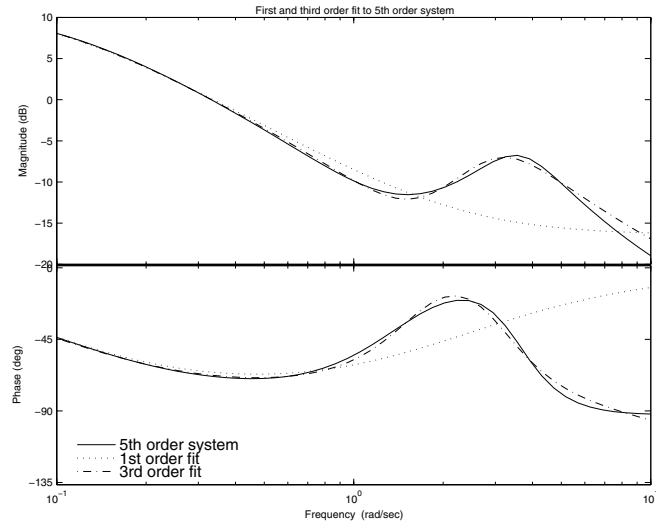

## Limitations

Numerical conditioning problems arise if the state order of the fit,  $N$ , is selected to be higher than required by the dynamics of  $A$ .

## See Also

fitmagfrd

Fit magnitude data with stable LTI model

# fitmagfrd

---

**Purpose** Fit frequency response magnitude data with a stable, minimum-phase state-space model

**Syntax**

```
B = fitmagfrd(A,N)
B = fitmagfrd(A,N,RD)
B = fitmagfrd(A,N,RD,WT)
B = fitmagfrd(A,N,RD,WT,C)
```

**Description** `B = fitmagfrd(A,N)` is a stable, minimum-phase `ss` object, with state-dimension `N`, whose frequency response magnitude closely matches the magnitude data in `A`. `A` is a 1-by-1 `frd` object, and `N` is a nonnegative integer.

`B = fitmagfrd(A,N,RD)` forces the relative degree of `B` to be `RD`. `RD` must be a nonnegative integer whose default value is 0. The default for `RD` can also be specified by setting `RD` to an empty matrix.

`B = fitmagfrd(A,N,RD,WT)` uses the magnitude of `WT` to weight the optimization fit criteria. `WT` may be a `double`, `ss` or `frd`. If `WT` is a scalar, then it is used to weight all entries of the error criteria  $(A-B)$ . If `WT` is a vector, it must be the same size as `A`, and each individual entry of `WT` acts as a weighting function on the corresponding entry of  $(A-B)$ . The default value for `WT` is 1, and can also be specified by setting `WT` to an empty matrix.

`B = fitmagfrd(A,N,RD,WT,C)` enforces additional magnitude constraints on `B`, relative to `A` as:

- if  $C(w) == -1$ , then enforce  $\text{abs}(B(w)) \leq \text{abs}(A(w))$
- if  $C(w) == 1$ , then enforce  $\text{abs}(B(w)) \geq \text{abs}(A(w))$
- if  $C(w) == 0$ , then no additional constraint

where `w` denotes the frequency. `C` should be a scalar, `double`, or `frd`, with `C.Frequency` equal to `A.Frequency`.

**Example** You can use the `fitmagfrd` command to fit frequency response magnitude data. Create frequency response data from a fifth order system.

```
sys = tf([1 2 2],[1 2.5 1.5])*tf(1,[1 0.1]);
sys = sys*tf([1 3.75 3.5],[1 2.5 13]);
omeg = logspace(-1,1);
sysg = abs(frd(sys,omeg));
```



```
bodemag(sysg, 'r');
```

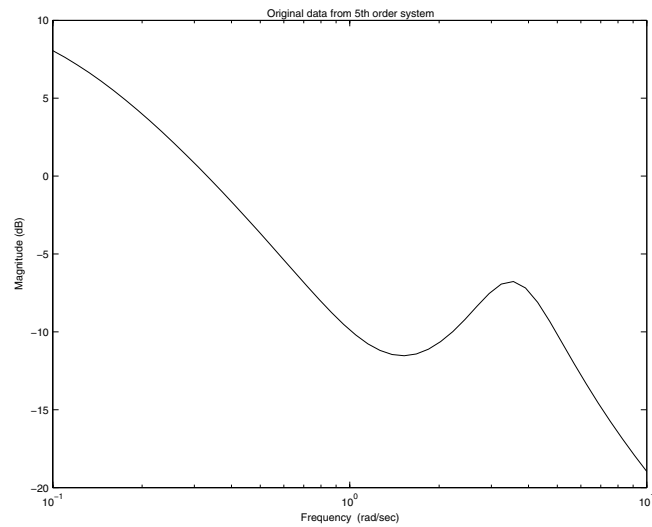

Fit the magnitude data with a minimum phase, stable third order system

```
ord = 3;  
b1 = fitmagfrd(sysg,ord);  
b1g = frd(b1,omeg);
```

# fitmagfrd

```
bodemag(sysg, 'r', b1g, 'k:');
```

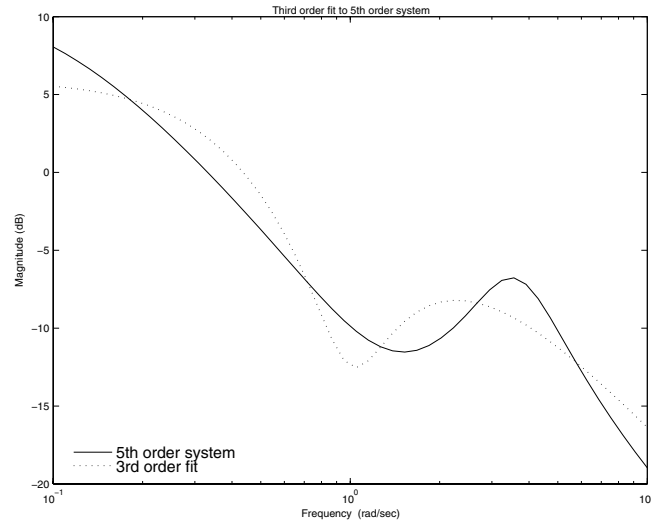

Fit the magnitude data with a third order system constrained to lie below and above the given data.

```
b2 = fitmagfrd(sysg,ord,[],[],-1);  
b2g = frd(b2,omeg);  
b3 = fitmagfrd(sysg,ord,[],[],1);  
b3g = frd(b3,omeg);
```

```
bodemag(sysg, 'r', b1g, 'k:', b2g, 'b-.', b3g, 'm--')
```

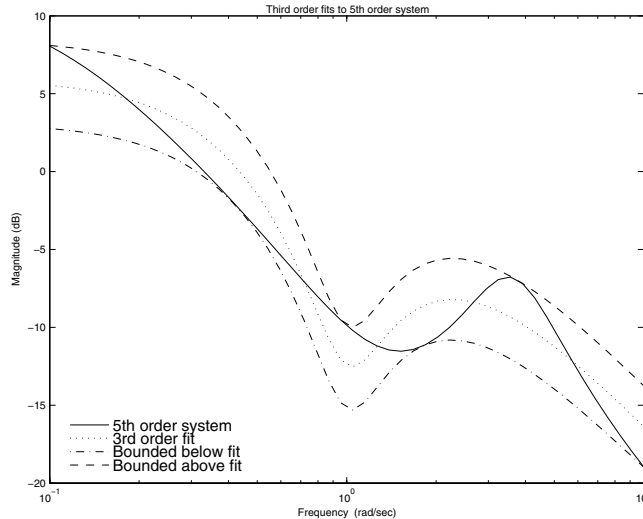

**Algorithm**

fitmagfrd uses a version of log-Chebyshev magnitude design, solving

$$\min f \quad \text{subject to (at every frequency point in A):}$$

$$|d|^2 / (1 + f/WT) < |n|^2 / A^2 < |d|^2 * (1 + f/WT)$$

plus additional constraints imposed with C. n, d denote the numerator and denominator respectively and B = n/d. n and d have orders (N-RD) and N, respectively. The problem is solved using bisection on f and linear programming for fixed f. An alternate approximate method, which cannot enforce the constraints defined by C, is B = fitfrd(genphase(A), N, RD, WT).

**Limitations**

This input FRD object must be either a scalar 1-by-1 object, a row or column vector.

**Reference**

Oppenheim, A.V., and R.W. Schaffer, *Digital Signal Processing*, Prentice Hall, New Jersey, 1975, pp. 513.

# fitmagfrd

---

## See Also

`fitfrd`

Fits frequency response data with state-space model

**Purpose** Computes upper bounds on the gap and nugap distances (metric) between two systems

**Syntax** `[gap,nugap] = gapmetric(p0,p1)`  
`[gap,nugap] = gapmetric(p0,p1,tol)`

**Description** `[gap,nugap] = gapmetric(p0,p1)` calculates upper bounds on the gap and nugap metric between systems `p0` and `p1`. The gap and nugap values lie between 0 and 1. A small value (relative to 1) implies that any controller which stabilizes `p0` will likely stabilize `p1`, and moreover, that the closed-loop gains of the two closed-loop systems will be similar. A gap or nugap of 0 implies that `p0` equals `p1` and a value of 1 implies that the plants are far apart. The input and output dimensions of `p0` and `p1` must be the same.

`[gap,nugap] = gapmetric(p0,p1,tol)` specifies a relative accuracy for calculating the gap metric and nugap metric. The default value for `tol` is 0.001. The computed answers are guaranteed to satisfy

$$\text{gap} - \text{tol} < \text{gapexact}(p0,p1) \leq \text{gap}$$

**Example** Consider two plant models. One plant is a unstable, first order, with transfer function  $1/(s-0.001)$  and the other plant is stable first order with transfer function  $1/(s+0.001)$ .

```
p1 = tf(1,[1 -0.001]);
p2 = tf(1,[1 0.001]);
```

Despite the fact that one plant is unstable and the other is stable, these plants are *close* in the gap and nugap metrics. Intuitively, this is obvious, since, for instance, the feedback controller  $K=1$  will stabilize both plants, and render the closed-loop systems nearly identical.

```
[g,ng] = gapmetric(p1,p2)
g =
    0.0029
ng =
    0.0020
K = 1;
H1 = loopsens(p1,K);
H2 = loopsens(p2,K);
subplot(2,2,1); bode(H1.Si, '-', H2.Si, '--');
```

```
subplot(2,2,2); bode(H1.Ti,'- ',H2.Ti,'-- ');
subplot(2,2,3); bode(H1.PSi,'- ',H2.PSi,'-- ');
subplot(2,2,4); bode(H1.CSo,'- ',H2.CSo,'-- ');
```

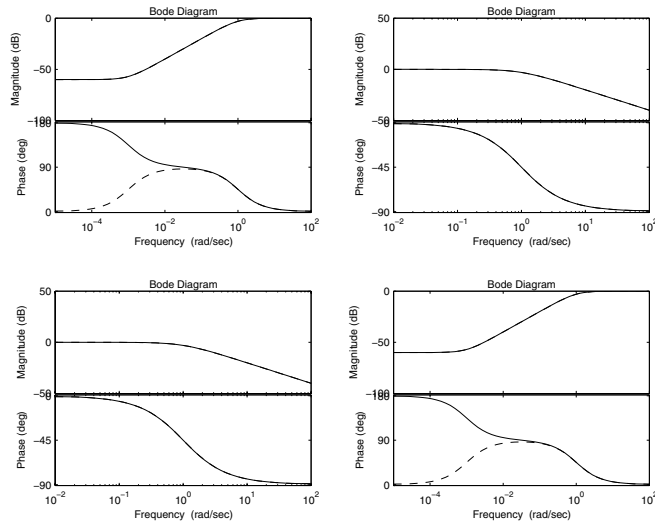

Next, consider two stable plant models that differ by a first order system. One plant is the transfer function  $50/(s+50)$  and the other plant is the transfer function  $50/(s+50) * 8/(s+8)$ .

```
p3 = tf([50],[1 50]);
p4 = tf([8],[1 8])*p3;
```

Although the two systems have similar high frequency dynamics, the same unity gain at low frequency, the plants are modestly *far* apart in the gap and nugap metrics.

```
[g,ng] = gapmetric(p3,p4)
g =
    0.6156
ng =
    0.6147
```

**Algorithm**

gap and nugap compute the gap and v gap metrics between two LTI objects. Both quantities give a numerical value  $\delta(p_0, p_1)$  between 0 and 1 for the distance between a nominal system  $p_0$  ( $G_0$ ) and a perturbed system  $p_1$  ( $G_1$ ). The gap metric was introduced into the control literature by Zames and El-Sakkary, 1980, and exploited by Georgiou and Smith, 1990. The v gap metric was derived by Vinnicombe, 1993. For both of these metrics the following robust performance result holds from Qui and Davidson, 1992, and Vinnicombe, 1993

$$\arcsin b(G_1, K_1) \geq \arcsin b(G_0, K_0) - \arcsin \delta(G_0, G_1) - \arcsin \delta(K_0, K_1)$$

where

$$b(G, K) = \left\| \begin{bmatrix} I \\ K \end{bmatrix} (I - GK)^{-1} \begin{bmatrix} G & I \end{bmatrix} \right\|_{\infty}^{-1}$$

The interpretation of this result is that if a nominal plant  $G_0$  is stabilized by controller  $K_0$ , with “stability margin”  $b(G_0, K_0)$ , then the stability margin when  $G_0$  is perturbed to  $G_1$  and  $K_0$  is perturbed to  $K_1$  is degraded by no more than the above formula. Note that  $1/b(G, K)$  is also the signal gain from disturbances on the plant input and output to the input and output of the controller. The v gap is always less than or equal to the gap, so its predictions using the above robustness result are tighter.

To make use of the gap metrics in robust design, weighting functions need to be introduced. In the above robustness result,  $G$  needs to be replaced by  $W_2 G W_1$  and  $K$  by  $W_1^{-1} K W_2^{-1}$  (similarly for  $G_0$ ,  $G_1$ ,  $K_0$  and  $K_1$ ). This makes the weighting functions compatible with the weighting structure in the  $H_{\infty}$ -loop shaping control design procedure (see loopsyn and ncfsyn for more details).

The computation of the gap amounts to solving 2-block  $H_{\infty}$  problems, Georgiou, Smith 1988. The particular method used here for solving the  $H_{\infty}$  problems is based on Green et al., 1990. The computation of the nugap uses the method of Vinnicombe, 1993.

**Reference**

Georgiou, T.T., On the computation of the gap metric, *Systems Control Letters*, vol. 11, pp. 253–257, 1988.

Georgiou, T.T., and M. Smith, "Optimal robustness in the gap metric," *IEEE Transactions on Automatic Control*, vol. 35, pp. 673–686, 1990.

Green, M., K. Glover, D. Limebeer, and J.C. Doyle, "A J-spectral factorization approach to  $H_\infty$  control," *SIAM J. of Control and Opt.*, 28(6), pp. 1350–1371, 1990.

Qiu, L., and E.J. Davison, "Feedback stability under simultaneous gap metric uncertainties in plant and controller," *Systems Control Letters*, vol. 18–1, pp. 9–22, 1992.

Vinnicombe, G., "Measuring Robustness of Feedback Systems," PhD dissertation, Department of Engineering, University of Cambridge, 1993.

Zames, G., and El-Sakkary, "Unstable systems and feedback: The gap metric," *Proceedings of the Allerton Conference*, pp. 380–385, Oct., 1980.

## See Also

|            |                                                      |
|------------|------------------------------------------------------|
| loopmargin | Comprehensive analysis of feedback loop              |
| loopsyn    | $H_\infty$ - loop shaping controller synthesis       |
| ncfsyn     | $H_\infty$ - normalized coprime controller synthesis |
| robuststab | Calculate stability margins of uncertain systems     |
| wcsens     | Calculate worst-case sensitivities for feedback loop |
| wcmargin   | Calculate worst-case margins for feedback loop       |



|                    |                                                                                                                                                                                                                                                                                                                                                             |
|--------------------|-------------------------------------------------------------------------------------------------------------------------------------------------------------------------------------------------------------------------------------------------------------------------------------------------------------------------------------------------------------|
| <b>Purpose</b>     | Fit single-input/single-output magnitude data with a real, rational, minimum phase transfer function                                                                                                                                                                                                                                                        |
| <b>Syntax</b>      | <code>resp = genphase(d)</code>                                                                                                                                                                                                                                                                                                                             |
| <b>Description</b> | <code>genphase</code> uses the complex-cepstrum algorithm to generate a complex frequency response, <code>resp</code> , whose magnitude is equal to the real, positive response <code>d</code> , but whose phase corresponds to a stable, minimum phase function. The input, <code>d</code> , and output, <code>resp</code> , are <code>frd</code> objects. |
| <b>Reference</b>   | Oppenheim, A.V., and R.W. Schaffer, <i>Digital Signal Processing</i> , Prentice Hall, New Jersey, 1975, pp. 513.                                                                                                                                                                                                                                            |
| <b>See Also</b>    | <code>fitmagfrd</code> Fitting magnitude data with stable LTI model                                                                                                                                                                                                                                                                                         |

# getlmi

---

**Purpose** Get the internal description of an LMI system

**Syntax** `lmysys = getlmi`

**Description** After completing the description of a given LMI system with `lmivar` and `lmiterm`, its internal representation `lmysys` is obtained with the command

```
lmysys = getlmi
```

This MATLAB representation of the LMI system can be forwarded to the LMI solvers or any other LMI-Lab function for subsequent processing.

|                 |                      |                                                |
|-----------------|----------------------|------------------------------------------------|
| <b>See Also</b> | <code>setlmi</code>  | Initialize the description of an LMI system    |
|                 | <code>lmivar</code>  | Specify the matrix variables in an LMI problem |
|                 | <code>lmiterm</code> | Specify the term content of LMIs               |
|                 | <code>newlmi</code>  | Attach an identifying tag to LMIs              |

|                    |                                                                         |
|--------------------|-------------------------------------------------------------------------|
| <b>Purpose</b>     | Generalized eigenvalue minimization under LMI constraints               |
| <b>Syntax</b>      | <code>[lopt,xopt] = gevp(lmisys,nlfc,options,linit,xinit,target)</code> |
| <b>Description</b> | gevp solves the generalized eigenvalue minimization problem             |

Minimize  $\lambda$  subject to:

$$\mathcal{A}(x) < \mathcal{D}(x) \quad (10-9)$$

$$0 < \mathcal{B}(x) \quad (10-10)$$

$$\mathcal{A}(x) < \lambda \mathcal{B}(x) \quad (10-11)$$

where  $\mathcal{C}(x) < \mathcal{D}(x)$  and  $\mathcal{A}(x) < \lambda \mathcal{B}(x)$  denote systems of LMIs. Provided that (9-11)–(9-12) are jointly feasible, `gevp` returns the global minimum `lopt` and the minimizing value `xopt` of the vector of decision variables  $x$ . The corresponding optimal values of the matrix variables are obtained with `dec2mat`.

The argument `lmisys` describes the system of LMIs (9-11)–(9-13) for  $\lambda = 1$ . The LMIs involving  $\lambda$  are called the *linear-fractional constraints* while (9-11)–(9-12) are regular LMI constraints. The number of linear-fractional constraints (9-13) is specified by `nlfc`. All other input arguments are optional. If an initial feasible pair  $(\lambda_0, x_0)$  is available, it can be passed to `gevp` by setting `linit` to  $\lambda_0$  and `xinit` to  $x_0$ . Note that `xinit` should be of length `decnbr(lmisys)` (the number of decision variables). The initial point is ignored when infeasible. Finally, the last argument `target` sets some target value for  $\lambda$ . The code terminates as soon as it has found a feasible pair  $(\lambda, x)$  with  $\lambda \geq \text{target}$ .

**Caution** When setting up your `gevp` problem, be cautious to

- Always specify the linear-fractional constraints (9-13) *last* in the LMI system. `gevp` systematically assumes that the last `nlfc` LMI constraints are linear fractional
- Add the constraint  $\mathcal{B}(x) > 0$  or any other LMI constraint that enforces it (see Remark below). This positivity constraint is required for regularity and good formulation of the optimization problem.

## Control Parameters

The optional argument `options` gives access to certain control parameters of the optimization code. In `gevp`, this is a five-entry vector organized as follows:

- `options(1)` sets the desired relative accuracy on the optimal value `lopt` (default =  $10^{-2}$ ).
- `options(2)` sets the maximum number of iterations allowed to be performed by the optimization procedure (100 by default).
- `options(3)` sets the feasibility radius. Its purpose and usage are as for `feasp`.
- `options(4)` helps speed up termination. If set to an integer value  $J > 0$ , the code terminates when the progress in  $\lambda$  over the last  $J$  iterations falls below the desired relative accuracy. By progress, we mean the amount by which  $\lambda$  decreases. The default value is 5 iterations.
- `options(5) = 1` turns off the trace of execution of the optimization procedure. Resetting `options(5)` to zero (default value) turns it back on.

Setting `option(i)` to zero is equivalent to setting the corresponding control parameter to its default value.

## Example

Given

$$A_1 = \begin{pmatrix} -1 & 2 \\ 1 & -3 \end{pmatrix}, \quad A_2 = \begin{pmatrix} -0.8 & 1.5 \\ 1.3 & -2.7 \end{pmatrix}, \quad A_3 = \begin{pmatrix} -1.4 & 0.9 \\ 0.7 & -2.0 \end{pmatrix},$$

consider the problem of finding a single Lyapunov function  $V(x) = x^T P x$  that proves stability of

$$\dot{x} = A_i x \quad (i = 1, 2, 3)$$

and maximizes the decay rate  $-\frac{dV(x)}{dt}$ . This is equivalent to minimizing

$\alpha$  subject to

$$I < P \tag{10-12}$$

$$A_1^T P + P A_1 < \alpha P \tag{10-13}$$

$$A_2^T P + P A_2 < \alpha P \quad (10-14)$$

$$A_3^T P + P A_3 < \alpha P \quad (10-15)$$

To set up this problem for gevp, first specify the LMIs (9-15)–(9-17) with  $\alpha = 1$ :

```
setlmis([]);
p = lmivar(1,[2 1])

lemiterm([1 1 1 0],1) % P > I : I
lemiterm([ 1 1 1 p],1,1) % P > I : P
lemiterm([2 1 1 p],1,a1,'s') % LFC # 1 (lhs)
lemiterm([ 2 1 1 p],1,1) % LFC # 1 (rhs)
lemiterm([3 1 1 p],1,a2,'s') % LFC # 2 (lhs)
lemiterm([ 3 1 1 p],1,1) % LFC # 2 (rhs)
lemiterm([4 1 1 p],1,a3,'s') % LFC # 3 (lhs)
lemiterm([ 4 1 1 p],1,1) % LFC # 3 (rhs)
lmis = getlmis
```

Note that the linear fractional constraints are defined last as required. To minimize  $\alpha$  subject to (9-15)–(9-17), call gevp by

```
[alpha,popt]=gevp(lmis,3)
```

This returns  $\alpha = -0.122$  as optimal value (the largest decay rate is therefore 0.122). This value is achieved for

$$P = \begin{pmatrix} 5.58 & -8.35 \\ -8.35 & 18.64 \end{pmatrix}$$

### Remark

Generalized eigenvalue minimization problems involve standard LMI constraints (9-11) and linear fractional constraints (9-13). For well-posedness, the positive definiteness of  $B(x)$  must be enforced by adding the constraint  $B(x) > 0$  to the problem. Although this could be done automatically from inside the code, this is not desirable for efficiency reasons. For instance, the set of constraints (9-12) may reduce to a single constraint as in the example above. In this case, the single extra LMI “ $P > I$ ” is enough to enforce positivity of *all*

linear-fractional right-hand sides. It is therefore left to the user to devise the least costly way of enforcing this positivity requirement.

## Reference

The solver `gevp` is based on Nesterov and Nemirovski's Projective Method described in

Nesterov, Y., and A. Nemirovski, *Interior Point Polynomial Methods in Convex Programming: Theory and Applications*, SIAM, Philadelphia, 1994.

The optimization is performed by the CMEX file `fpds.mex`.

## See Also

|                      |                                                                                                 |
|----------------------|-------------------------------------------------------------------------------------------------|
| <code>dec2mat</code> | Given values of the decision variables, derive the corresponding values of the matrix variables |
| <code>decnbr</code>  | Give the total number of decision variables in a system of LMIs                                 |
| <code>feasp</code>   | Find a solution to a given system of LMIs                                                       |
| <code>mincx</code>   | Minimize a linear objective under LMI constraints                                               |

|                    |                                                                                                                                                                                                                                                                                                                                                                                                                                                                                                                                                                                                                                                                                                                                                                                                                                                                                                                                                                                                                                                                                                                                                                                                                                                                                                                                                                                                                                                                                                                                     |
|--------------------|-------------------------------------------------------------------------------------------------------------------------------------------------------------------------------------------------------------------------------------------------------------------------------------------------------------------------------------------------------------------------------------------------------------------------------------------------------------------------------------------------------------------------------------------------------------------------------------------------------------------------------------------------------------------------------------------------------------------------------------------------------------------------------------------------------------------------------------------------------------------------------------------------------------------------------------------------------------------------------------------------------------------------------------------------------------------------------------------------------------------------------------------------------------------------------------------------------------------------------------------------------------------------------------------------------------------------------------------------------------------------------------------------------------------------------------------------------------------------------------------------------------------------------------|
| <b>Purpose</b>     | Grid ureal parameters uniformly over their range                                                                                                                                                                                                                                                                                                                                                                                                                                                                                                                                                                                                                                                                                                                                                                                                                                                                                                                                                                                                                                                                                                                                                                                                                                                                                                                                                                                                                                                                                    |
| <b>Syntax</b>      | <pre> B = gridreal(A,N) [B,SampleValues] = gridreal(A,N) [B,SampleValues] = gridreal(A,Names,N) [B,SampleValues] = gridreal(A,Names1,N1,Names2,N2,...) </pre>                                                                                                                                                                                                                                                                                                                                                                                                                                                                                                                                                                                                                                                                                                                                                                                                                                                                                                                                                                                                                                                                                                                                                                                                                                                                                                                                                                       |
| <b>Description</b> | <p><code>B = gridureal(A,N)</code> substitutes <code>N</code> uniformly-spaced samples of the uncertain real parameters in <code>A</code>. The size of array <code>B</code> is equal to <code>[size(A) N]</code>. The <code>N</code> samples are generated by uniformly gridding each <code>ureal</code> in <code>A</code> across its range. If <code>A</code> includes uncertain objects other than <code>ureal</code>, then <code>B</code> will be an uncertain object.</p> <p><code>[B,SampleValues] = gridureal(A,N)</code> additionally returns the specific sampled values (as a <code>STRUCT</code> whose fieldnames are the names of <code>A</code>'s uncertain elements) of the uncertain reals. Hence, <code>B</code> is the same as <code>usubs(A,SampleValues)</code>.</p> <p><code>[B,SampleValues] = gridureal(A,NAMES,N)</code> samples only the uncertain reals listed in the <code>NAMES</code> variable (<code>CELL</code>, or <code>CHAR</code> array). Any entries of <code>NAMES</code> that are not elements of <code>A</code> are ignored. Note that <code>gridureal(A,fieldnames(A.Uncertainty),N)</code> is the same as <code>gridureal(A,N)</code>.</p> <p><code>[B,SampleValues] = gridureal(A,NAMES1,N1,NAMES2,N2,...)</code> takes <code>N1</code> samples of the uncertain real parameters listed in <code>NAMES1</code>, and <code>N2</code> samples of the uncertain real parameters listed in <code>NAMES2</code> and so on. <code>size(B)</code> will equal <code>[size(A) N1 N2 ...]</code>.</p> |
| <b>Example</b>     | <p>Create two uncertain real parameters <code>gamma</code> and <code>tau</code>. The nominal value of <code>gamma</code> is 4 and its range is 3 to 5. The nominal value of <code>tau</code> is 0.5 and its value can change by +/- 30 percent.</p> <pre> gamma = ureal('gamma',4); tau = ureal('tau',.5,'Percentage',30); </pre> <p>These uncertain parameters are used to construct an uncertain transfer function <code>p</code>. An integral controller, <code>c</code>, is synthesized for the plant <code>p</code> based on the nominal values of <code>gamma</code> and <code>tau</code>. The uncertain closed-loop system, <code>c1p</code>, is formed.</p> <pre> p = tf(gamma,[tau 1]); </pre>                                                                                                                                                                                                                                                                                                                                                                                                                                                                                                                                                                                                                                                                                                                                                                                                                             |

```
KI = 1/(2*tau.Nominal*gamma.Nominal);  
c = tf(KI,[1 0]);  
clp = feedback(p*c,1);
```

The figure below shows the open-loop unit step response (top plot) and closed-loop response (bottom plot) for a grid of 20 values of  $\gamma$  and  $\tau$ .

```
subplot(2,1,1); step(gridureal(p,20),6)  
title('Open-loop plant step responses')  
subplot(2,1,2); step(gridureal(clp,20),6)
```

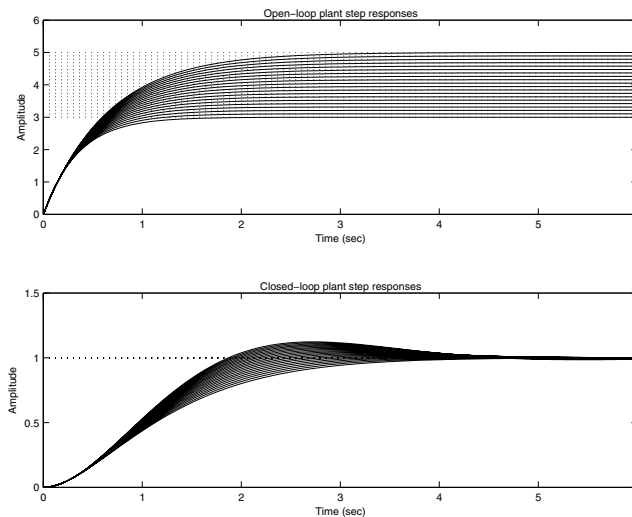

Clearly this illustrates the low-frequency closed-loop insensitivity achieved by the PI control system.

## More detailed example

The next example illustrates the different options in gridding high-dimensional (e.g.,  $n$  greater than 2) parameter spaces. An uncertain matrix,  $m$ , is constructed from four uncertain real parameters,  $a$ ,  $b$ ,  $c$  and  $d$ , each making up the individual entries.

```
a=ureal('a',1); b=ureal('b',2); c=ureal('c',3); d=ureal('d',4);
```



```
m = [a b;c d];
```

In the first case, the (a, b) space is gridded at five places, and the (c, d) space at 3 places, The uncertain matrix m is evaluated at these 15 “grid”-points resulting in the matrix m1.

```
m1 = gridureal(m,{'a';'b'},5,{'c';'d'},3);
```

In the second case, the (a, b, c, d) space is gridded at 15 places, and the uncertain matrix m is sampled at these 15 points. The resulting matrix is m2.

```
m2 = gridureal(m,{'a';'b';'c';'d'},15);
```

The (2,1) entry of m is just the uncertain real parameter c. Below, you see the histogram plots of the (2,1) entry of both m1 and m2. The (2,1) entry of m1 only takes on 3 distinct values, while the (2,1) entry of m2 (which is also c) takes on 15 distinct values uniformly through its range.

```
subplot(2,1,1)
hist(m1(2,1,:))
title('2,1 entry of m1')
subplot(2,1,2)
hist(m2(2,1,:))
```

```
title('2,1 entry of m2')
```

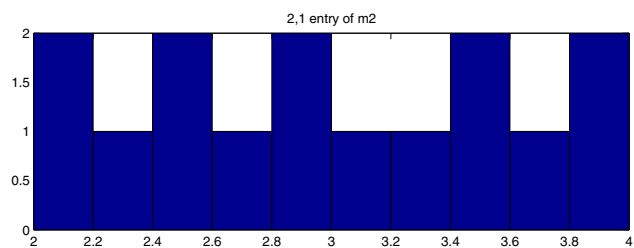
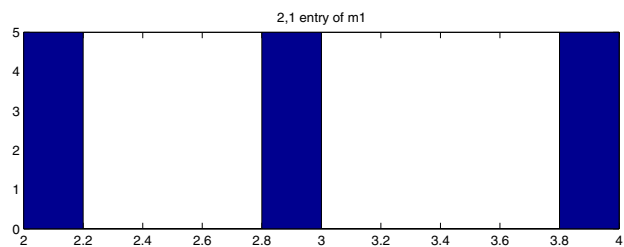

## See Also

`usample`  
`usubs`

Generates random samples of an atom  
Substitutes values for atoms

**Purpose** Mixed  $H_2/H_\infty$  synthesis with pole placement constraints

**Syntax** `[gopt,h2opt,K,R,S] = hinfmix(P,r,obj,region,dkbnd,tol)`

**Description** h2hinfyn performs multi-objective output-feedback synthesis. The control problem is sketched in this figure.

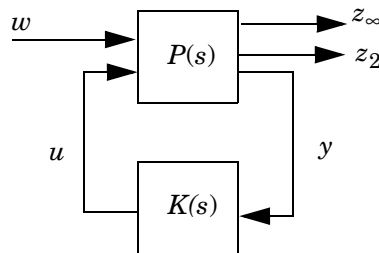

**Figure 10-4: Mixed  $H_2/H_\infty$  synthesis**

If  $T_\infty(s)$  and  $T_2(s)$  denote the closed-loop transfer functions from  $w$  to  $z_\infty$  and  $z_2$ , respectively, hinfmix computes a suboptimal solution of the following synthesis problem:

Design an LTI controller  $K(s)$  that minimizes the mixed  $H_2/H_\infty$  criterion

$$\alpha \|T_\infty\|_\infty^2 + \beta \|T_2\|_2^2$$

subject to

- $\|T_\infty\|_\infty < \gamma_0$
- $\|T_2\|_2 < \nu_0$
- The closed-loop poles lie in some prescribed LMI region  $D$ .

Recall that  $\|\cdot\|_\infty$  and  $\|\cdot\|_2$  denote the  $H_\infty$  norm (RMS gain) and  $H_2$  norm of transfer functions. More details on the motivations and statement of this problem can be found in “Multi-Objective H• Synthesis” on page 5-15.

$P$  is any SS, TF, or ZPK LTI representation of the plant  $P(s)$ , and  $r$  is a three-entry vector listing the lengths of  $z_2$ ,  $y$ , and  $u$ . Note that  $z_\infty$  and/or  $z_2$  can be empty. The four-entry vector  $obj = [\gamma_0, \nu_0, \alpha, \beta]$  specifies the  $H_2/H_\infty$

constraints and trade-off criterion, and the remaining input arguments are optional:

- region specifies the LMI region for pole placement (the default region = [] is the open left-half plane). Use `lmireg` to interactively build the LMI region description region
- `dkbnd` is a user-specified bound on the norm of the controller feedthrough matrix  $D_K$ . The default value is 100. To make the controller  $K(s)$  strictly proper, set `dkbnd` = 0.
- `tol` is the required relative accuracy on the optimal value of the trade-off criterion (the default is  $10^{-2}$ ).

The function `h2hinfsyn` returns guaranteed  $H_\infty$  and  $H_2$  performances `gopt` and `h2opt` as well as the SYSTEM matrix `K` of the LMI-optimal controller. You can also access the optimal values of the LMI variables  $R$ ,  $S$  via the extra output arguments `R` and `S`.

A variety of mixed and unmixed problems can be solved with `hinfmix`. In particular, you can use `hinfmix` to perform pure pole placement by setting `obj` = [0 0 0 0]. Note that both  $z_\infty$  and  $z_2$  can be empty in such case.

## Reference

Chilali, M., and P. Gahinet, “ $H_\infty$  Design with Pole Placement Constraints: An LMI Approach,” to appear in *IEEE Trans. Aut. Contr.*, 1995.

Scherer, C., “Mixed  $H_2 H_\infty$  Control,” to appear in *Trends in Control: A European Perspective*, volume of the special contributions to the ECC 1995.

## See Also

`lmireg`  
`msfsyn`

Specify LMI regions for pole placement purposes  
Multi-model/multi-objective state-feedback synthesis

**Purpose**  $H_2$  control synthesis for an LTI plant

**Syntax** `[K,CL,GAM,INFO]=H2SYN(P,NMEAS,NCON)`

**Description** h2syn computes a stabilizing  $H_2$  optimal LTI/SS controller  $K$  for a partitioned LTI plant  $P$ . The controller,  $K$ , stabilizes the plant  $P$  and has the same number

$$P = \left[ \begin{array}{c|cc} A & B_1 & B_2 \\ \hline C_1 & D_{11} & D_{12} \\ C_2 & D_{21} & D_{22} \end{array} \right]$$

of states as  $P$ . The LTI system  $P$  is partitioned where inputs to  $B_1$  are the disturbances, inputs to  $B_2$  are the control inputs, output of  $C_1$  are the errors to be kept small, and outputs of  $C_2$  are the output measurements provided to the controller.  $B_2$  has column size (NCON) and  $C_2$  has row size (NMEAS).

If  $P$  is constructed with `mktito`, you can omit `NMEAS` and `NCON` from the arguments.

The closed-loop system is returned in `CL` and the achieved  $H_2$  cost  $\gamma$  in `GAM`. — see Figure 2. `INFO` is a `STRUCT` array that returns additional information about the design.

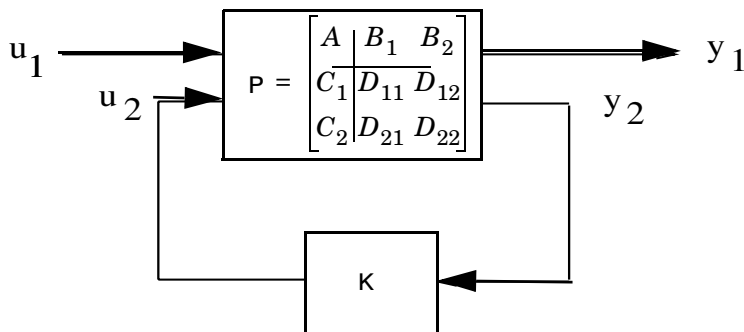

**Figure 10-5:  $H_2$  control system**  $CL = \text{lft}(P, K) = T_{y_1 u_1}$ .

|                   |                                                    |
|-------------------|----------------------------------------------------|
| Output arguments: |                                                    |
| K                 | LTI controller                                     |
| CL= lft(P,K)      | LTI closed-loop system $T_{y_1u_1}$                |
| GAM = norm(CL)    | the $H_2$ optimal cost $\gamma = \ T_{y_1u_1}\ _2$ |
| INFO              | additional output information                      |

Additional output — structure array INFO containing possible additional information depending on METHOD):

|            |                                                                                                                                                                                    |
|------------|------------------------------------------------------------------------------------------------------------------------------------------------------------------------------------|
| INFO.NORMS | norms of 4 different quantities, full information control cost (FI), output estimation cost (OEF), direct feedback cost (DFL) and full control cost (FC). NORMS = [FI OEF DFL FC]; |
| INFO.KFI   | full-information gain matrix (constant feedback)<br>$u_2(t) = K_{FI}x(t)$                                                                                                          |
| INFO.GFI   | full-information closed-loop system<br>GFI=ss(A-B2*KFI,B1,C1-D12*KFI,D11)                                                                                                          |
| INFO.HAMX  | X Hamiltonian matrix (state-feedback)                                                                                                                                              |
| INFO.HAMY  | Y Hamiltonian matrix (Kalman filter)                                                                                                                                               |

## Examples

**Example 1:** Stabilize 4-by-5 unstable plant with 3-states, NMEAS=2, NCON=2

```
rand('seed',0);randn('seed',0);
P=rss(3,4,5)';
[K,CL,GAM]=h2syn(P,2,1);
open_loop_poles=pole(P)
closed_loop_poles=pole(CL)
```

**Example 2:** Mixed-Sensitivity  $H_2$  loop-shaping. Here the goal is to shape the sigma plots of sensitivity  $S:=(I+GK)^{-1}$  and complementary sensitivity  $T:=GK(I+GK)^{-1}$ , by choosing a stabilizing  $K$  that minimizes the  $H_2$  norm of

$$T_{y_1 u_1} \triangleq \begin{bmatrix} W_1 S \\ (W_2/G)T \\ W_3 T \end{bmatrix}$$

where  $G(s) = \frac{s-1}{s-2}$ ,  $W_1 = \frac{0.1(s+1000)}{100s+1}$ ,  $W_2 = 0.1$ , no  $W_3$ .

```
s=zpk('s');
G=10*(s-1)/(s+1)^2;
W1=0.1*(s+100)/(100*s+1); W2=0.1; W3=[];
P=(G,W1,W2,W3);
[K,CL,GAM]=h2syn(P);
L=G*K; S=inv(1+L); T=1-S;
sigma(L,'k-.',S,'r',T,'g')
```

## Algorithm

The  $H_2$  optimal control theory has its roots in the frequency domain interpretation the cost function associated with time-domain state-space LQG control theory [1]. The equations and corresponding nomenclature used here are taken from the Doyle *et al.*, 1989 [2]-[3].

h2syn solves the  $H_2$  optimal control problem by observing that it is equivalent to a conventional Linear-Quadratic Gaussian (LQG) optimal control problem. For simplicity, we shall describe the details of algorithm only for the continuous-time case, in which case the cost function  $J_{LQG}$  satisfies

$$\begin{aligned}
 J_{LQG} &= \lim_{T \rightarrow \infty} E \left\{ \frac{1}{T} \int_0^T y_1^T y_1 dt \right\} \\
 &= \lim_{T \rightarrow \infty} E \left\{ \frac{1}{T} \int_0^T [x^T \ u_2^T] \begin{bmatrix} Q & N_c \\ N_c^T & R \end{bmatrix} \begin{bmatrix} x \\ u_2 \end{bmatrix} dt \right\} \\
 &= \lim_{T \rightarrow \infty} E \left\{ \frac{1}{T} \int_0^T [x^T \ u_2^T] \begin{bmatrix} C_1^T \\ D_{12}^T \end{bmatrix} [C_1 \ D_{12}] \begin{bmatrix} x \\ u_2 \end{bmatrix} dt \right\}
 \end{aligned}$$

with plant noise  $u_1$  channel of intensity I, passing through the matrix  $[B_1;0;D_{12}]$  to produce equivalent white correlated with plant  $\xi$  and white measurement noise  $\theta$  having joint correlation function

$$\begin{aligned}
 E \left\{ \begin{bmatrix} \xi(t) \\ \theta(t) \end{bmatrix} \begin{bmatrix} \xi(\tau) & \theta(\tau) \end{bmatrix}^T \right\} &= \begin{bmatrix} \Xi & N_f \\ N_f^T & \Theta \end{bmatrix} \delta(t - \tau) \\
 &= \begin{bmatrix} B_1 \\ D_{21} \end{bmatrix} \begin{bmatrix} B_1^T & D_{21}^T \end{bmatrix} \delta(t - \tau)
 \end{aligned}$$

The  $H_2$  optimal controller  $K(s)$  is thus realizable in the usual LQG manner as a full-state feedback  $K_{FF}$  and a Kalman filter with residual gain matrix  $K_{FC}$ .

## 1 Kalman Filter

$$\hat{x} = A\hat{x} + B_2 u_2 + K_{FC}(y_2 - C_2 \hat{x} - D_{22} u_2)$$

$$K_{FC} = (YC_2^T + N_f)\Theta^{-1} = (YC_2^T + B_1 D_{21}^T)(D_{21} D_{21}^T)^{-1}$$

where  $Y = Y^T \geq 0$  solves the Kalman filter Riccati equation

$$YA^T + AY - (YC_2^T + N_f)\Theta^{-1}(C_2 Y + N_f^T) + \Xi = 0$$



## 2 Full-State Feedback

$$u_2 = K_{FI} \hat{x}$$

$$K_{FI} = R^{-1} (B_2^T X + N_c^T) = (D_{12}^T D_{12})^{-1} (B_2^T X + D_{12}^T C_1)$$

where  $X = X^T \geq 0$  solves the state-feedback Riccati equation

$$A^T X + XA - (XB_2 + N_c) R^{-1} (B_2^T X + N_c^T) + Q = 0$$

The final *positive-feedback*  $H_2$  optimal controller  $u_2 = K(s)y_2$  has a familiar closed-form

$$K(s) := \left[ \begin{array}{c|c} A - K_{FC} C_2 - B_2 K_{FI} + K_{FC} D_{22} K_{FI} & K_f \\ \hline -K_{FI} & 0 \end{array} \right]$$

h2syn implements the continuous optimal  $H_2$  control design computations using the formulae described in the Doyle, *et al.* [2]; for discrete-time plants, h2syn uses the same controller formula, except that the corresponding discrete time Riccati solutions (dare) are substituted for  $X$  and  $Y$ . A Hamiltonian is formed and solved via a Riccati equation. In the continuous-time case, the optimal  $H_2$ -norm is infinite when the plant  $D_{11}$  matrix associated with the input disturbances and output errors is *non-zero*; in this case, the optimal  $H_2$  controller returned by h2syn is computed by first setting  $D_{11}$  to zero.

## 3 Optimal Cost GAM.

The full information (FI) cost is given by the equation  $(\text{trace}(B_1' X_2 B_1))^{1/2}$ . The

output estimation cost (OEF) is given by  $(\text{trace}(F_2 Y_2 F_2'))^{1/2}$ , where

$F_2 = -(B_2' X_2 + D_{12}' C_1)$ . The disturbance feedforward cost (DFL) is

$(\text{trace}(L_2' X_2 L_2))^{1/2}$ , where  $L_2$  is defined by  $-(Y_2 C_2' + B_1 D_{21}')$  and the full control

cost (FC) is given by  $(\text{trace}(C_1 Y_2 C_1'))^{1/2}$ .  $X_2$  and  $Y_2$  are the solutions to the  $X$  and  $Y$  Riccati equations, respectively. For for continuous-time plants with zero feedthrough term ( $D_{11} = 0$ ), and for all discrete-time plants, the optimal  $H_2$  cost

$\gamma = \|T_{y_1 u_1}\|_2$  is

$$\text{GAM} = \sqrt{F\mathbf{I}^2 + \mathbf{O}E\mathbf{F}^2 + \text{trace}(\mathbf{D}_{11}*\mathbf{D}_{11}')} ;$$
  
otherwise,  $\text{GAM} = \text{Inf} .$

## Limitations

- 1  $(A, B_2, C_2)$  must be *stabilizable and detectable*.
- 2  $D_{12}$  must have full column rank and  $D_{21}$  must have full row rank

## References

- [1] Safonov, M. G., A. J. Laub, and G. Hartmann, "Feedback Properties of Multivariable Systems: The Role and Use of Return Difference Matrix," *IEEE Trans. of Automat. Contr.*, AC-26, pp. 47-65, 1981.
- [2] Doyle, J. C., K. Glover, P. Khargonekar, and B. Francis, "State-space solutions to standard  $H_2$  and  $H_\infty$  control problems," *IEEE Transactions on Automatic Control*, vol. 34, no. 8, pp. 831–847, August 1989.
- [3] Glover, K., and J.C. Doyle, "State-space formulae for all stabilizing controllers that satisfy an  $H_\infty$  norm bound and relations to risk sensitivity," *Systems and Control Letters*, 1988. vol. 11, pp. 167–172, August 1989.

## See Also

|         |                                          |
|---------|------------------------------------------|
| augw    | Augment plant weights for control design |
| hinfsyn | $H_\infty$ synthesis controller          |

**Purpose** Hankel Minimum Degree Approximation (MDA) without balancing

**Syntax**

```
GRED = hankelmr(G)
GRED = hankelmr(G,order)
[GRED,redinfo] = hankelmr(G,key1,value1,...)
[GRED,redinfo] = hankelmr(G,order,key1,value1,...)
```

**Description** `hankelmr` returns a reduced order model `GRED` of `G` and a struct array `redinfo` containing the error bound of the reduced model and Hankel singular values of the original system.

The error bound is computed based on Hankel singular values of `G`. For a stable system Hankel singular values indicate the respective state energy of the system. Hence, reduced order can be directly determined by examining the system Hankel SV's,  $\sigma$ .

With only one input argument `G`, the function will show a Hankel singular value plot of the original model and prompt for model order number to reduce.

This method guarantees an error bound on the infinity norm of the *additive error*  $\|G - GRED\|_{\infty}$  for well-conditioned model reduced problems [1]:

$$\|G - Gred\|_{\infty} \leq 2 \sum_{k+1}^n \sigma_i$$

---

**Note** It seems this method is similar to the additive model reduction routines `balancmr` and `schurmr`, but actually it can produce more reliable reduced order model when the desired reduced model has nearly controllable and/or observable states (has Hankel singular values close to machine accuracy). `hankelmr` will then select an optimal reduced system to satisfy the error bound criterion regardless the order one might naively select at the beginning.

---

This table describes input arguments for `hankelmr`.

| Argument | Description                                                                                                                        |
|----------|------------------------------------------------------------------------------------------------------------------------------------|
| G        | LTI model to be reduced (without any other inputs will plot its Hankel singular values and prompt for reduced order)               |
| ORDER    | (Optional) an integer for the desired order of the reduced model, or optionally a vector packed with desired orders for batch runs |

A batch run of a serial of different reduced order models can be generated by specifying `order = x:y`, or a vector of integers. By default, all the anti-stable part of a system is kept, because from control stability point of view, getting rid of unstable state(s) is dangerous to model a system.

'*MaxError*' can be specified in the same fashion as an alternative for 'ORDER'. In this case, reduced order will be determined when the sum of the tails of the Hankel sv's reaches the '*MaxError*'.

| Argument   | Value                                     | Description                                                                                                                    |
|------------|-------------------------------------------|--------------------------------------------------------------------------------------------------------------------------------|
| 'MaxError' | Real number or vector of different errors | Reduce to achieve $H^\infty$ error. When present, ' <i>MaxError</i> ' overrides ORDER input.                                   |
| 'Weights'  | {Wout,Win} cell array                     | Optimal 1x2 cell array of LTI weights Wout (output) and Win (input). Default for both is identity. Weights must be invertible. |
| 'Display'  | 'on' or 'off'                             | Display Hankel singular plots (default 'off').                                                                                 |
| 'Order'    | Integer, vector or cell array             | Order of reduced model. Use only if not specified as 2nd argument.                                                             |

Weights on the original model input and/or output can make the model reduction algorithm focus on some frequency range of interests. But weights have to be stable, minimum phase and invertible.

This table describes output arguments.

| Argument | Description                                                                                                                                                                                                                                                                                                                                           |
|----------|-------------------------------------------------------------------------------------------------------------------------------------------------------------------------------------------------------------------------------------------------------------------------------------------------------------------------------------------------------|
| GRED     | LTI reduced order model. Become multi-dimensional array when input is a serial of different model order array.                                                                                                                                                                                                                                        |
| REDINFO  | A STRUCT array with 4 fields: <ul style="list-style-type: none"> <li>• REDINFO.ErrorBound (bound on <math>\ G - G_{\text{GRED}}\ _{\infty}</math>)</li> <li>• REDINFO.StabSV (Hankel SV of stable part of G)</li> <li>• REDINFO.UnstabSV (Hankel SV of unstable part of G)</li> <li>• REDINFO.Ganticausal (Anti-causal part of Hankel MDA)</li> </ul> |

G can be stable or unstable, continuous or discrete.

---

**Note** If `size(GRED)` is not equal to the order you specified. The optimal Hankel MDA algorithm has selected the best Minimum Degree Approximate it can find within the allowable machine accuracy.

---

## Algorithm

Given a state-space  $(A, B, C, D)$  of a system and  $k$ , the desired reduced order, the following steps will produce a similarity transformation to truncate the original state space system to the  $k^{\text{th}}$  order reduced model.

- 1 Find the controllability and observability grammians  $P$  and  $Q$ .
- 2 Form the descriptor

$$E = QP - \rho^2 I$$

where  $\sigma_k > \rho \geq \sigma_{k+1}$ , and descriptor state-space

$$\left[ \begin{array}{c|c} E_s - \bar{A} & \bar{B} \\ \hline \bar{C} & \bar{D} \end{array} \right] = \left[ \begin{array}{c|c} \rho^2 A^T + QAP & QB \\ \hline CP & D \end{array} \right]$$

Take SVD of descriptor  $E$  and partition the result into  $k^{th}$  order truncation form

$$E = [U_{E1}, U_{E2}] \begin{bmatrix} \Sigma_E & 0 \\ 0 & 0 \end{bmatrix} \begin{bmatrix} V_{E1}^T \\ V_{E2}^T \end{bmatrix}$$

**3** Apply the transformation to the descriptor state-space system above we have

$$\begin{bmatrix} A_{11} & A_{12} \\ A_{21} & A_{22} \end{bmatrix} = \begin{bmatrix} U_{E1}^T \\ U_{E2}^T \end{bmatrix} (\rho^2 A^T + QAP) \begin{bmatrix} V_{E1} & V_{E2} \end{bmatrix}$$

$$\begin{bmatrix} B_1 \\ B_2 \end{bmatrix} = \begin{bmatrix} U_{E1}^T \\ U_{E2}^T \end{bmatrix} \begin{bmatrix} QB & -C^T \end{bmatrix}$$

$$\begin{bmatrix} C_1 & C_2 \end{bmatrix} = \begin{bmatrix} CP \\ -\rho B^T \end{bmatrix} \begin{bmatrix} V_{E1} & V_{E2} \end{bmatrix}$$

$$D_1 = D$$

- 4** Form the equivalent state-space model.
- 5** The final  $k^{th}$  order Hankel MDA is the stable part of the above state-space realization. Its anticausal part is stored in `redinfo.Ganticausal`.

$$\begin{bmatrix} \tilde{A} & \tilde{B} \\ \tilde{C} & \tilde{D} \end{bmatrix} = \begin{bmatrix} \Sigma_E^{-1}(A_{11} - A_{12}A_{22}^\dagger A_{21}) & \Sigma_E^{-1}(B_1 - A_{12}A_{22}^\dagger B_2) \\ C_1 - C_2A_{22}^\dagger A_{21} & D_1 - C_2A_{22}^\dagger B_2 \end{bmatrix}$$

The proof of the Hankel MDA algorithm can be found in [2]. The error system between the original system  $G$  and the *Zeroth Order Hankel MDA*  $G_0$  is an all-pass function [1].

### Example

Given a continuous or discrete, stable or unstable system,  $G$ , the following commands can get a set of reduced order models based on your selections:

```
rand('state',1234); randn('state',5678);G = rss(30,5,4);
[g1, redinfo1] = hankelmr(G); % display Hankel SV plot
                                % and prompt for order (try 15:20)
[g2, redinfo2] = hankelmr(G,20);
[g3, redinfo3] = hankelmr(G,[10:2:18]);
[g4, redinfo4] = hankelmr(G,'MaxError',[0.01, 0.05]);
rand('state',12345); randn('state',6789);
wt1 = rss(6,5,5); wt1.d = eye(5)*2;
wt2 = rss(6,4,4); wt2.d = 2*eye(4);
[g5, redinfo5] = hankelmr(G, [10:2:18], 'weight',{wt1,wt2});
for i = 1:5
    figure(i); eval(['sigma(G,g' num2str(i) ');']);
end
```

Figure 10-6, Singular Value Bode Plot of  $G$  (30-state, 5 outputs, 4 inputs), on page 10-110 shows a singular value Bode plot of a random system  $G$  with 20 states, 5 output and 4 inputs. The error system between  $G$  and its *Zeroth order Hankel MDA* has its infinity norm equals to an all pass function, as shown in Figure 10-7, All-Pass Error System Between  $G$  and Zeroth Order  $G$  Anticausal, on page 10-111 (ref.: [5]).

The *Zeroth order Hankel MDA* and its error system  $\sigma$  plot are obtained via commands

```
[g0,redinfo0] = hankelmr(G,0);
sigma(G-redinfo0.Ganticausal)
```

This interesting all-pass property is unique in Hankel MDA model reduction.

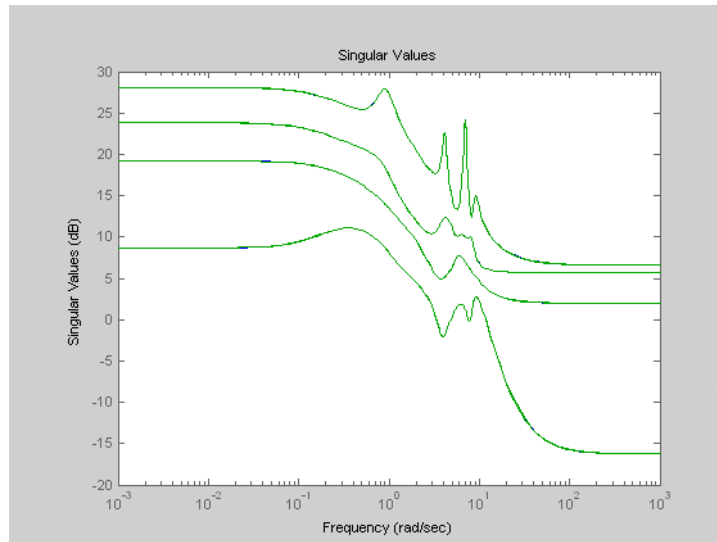

**Figure 10-6: Singular Value Bode Plot of G (30-state, 5 outputs, 4 inputs)**



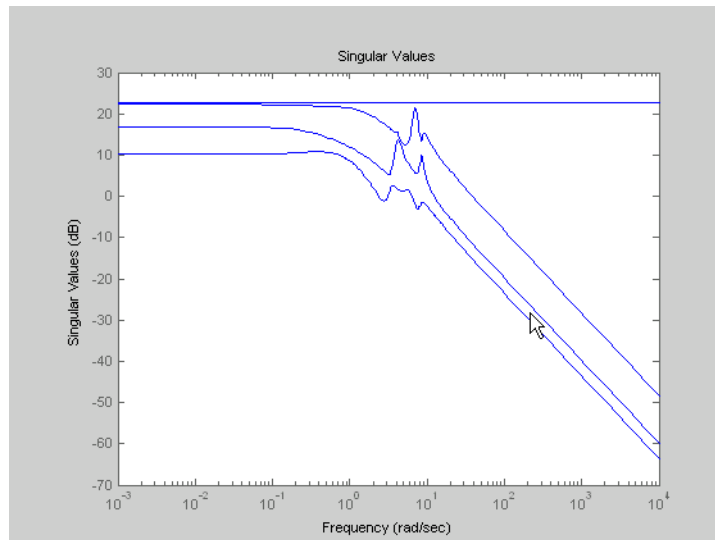

**Figure 10-7: All-Pass Error System Between  $G$  and Zeroth Order  $G$  Anticausal**

## Reference

- [1] Glover K. "All Optimal Hankel Norm Approximation of Linear Multivariable Systems, and Their  $L_\infty$  - error Bounds," *Int. J. Control*, vol. 39, no. 6, pp. 1145-1193, 1984.
- [2] Safonov M. G. and R. Y. Chiang, and D. J. N. Limebeer, "Optimal Hankel Model Reduction for Nonminimal Systems," *IEEE Trans. on Automat. Contr.*, vol. 35, no. 4, April 1990, pp. 496-502.

## See Also

|          |                                                    |
|----------|----------------------------------------------------|
| reduce   | Top level model reduction routines                 |
| balancmr | Balanced truncation via square-root method         |
| schurmr  | Balanced truncation via Schur method               |
| bstmr    | Balanced stochastic truncation via Schur method    |
| ncfmr    | Balanced truncation for normalized coprime factors |
| hankelsv | Hankel singular value                              |

# hankelsv

**Purpose** Compute Hankel singular values for stable/unstable or continuous/discrete system

**Syntax**  
hankelsv(G)  
hankelsv(G,ErrorType,style)  
[sv\_stab,sv\_unstab]=hankelsv(G,ErrorType,style)

**Description** [sv\_stab,sv\_unstab]=hankelsv(G,ErrorType,style) returns a column vector SV\_STAB containing the Hankel singular values of the stable part of G and SV\_UNSTAB of anti-stable part (if it exists). The Hankel SV's of anti-stable part  $ss(a, b, c, d)$  is computed internally via  $ss(-a, -b, c, d)$ . Discrete model is converted to continuous one via the bilinear transform.

hankelsv(G) with no output arguments draws a bar graph of the Hankel singular values such as the following:

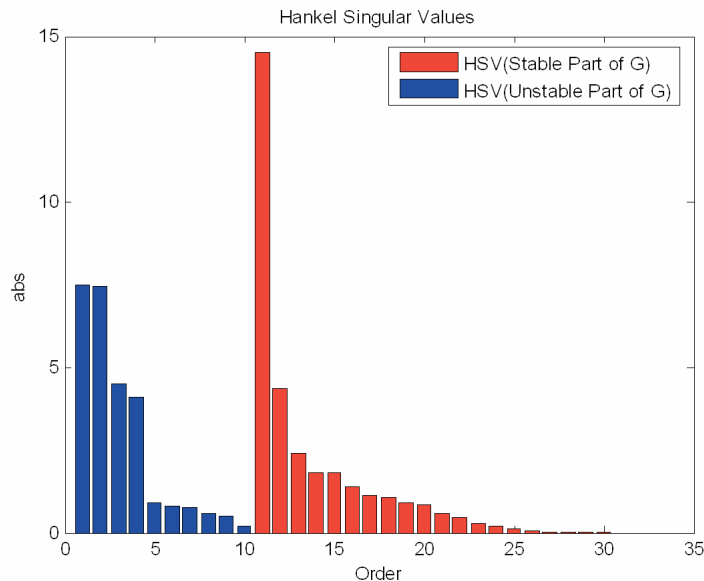

This table describes optional input arguments for `hankelsvd`.

| Argument  | Value                    | Description                                                                               |
|-----------|--------------------------|-------------------------------------------------------------------------------------------|
| ERRORTYPE | 'add'<br>'mult'<br>'ncf' | Regular Hankel SV's of G<br>Hankel SV's of phase matrix<br>Hankel SV's of coprime factors |
| STYLE     | 'abs'<br>'log'           | Absolute value<br>logarithm scale                                                         |

## Algorithm

For `ErrorType = 'add'`, `hankelsv` implements the numerically robust square root method to compute the Hankel singular values [1]. Its algorithm goes as follows:

Given a stable model  $G$ , with controllability and observability grammians  $P$  and  $Q$ , compute the SVD of  $P$  and  $Q$ :

$$\begin{aligned} [U_p, S_p, V_p] &= \text{svd}(P); \\ [U_q, S_q, V_q] &= \text{svd}(Q); \end{aligned}$$

Then form the square roots of the grammians:

$$\begin{aligned} L_r &= U_p \cdot \text{diag}(\sqrt{\text{diag}(S_p)}); \\ L_o &= U_q \cdot \text{diag}(\sqrt{\text{diag}(S_q)}); \end{aligned}$$

The Hankel singular values are simply:

$$\sigma_H = \text{svd}(L_o' * L_r);$$

This method not only takes the advantages of robust SVD algorithm, but also ensure the computations stay well within the “square root” of the machine accuracy.

For `ErrorType = 'mult'`, `hankelsv` computes the Hankel singular value of the phase matrix of  $G$  [2].

For `ErrorType = 'ncf'`, `hankelsv` computes the Hankel singular value of the normalized coprime factor pair of the model [3].

## Reference

- [1] Safonov M. G. and R. Y. Chiang, "A Schur Method for Balanced Model Reduction," *IEEE Trans. on Automat. Contr.*, vol. AC-2, no. 7, July 1989, pp. 729-733.
- [2] Safonov M. G. and R. Y. Chiang, "Model Reduction for Robust Control: A Schur Relative Error Method," *International J. of Adaptive Control and Signal Processing*, Vol. 2, pp. 259-272, 1988.
- [3] Vidyasagar M. *Control System Synthesis - A Factorization Approach*. London: The MIT Press, 1985.

## See Also

|          |                                                    |
|----------|----------------------------------------------------|
| reduce   | Top level model reduction routines                 |
| balancmr | Balanced truncation via square-root method         |
| schurmr  | Balanced truncation via Schur method               |
| bstmr    | Balanced stochastic truncation via Schur method    |
| ncfmr    | Balanced truncation for normalized coprime factors |
| hankelmr | Hankel minimum degree approximation                |

**Purpose** Synthesis of gain-scheduled  $H_\infty$  controllers

**Syntax** `[gopt,pdK,R,S] = hinfgs(pdP,r,gmin,tol,tolred)`

**Description** Given an affine parameter-dependent plant

$$P \begin{cases} \dot{x} &= A(p)x + B_1(p)w + B_2u \\ z &= C_1(p)x + D_{11}(p)w + D_{12}u \\ y &= C_2x + D_{21}w + D_{22}u \end{cases}$$

where the time-varying parameter vector  $p(t)$  ranges in a box and is measured in real time, `hinfgs` seeks an affine parameter-dependent controller

$$K \begin{cases} \dot{\zeta} &= A_K(p)\zeta + B_K(p)y \\ u &= C_K(p)\zeta + D_K(p)y \end{cases}$$

scheduled by the measurements of  $p(t)$  and such that

- $K$  stabilizes the closed-loop system

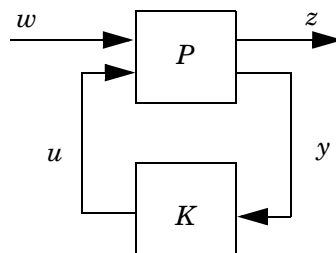

for all admissible parameter trajectories  $p(t)$

- $K$  minimizes the closed-loop quadratic  $H_\infty$  performance from  $w$  to  $z$ .

The description `pdP` of the parameter-dependent plant  $P$  is specified with `psys` and the vector `r` gives the number of controller inputs and outputs (set `r=[p2,m2]` if  $y \in \mathbf{R}^{p2}$  and  $u \in \mathbf{R}^{m2}$ ). Note that `hinfgs` also accepts the polytopic model of  $P$  returned, e.g., by `aff2po1`.

`hinfgs` returns the optimal closed-loop quadratic performance `gopt` and a polytopic description of the gain-scheduled controller `pdK`. To test if a

closed-loop quadratic performance  $\gamma$  is achievable, set the third input `gmin` to  $\gamma$ . The arguments `tol` and `tolred` control the required relative accuracy on `gopt` and the threshold for order reduction. Finally, `hinfgs` also returns solutions  $R$ ,  $S$  of the characteristic LMI system.

## Controller Implementation

The gain-scheduled controller `pdK` is parametrized by  $p(t)$  and characterized by

the values  $K_{\Pi_j}$  of  $\begin{pmatrix} A_K(p) & B_K(p) \\ C_K(p) & D_K(p) \end{pmatrix}$  at the corners  $^3_j$  of the parameter box. The

command

```
Kj = psinfo(pdK, 'sys', j)
```

returns the  $j$ -th vertex controller  $K_{\Pi_j}$  while

```
pv = psinfo(pdP, 'par')
vertx = polydec(pv)
Pj = vertx(:, j)
```

gives the corresponding corner  $^3_j$  of the parameter box (`pv` is the parameter vector description).

The controller scheduling should be performed as follows. Given the measurements  $p(t)$  of the parameters at time  $t$ ,

- 6 Express  $p(t)$  as a convex combination of the  $^3_j$ :

$$p(t) = \alpha_1^3_1 + \dots + \alpha_N^3_N, \quad \alpha_j \geq 0, \quad \sum_{i=1}^N \alpha_i = 1$$

This convex decomposition is computed by `polydec`.

- 7 Compute the controller state-space matrices at time  $t$  as the convex combination of the vertex controllers  $K_{\Pi_j}$ :

$$\begin{pmatrix} A_K(t) & B_K(t) \\ C_K(t) & D_K(t) \end{pmatrix} = \sum_{i=1}^N \alpha_i K_{\Pi_i}$$

- 8 Use  $A_K(t)$ ,  $B_K(t)$ ,  $C_K(t)$ ,  $D_K(t)$  to update the controller state-space equations.

**Reference**

Apkarian, P., P. Gahinet, and G. Becker, “Self-Scheduled  $H_\infty$  Control of Linear Parameter-Varying Systems,” submitted to *Automatica*, October 1995.

Becker, G., Packard, P., “Robust Performance of Linear-Parametrically Varying Systems Using Parametrically-Dependent Linear Feedback,” *Systems and Control Letters*, 23 (1994), pp. 205–215.

Packard, A., “Gain Scheduling via Linear Fractional Transformations,” *Syst. Contr. Letters*, 22 (1994), pp. 79–92.

**See Also**

|         |                                                                                  |
|---------|----------------------------------------------------------------------------------|
| psys    | Specification of uncertain state-space models                                    |
| pvec    | Quantification of uncertainty on physical parameters                             |
| pdsimul | Time response of a parameter-dependent system along a given parameter trajectory |
| polydec | Compute polytopic coordinates wrt. box corners                                   |

# hinfsyn

**Purpose** Compute an  $H_\infty$  optimal controller for an LTI plant

**Syntax**

```
[K,CL,GAM,INFO] = hinfsyn(P)
[K,CL,GAM,INFO] = hinfsyn(P,NMEAS,NCON)
[K,CL,GAM,INFO] = hinfsyn(P,NMEAS,NCON,KEY1,VALUE1,KEY2,VALUE2,...)
```

**Description** hinfsyn computes a stabilizing  $H_\infty$  optimal LTI/SS controller K for a partitioned LTI plant P.

$$P = \left[ \begin{array}{c|cc} A & B_1 & B_2 \\ \hline C_1 & D_{11} & D_{12} \\ C_2 & D_{21} & D_{22} \end{array} \right]$$

The controller, K, stabilizes the P and has the same number of states as P. The SYSTEM P is partitioned where inputs to  $B_1$  are the disturbances, inputs to  $B_2$  are the control inputs, output of  $C_1$  are the errors to be kept small, and outputs of  $C_2$  are the output measurements provided to the controller.  $B_2$  has column size (NCON) and  $C_2$  has row size (NMEAS). The optional KEY and VALUE inputs determine tolerance, solution method and so forth—see Figure 1 for details.

The closed-loop system is returned in CL and the achieved  $H_\infty$  cost  $\gamma$  in GAM. INFO is a STRUCT array that returns additional information about the design—see Figure 2.

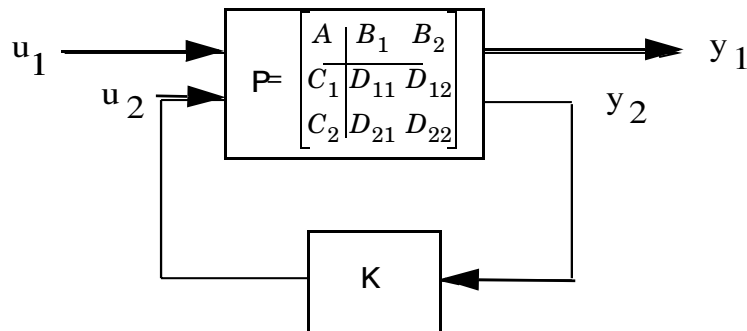

**Figure 10-8:**  $H_\infty$  control system  $CL = \text{lft}(P, K) = T_{y_1 u_1}$ .



| Key       | Value         | Meaning                                                                                        |
|-----------|---------------|------------------------------------------------------------------------------------------------|
| 'GMAX'    | real          | initial upper bound on GAM (default=Inf)                                                       |
| 'GMIN'    | real          | initial lower bound on GAM (default=0)                                                         |
| 'TOLGAM'  | real          | relative error tolerance for GAM (default=.01)                                                 |
| 'S0'      | real          | (default=Inf) frequency S0 at which entropy is evaluated, only applies to METHOD 'maxe'        |
| 'METHOD'  | 'ric'         | (default) standard 2-Riccati solution,                                                         |
|           | 'lmi'         | LMI solution                                                                                   |
|           | 'maxe'        | maximum entropy solution                                                                       |
| 'DISPLAY' | 'off'<br>'on' | (default) no command window display, or command window displays synthesis progress information |

**Figure 10-9: Optional input arguments (KEY, VALUE) pairs**

When DISPLAY= 'on', the hinfsyn program displays several variables indicating the progress of the algorithm. For each  $\gamma$  value being tested, the minimum magnitude, real part of the eigenvalues of the X and Y Hamiltonian matrices are displayed along with the minimum eigenvalue of  $X_\infty$  and  $Y_\infty$ , which are the solutions to the X and Y Riccati equations, respectively. The maximum eigenvalue of  $X_\infty Y_\infty$ , scaled by  $\gamma^{-2}$ , is also displayed. A # sign is placed to the right of the condition that failed in the printout

.

|                   |                                      |
|-------------------|--------------------------------------|
| Output arguments: |                                      |
| K                 | LTI controller                       |
| CL= lft(P,K)      | LTI closed-loop system $T_{y_1 u_1}$ |

|                     |                                                                |
|---------------------|----------------------------------------------------------------|
| GAM = norm(CL, Inf) | the $\mathbf{H}_\infty$ cost $\gamma = \ T_{y_1 u_1}\ _\infty$ |
| INFO                | additional output information                                  |

Additional output — structure array INFO containing possible additional information depending on METHOD):

|            |                                                                                                                   |
|------------|-------------------------------------------------------------------------------------------------------------------|
| INFO.AS    | all solutions controller, LTI two-port LFT                                                                        |
| INFO.KFI   | full information gain matrix (constant feedback<br>$u_2(t) = K_{FI} \begin{bmatrix} x(t) \\ u_1(t) \end{bmatrix}$ |
| INFO.KFC   | full control gain matrix (constant output-injection; $K_{FC}$ is the dual of $K_{FI}$ )                           |
| INFO.GAMFI | $\mathbf{H}_\infty$ cost for full information $K_{FI}$                                                            |
| INFO.GAMFC | $\mathbf{H}_\infty$ cost for full control $K_{FC}$                                                                |

## Algorithm

The default 'ric' method uses the two-riccati formulae ([4],[5]) with loopshifting [6]. In the case of the 'lmi' method, hinfsyn employs the LMI technique ([7],[8],[9]). With 'METHOD' 'maxe', K returns the max entropy  $\mathbf{H}_\infty$  controller that minimize an entropy integral relating to the point  $s_0$ ; i.e.,

$$\text{Entropy} = -\frac{\gamma^2}{2\pi} \int_{-\infty}^{\infty} \ln \left| \det I - \gamma^{-2} T_{y_1 u_1}(j\omega)' T_{y_1 u_1}(j\omega) \right| \left[ \frac{s_0^2}{s_0^2 + \omega^2} \right] d\omega$$

where  $T_{y_1 u_1}$  is the closed-loop transfer function CL. With all methods, hinfsyn uses a standard  $\gamma$ -iteration technique to determine the optimal value of  $\gamma$ . Starting with high and low estimates of  $\gamma$ . The  $\gamma$ -iteration is a *bisection algorithm* that iterates on the value of  $\gamma$  in an effort to approach the optimal  $\mathbf{H}_\infty$  control design. The stopping criterion for the bisection algorithm requires the relative difference between the last  $\gamma$  value that failed and the last  $\gamma$  value that passed be less than TOLGAM (default=.01)

At each value of  $\gamma$ , the algorithm employed requires tests to determine whether a solution exists for a given  $\gamma$  value. In the case of the 'ric' method, the conditions checked for the existence of a solution are:

- $H$  and  $J$  Hamiltonian matrices (which are formed from the state-space data of  $P$  and the  $\gamma$  level) must have no imaginary-axis eigenvalues.
- the stabilizing Riccati solutions  $X_\infty$  and  $Y_\infty$  associated with the Hamiltonian matrices must exist and be positive, semi-definite.
- spectral radius of  $(X_\infty, Y_\infty)$  must be less than or equal to  $\gamma^2$ .

When, DISPLAY is 'on', the hinfsyn program displays several variables, which indicate which of the above conditions are satisfied for each  $\gamma$  value being tested. In the case of the default 'ric' method, the display includes the current value of  $\gamma$  being tested, real part of the eigenvalues of the  $X$  and  $Y$  Hamiltonian matrices along with the minimum eigenvalue of  $X_\infty$  and  $Y_\infty$ , which are the solutions to the  $X$  and  $Y$  Riccati equations, respectively. The maximum eigenvalue of  $X_\infty Y_\infty$ , scaled by  $\gamma^{-2}$ , is also displayed. A # sign is placed to the right of the condition that failed in the printout. A similar DISPLAY is produced with method 'lmi'

The algorithm works best when the following conditions are satisfied by the plant:

- $D_{12}$  and  $D_{21}$  have full rank.
- $\begin{bmatrix} A - j\omega I & B_2 \\ C_1 & D_{12} \end{bmatrix}$  has full column rank for all  $\omega \in \mathbf{R}$ .
- $\begin{bmatrix} A - j\omega I & B_1 \\ C_2 & D_{21} \end{bmatrix}$  has full row rank for all  $\omega \in \mathbf{R}$ .

When the above rank conditions do not hold, the controller may have undesirable properties: If  $D_{12}$  and  $D_{21}$  are not full rank, the  $\mathbf{H}_\infty$  controller  $\mathbf{K}$  may have large high-frequency gain. If either of the latter two rank conditions does not hold at some frequency  $\omega$ , the controller may have very lightly damped poles near that frequency  $\omega$ .

In general, the solution to the infinity-norm optimal control problem is non-unique. Whereas the  $K$  returned by `hinfsyn` is only a particular  $F(s)$ , when the 'ric' method is selected, the `INFO.AS` field of `INFO` give you in addition the all- solution controller parameterization  $K_{AS}(s)$  such that all solutions to the infinity-norm control problem are parameterized by a free stable contraction map  $U(s)$  constrained by  $(\|U(s)\|_\infty < 1)$  (see Figure 5-9); that is, every

stabilizing controller  $K(s)$  that makes  $\|T_{y_1 u_1}\|_\infty \stackrel{\Delta}{=} \sup_{\omega} \sigma_{max}(T_{y_1 u_1}(j\omega)) < \gamma$

$$K = \text{lft}(INFO.AS, U)$$

where  $U$  is a stable LTI system satisfying  $\text{norm}(U, \text{Inf}) < 1$ .

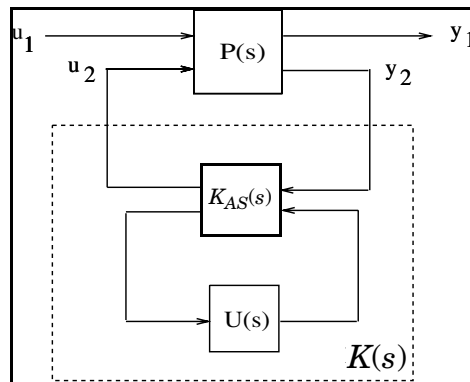

**Figure 10-10: All-solution  $K_{AS}(s)$  returned by `INFO.AS`**

An important use of the infinity-norm control theory is for direct shaping of closed-loop singular value Bode plots of control systems. In such cases, the system  $P(s)$  will typically be the plant augmented with suitable loop-shaping filters — see `andmixsyn`.

**Examples**

Following are three simple problems solved via hifsyn.

**Example 1:** A random 4-by-5 plant with 3-states, NMEAS=2, NCON=2

```
rand('seed',0);randn('seed',0);
P=rss(3,4,5);
[K,CL,GAM]=hifsyn(P,2,2);
```

The optimal  $H_\infty$  cost in this case is GAM=0.2641. You verify

that  $\|T_{y_1 u_1}\|_\infty \stackrel{\Delta}{=} \sup_{\omega} \sigma_{max}(T_{y_1 u_1}(j\omega)) < \gamma$  with a sigma plot  
`sigma(CL,ss(GAM));`

**Example 2:** Mixed-Sensitivity  $G(s) = \frac{s-1}{s-2}$ ,  $W_1 = \frac{0.1(s+1000)}{100s+1}$ ,  $W_2 = 0.1$ ,  
 no  $W_3$ .

```
s=zpk('s');
G=(s-1)/(s+1);
W1=0.1*(s+100)/(100*s+1); W2=0.1; W3=[];
P=(G,W1,W2,W3);
[K,CL,GAM]=hifsyn(P);
sigma(CL,ss(GAM));
```

In this case, GAM = 0.1854 = -14.6386 db

**Example 3:** Mixed sensitivity with  $W_1$  removed.

```
s=zpk('s');
G=(s-1)/(s+1);
W1=[]; W2=0.1; W3=[];
P=(G,W1,W2,W3);
[K,CL,GAM]=hifsyn(P)
```

In this case, GAM=0, K=0, and CL=K\*(1+G\*K)=0.

**Limitation**

The plant must be stabilizable from the control inputs  $u_2$  and detectable from the measurement output  $y_2$ :

- $(A,B_2)$  must be stabilizable and  $(C_2,A)$  must be detectable.

Otherwise, an the hifsyn returns an error.

## References

- [4] Glover, K., and J.C. Doyle, "State-space formulae for all stabilizing controllers that satisfy an  $H_\infty$  norm bound and relations to risk sensitivity," *Systems and Control Letters*, vol. 11, pp. 167–172, 1988.
- [5] Doyle, J.C., K. Glover, P. Khargonekar, and B. Francis, "State-space solutions to standard  $H_2$  and  $H_\infty$  control problems," *IEEE Transactions on Automatic Control*, vol. 34, no. 8, pp. 831–847, August 1989
- [6] M. G. Safonov, D. J. N. Limebeer and R. Y. Chiang, "Simplifying the  $H^\infty$  Theory via Loop Shifting, Matrix Pencil and Descriptor Concepts", *Int. J. Contr.*, vol. 50, no. 6, pp. 2467-2488, 1989.
- [7] A. Packard, K. Zhou, P. Pandey, J. Leonhardson, and G. Balas, "Optimal, constant I/O similarity scaling for full-information and state-feedback problems," *Systems and Control Letters*, 19:271–280, 1992.
- [8] P. Gahinet and P. Apkarian, "A linear matrix inequality approach to  $H_1$ -control," *Int J. Robust and Nonlinear Control*, 4(4):421–448, July–August 1994.
- [9] T. Iwasaki and R. E. Skelton, "All controllers for the general  $H_\infty$ -control problem: LMI existence conditions and state space formulas," *Automatica*, 30(8):1307–1317, August 1994.

## See Also

|         |                                                      |
|---------|------------------------------------------------------|
| augw    | Augments plant weights for control design            |
| h2syn   | $H_2$ synthesis controller                           |
| loopsyn | $H_\infty$ - loop shaping controller synthesis       |
| mktito  | 2-input 2-output partition of a USS object           |
| ncfsyn  | $H_\infty$ - normalized coprime controller synthesis |

**Purpose** Creates empty iconnect (interconnection) objects

**Syntax** H = iconnect

**Description** Interconnection objects (class iconnect) are an alternate to sysic, and are used to build complex interconnections of uncertain matrices and systems.

An iconnect object has 3 fields to be set by the user, 'Input', 'Output' and 'Equation'. 'Input' and 'Output' are icsignal objects, while 'Equation'.is a cell-array of equality constraints (using equate) on icsignal objects. Once these are specified, then the 'System' property is the input/output model, implied by the constraints in 'Equation'. relating the variables defined in 'Input' and 'Output'.

**Example** iconnect can be used to create the transfer matrix M as described in the following figure.

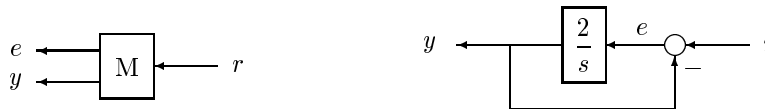

Create three scalar icsignal's, r, e and y. Create an empty iconnect object. Define the output of the interconnection to be [e; y], and the input to be r. Define two constraints among the variables: e = r-y, and y = (2/s) e. Get the transfer function representation of the relationship between the input (r) and the output [e; y].

```
r = icsignal(1);
e = icsignal(1);
y = icsignal(1);
M = iconnect;
M.Input = r;
M.Output = [e;y];
M.Equation{1} = equate(e,r-y);
M.Equation{2} = equate(y,tf(2,[1 0])*e);
tf(M.System)
```

The transfer functions from input to outputs are

$$\begin{array}{l} \text{\#1: } \frac{s}{s + 2} \end{array}$$

$$\begin{array}{l} \text{\#2: } \frac{2}{s + 2} \end{array}$$

By not explicitly introducing  $e$ , this can be done more concisely with only one equality constraint.

```
r = icsignal(1);
y = icsignal(1);
N = iconnect;
N.Input = r;
N.Output = [r-y;y];
N.Equation{1} = equate(y,tf(2,[1 0])*(r-y));
tf(N.System)
```

You have created the same transfer functions from input to outputs.

$$\begin{array}{l} \text{\#1: } \frac{s}{s + 2} \end{array}$$

$$\begin{array}{l} \text{\#2: } \frac{2}{s + 2} \end{array}$$

You can also specify uncertain, multivariable interconnections using `iconnect`.

Consider two uncertain motor/generator constraints among 4 variables  $[V;I;T;W]$ ,  $V-R*I-K*W=0$ , and  $T=K*I$ . Find the uncertain 2x2 matrix  $B$  so that  $[V;T] = B*[W;I]$ .

```
R = ureal('R',1,'Percentage',[-10 40]);
K = ureal('K',2e-3,'Percentage',[-30 30]);
V = icsignal(1);
I = icsignal(1);
T = icsignal(1);
W = icsignal(1);
M = iconnect;
M.Input = [W;I];
```



```

M.Output = [V;T];
M.Equation{1} = equate(V-R*I-K*W,iczero(1));
M.Equation{2} = equate(T,K*I);
B = M.System
UMAT: 2 Rows, 2 Columns
    K: real, nominal = 0.002, variability = [-30 30]%, 2 occurrences
    R: real, nominal = 1, variability = [-10 40]%, 1 occurrence
B.NominalValue
ans =
    0.0020    1.0000
         0    0.0020

```

A simple system interconnection, identical to the system illustrated in the sysic reference pages. Consider a three-input, two-output SYSTEM matrix  $T$ ,

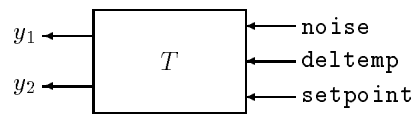

which has internal structure

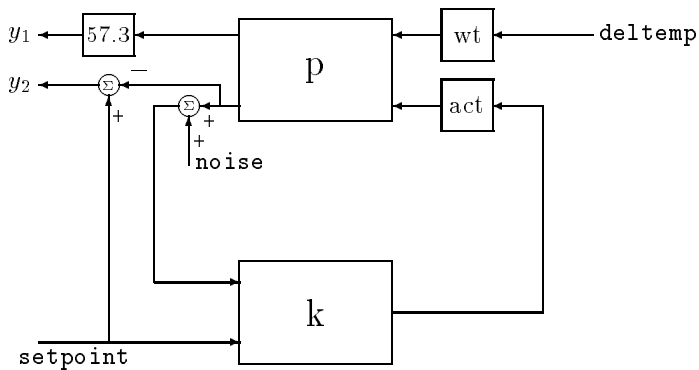

```

P = rss(3,2,2);
K = rss(1,1,2);
A = rss(1,1,1);
W = rss(1,1,1);
M = iconnect;
noise = icsignal(1);

```

```
deltemp = icsignal(1);
setpoint = icsignal(1);
yp = icsignal(2);
rad2deg = 57.3
rad2deg =
    57.3000
M.Equation{1} =
equate(yp,P*[W*deltemp;A*K*[noise+yp(2);setpoint]]);
M.Input = [noise;deltemp;setpoint];
M.Output = [rad2deg*yp(1);setpoint-yp(2)];
T = M.System;
size(T)
State-space model with 2 outputs, 3 inputs, and 6 states.
```

## Algorithm

Each equation represents an equality constraint among the variables. You choose the input and output variables, the `imp2exp` function makes the implicit relationship between them explicit.

## Limitations

The syntax for `iconnect` objects and `icsignal`'s is very flexible. Without care, you can build inefficient (i.e., non-minimal) representations where the state dimension of the interconnection is greater than the sum of the state dimensions of the components. This is in contrast to `sysic`. In `sysic`, the syntax used to specify inputs to systems (the `input_to_ListedSubSystemName` variable) forces you to include each subsystem of the interconnection only once in the equations. Hence, interconnections formed with `sysic` are componentwise minimal. That is, the state dimension of the interconnection equals the sum of the state dimensions of the components.

## See Also

|                       |                                                       |
|-----------------------|-------------------------------------------------------|
| <code>equate</code>   | Equates expressions for <code>icsignal</code> objects |
| <code>icsignal</code> | Constructs an <code>icsignal</code> object            |
| <code>sysic</code>    | Constructs system interconnection                     |

**Purpose** Create an icsignal object.

**Syntax**

```
v = icsignal(n);  
v = icsignal(n, 'name');
```

**Description** icsignal creates an icsignal object, which is a symbolic column vector. The icsignal object is used with iconnect objects to specify signal constraints described by the interconnection of components.

v = icsignal(n) creates an icsignal object of vector length n. The value of n must be a nonnegative integer. icsignal objects are symbolic column vectors, used in conjunction with iconnect (interconnection) objects to specify the signal constraints described by an interconnection of components.

v = icsignal(n, name) creates an icsignal object of dimension n, with internal name identifier given by the character string argument 'name'.

**See Also**

|          |                                          |
|----------|------------------------------------------|
| iconnect | Equates expressions for icsignal objects |
| sysic    | Constructs system interconnections       |

# imp2exp

---

**Purpose** Convert an implicit linear relationship to an explicit input-output relation

**Syntax** `B = imp2exp(A,yidx,uidx)`

**Description** `B = imp2exp(A,yidx,uidx)` transforms a linear constraint between variables  $Y$  and  $U$  of the form  $A(:, [yidx; uidx]) * [Y; U] = 0$  into an explicit input/output relationship  $Y = B * U$ . The vectors `yidx` and `uidx` refer to the columns (inputs) of  $A$  as referenced by the explicit relationship for  $B$ .

The constraint matrix  $A$  may be a `DOUBLE`, `SS`, `TF`, `ZPK` and `FRD` objects as well as an uncertain object, including `UMAT`, `USS` and `UFRD`. The result  $B$  will be of the same class.

## Example

### Scalar Algebraic constraint

Consider the constraint  $4y + 7u = 0$ . Solving for  $y$  gives  $y = -1.75u$ . You form the equation using `imp2exp`

```
A = [4 7];  
Yidx = 1;  
Uidx = 2;
```

and then

```
B = imp2exp(A,Yidx,Uidx)  
B =  
    -1.7500
```

yields  $B$  equal to  $-1.75$ .

### Matrix algebraic constraint

Consider two motor/generator constraints among 4 variables  $[V; I; T; W]$ , namely  $[1 \ -1 \ 0 \ -2e-3; 0 \ -2e-3 \ 1 \ 0] * [V; I; T; W] = 0$ . You can find the  $2 \times 2$  matrix  $B$  so that  $[V; T] = B * [W; I]$  using `imp2exp`.

```
A = [1 -1 0 -2e-3; 0 -2e-3 1 0];  
Yidx = [1 3];  
Uidx = [4 2];  
B = imp2exp(A,Yidx,Uidx)  
B =  
    0.0020    1.0000  
         0    0.0020
```

You can find the 2x2 matrix C so that  $[I;W] = C*[T;V]$

```
Yidx = [2 4];
Uidx = [3 1];
C = imp2exp(A,Yidx,Uidx)
C =
    500      0
 -250000  500
```

**Uncertain matrix algebraic constraint**

Consider two uncertain motor/generator constraints among 4 variables  $[V;I;T;W]$ , namely  $[1 -R 0 -K;0 -K 1 0]*[V;I;T;W] = 0$ . You can find the uncertain 2x2 matrix B so that  $[V;T] = B*[W;I]$ .

```
R = ureal('R',1,'Percentage',[-10 40]);
K = ureal('K',2e-3,'Percentage',[-30 30]);
A = [1 -R 0 -K;0 -K 1 0];
Yidx = [1 3];
Uidx = [4 2];
B = imp2exp(A,Yidx,Uidx)
UMAT: 2 Rows, 2 Columns
K: real, nominal = 0.002, variability = [-30 30]%, 2 occurrences
R: real, nominal = 1, variability = [-10 40]%, 1 occurrence
```

**Scalar dynamic system constraint**

Consider a standard single-loop feedback connection of controller C and an uncertain plant P, described by the equations  $e=r-y$ ,  $u=Ce$ ;  $f=d+u$ ;  $y=Pf$ .

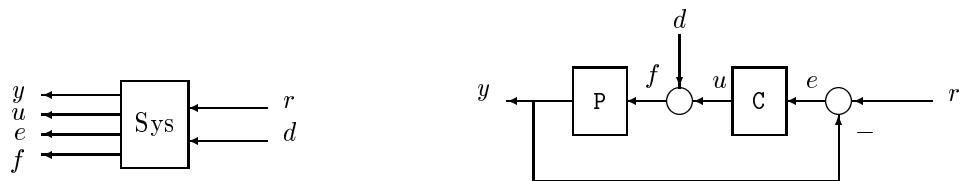

```
P = tf([1],[1 0]);
C = tf([2*.707*1 1^2],[1 0]);
A = [1 -1 0 0 0 -1;0 -C 1 0 0 0;0 0 -1 -1 1 0;0 0 0 0 -P 1];
OutputIndex = [6;3;2;5]; % [y;u;e;f]
InputIndex = [1;4]; % [r;d]
Sys = imp2exp(A,OutputIndex,InputIndex);
```

# imp2exp

```
Sys.InputName = {'r';'d'};  
Sys.OutputName = {'y';'u';'e';'f'};  
pole(Sys)  
ans =  
    -0.7070 + 0.7072i  
    -0.7070 - 0.7072i  
step(Sys)
```

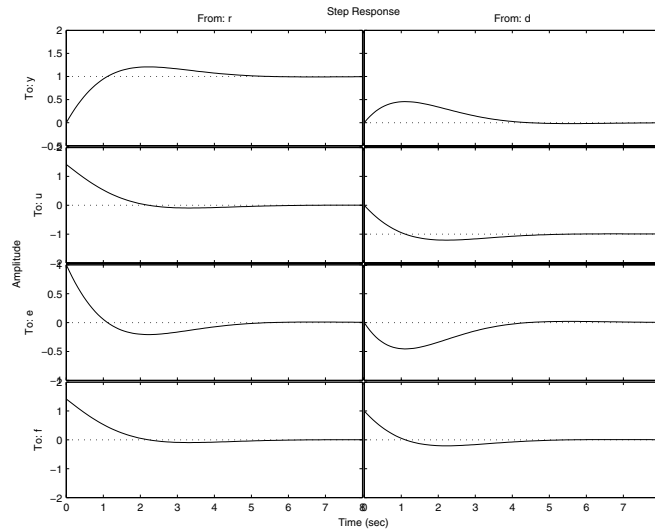

## Algorithm

The number of rows of A must equal the length of yidx.

## See Also

icconnect  
inv

Equates expressions for icsignal objects  
Forms the system inverse

**Purpose** System realization via Hankel singular value decomposition.

**Syntax**

```
[a,b,c,d,totbnd,hsv] = imp2ss(y)
[a,b,c,d,totbnd,hsv] = imp2ss(y,ts,nu,ny,tol)
[ss,totbnd,hsv] = imp2ss(imp)
[ss,totbnd,hsv] = imp2ss(imp,tol)
```

**Description** The function `imp2ss` produces an approximate state-space realization of a given impulse response

```
imp=mksys(y,t,nu,ny,'imp');
```

using the Hankel SVD method proposed by S. Kung [2]. A continuous-time realization is computed via the inverse Tustin transform (using `bilin`) if  $t$  is positive; otherwise a discrete-time realization is returned. In the SISO case the variable  $y$  is the impulse response vector; in the MIMO case  $y$  is an  $N+1$ -column matrix containing  $N+1$  time samples of the matrix-valued impulse response  $H_0, \dots, H_N$  of an  $nu$ -input,  $ny$ -output system stored row wise:

$$y = [H_0(:)'; H_1(:)'; H_2(:)'; \dots; H_N(:)']$$

The variable  $tol$  bounds the  $\mathbf{H}^\infty$  norm of the error between the approximate realization  $(a, b, c, d)$  and an exact realization of  $y$ ; the order, say  $n$ , of the realization  $(a, b, c, d)$  is determined by the infinity norm error bound specified by the input variable  $tol$ . The inputs  $ts$ ,  $nu$ ,  $ny$ ,  $tol$  are optional; if not present they default to the values  $ts = 0$ ,  $nu = 1$ ,  $ny = (\text{no. of rows of } y)/nu$ ,

$tol = 0.01\bar{\sigma}_1$ . The output  $hsv = [\bar{\sigma}_1, \bar{\sigma}_2, \dots]'$  returns the singular values (arranged in descending order of magnitude) of the Hankel matrix:

$$\Gamma = \begin{bmatrix} H_1 & H_2 & H_3 & \dots & H_N \\ H_2 & H_3 & H_4 & \dots & 0 \\ H_3 & H_4 & H_5 & \dots & 0 \\ \vdots & \vdots & \vdots & \ddots & \vdots \\ H_N & 0 & \dots & \dots & 0s \end{bmatrix}$$

Denoting by  $G_N$  a high-order exact realization of  $y$ , the low-order approximate model  $G$  enjoys the  $\mathbf{H}^\infty$  norm bound

$$\|G - G_N\|_\infty \leq \text{totbnd}$$

where

$$\text{totbnd} = 2 \sum_{i=n+1}^N \bar{\sigma}_i$$

## Algorithm

The realization  $(a, b, c, d)$  is computed using the Hankel SVD procedure proposed by Kung [2] as a method for approximately implementing the classical Hankel factorization realization algorithm. Kung's SVD realization procedure was subsequently shown to be equivalent to doing balanced truncation (`balmr`) on an exact state space realization of the finite impulse response  $\{y(1), \dots, y(N)\}$  [3]. The infinity norm error bound for discrete balanced truncation was later derived by Al-Saggaf and Franklin [1]. The algorithm is as follows:

- 1 Form the Hankel matrix  $\Gamma$  from the data  $y$ .
- 2 Perform SVD on the Hankel matrix

$$\Gamma = U\Sigma V^* = [U_1 U_2] \begin{bmatrix} \Sigma_1 & 0 \\ 0 & \Sigma_2 \end{bmatrix} \begin{bmatrix} V_1^* \\ V_2^* \end{bmatrix} = U_1 \Sigma_1 V_1^*$$

where  $\Sigma_1$  has dimension  $n \times n$  and the entries of  $\Sigma_2$  are nearly zero.  $U_1$  and  $V_1$  have  $ny$  and  $nu$  columns, respectively.

- 3 Partition the matrices  $U_1$  and  $V_1$  into three matrix blocks:

$$U_1 = \begin{bmatrix} U_{11} \\ U_{12} \\ U_{13} \end{bmatrix}; \begin{bmatrix} V_{11} \\ V_{12} \\ V_{13} \end{bmatrix}$$

where  $U_{11}, U_{13} \in C^{ny \times n}$  and  $V_{11}, V_{13} \in C^{nu \times n}$ .



4 A discrete state-space realization is computed as

$$A = \Sigma_1^{-1/2} \bar{U} \Sigma_1^{1/2}$$

$$B = \Sigma_1^{-1/2} V^*_{11}$$

$$C = U_{11} \Sigma_1^{-1/2}$$

$$D = H_0$$

where

$$\bar{U} = \begin{bmatrix} U_{11} \\ U_{12} \end{bmatrix}' \begin{bmatrix} U_{12} \\ U_{13} \end{bmatrix}$$

5 If the sampling time  $t$  is greater than zero, then the realization is converted to continuous time via the inverse of the Tustin transform

$$s = \frac{2z - 1}{tz + 1};$$

Otherwise, this step is omitted and the discrete-time realization calculated in Step 4 is returned.

## References

- [1] U. M. Al-Saggaf and G. F. Franklin, "An Error Bound for a Discrete Reduced Order Model of a Linear Multivariable System," *IEEE Trans. on Autom. Contr.*, AC-32, pp. 815-819, 1987.
- [2] S. Y. Kung, "A New Identification and Model Reduction Algorithm via Singular Value Decompositions," *Proc. Twelfth Asilomar Conf. on Circuits, Systems and Computers.*, pp. 705-714, November 6-8, 1978.
- [3] L. M. Silverman and M. Bettayeb, "Optimal Approximation of Linear Systems," *Proc. American Control Conf.*, San Francisco, CA, 1980.

# ispsys

---

**Purpose** True for parameter-dependent systems

**Syntax** `bool = ispsys(sys)`

**Description** `bool = ispsys(sys)` returns 1 if `sys` is a polytopic or parameter-dependent system.

**See Also** `psys` Specification of uncertain state-space models  
`psinfo` Inquire about polytopic or parameter-dependent systems created with `psys`

**Purpose** Checks if argument is an uncertain class type

**Syntax** `B = isuncertain(A)`

**Description** Returns true if input argument is uncertain, false otherwise. Uncertain classes are `umat`, `ufrd`, `uss`, `ureal`, `ultidyn`, `ucomplex`, `ucomplexm` and `udyn`.

**Example** In this example, you verify the correct operation of `isuncertain` on double, `ureal`, `ss` and `uss` objects.

```
isuncertain(rand(3,4))
ans =
    0
isuncertain(ureal('p',4))
ans =
    1
isuncertain(rss(4,3,2))
ans =
    0
isuncertain(rss(4,3,2)*[ureal('p1',4) 6;0 1])
ans =
    1
```

**Limitations** `isuncertain` only checks the class of the input argument, and does not actually verify that the input argument is truly uncertain. Create a `umat` by *lifting* a constant (i.e., not uncertain) matrix to the `umat` class.

```
A = umat([2 3;4 5;6 7]);
```

Note that although `A` is in class `umat`, it is not actually uncertain. Nevertheless, based on class, the result of `isuncertain(A)` is true.

```
isuncertain(A)
ans =
    1
```

The result of `simplify(A)` is a double, and hence not uncertain.

```
isuncertain(simplify(A))
ans =
```

# isuncertain

---

0

The number of rows of A must equal the length of yidx.

## See Also

`isvalid`

Checks if uncertain object is an uncertain atom

**Purpose** Decompose uncertain objects into fixed normalized and fixed uncertain parts

**Syntax**

```
[M,Delta] = lftdata(A);
[M,Delta] = lftdata(A,List);
[M,Delta,Blkstruct] = lftdata(A);
[M,Delta,Blkstruct,Normunc] = lftdata(A);
```

**Description** lftdata decomposes an uncertain object into a fixed certain part and a normalized uncertain part. lftdata can also partially decompose an uncertain object into an uncertain part, and a normalized uncertain part. Uncertain objects (umat, ufrd, uss) are represented as certain (i.e., not uncertain) objects in feedback with block-diagonal concatenations of uncertain elements.

$[M,Delta] = \text{lftdata}(A)$  separates the uncertain object  $A$  into a certain object  $M$ , and a normalized uncertain matrix  $Delta$ , such that  $A$  is equal to  $\text{lft}(Delta,M)$  as shown below.

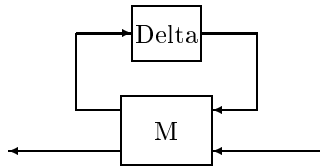

If  $A$  is a umat, then  $M$  will be double; if  $A$  is a uss, then  $M$  will be ss; if  $A$  is a ufrd, then  $M$  will be frd. In all cases,  $Delta$  is a umat.

$[M,Delta] = \text{lftdata}(A,List)$  separates the uncertain object  $A$  into an uncertain object  $M$ , in feedback with a normalized uncertain matrix  $Delta$ .  $List$  is a cell array (or char) of names of uncertain elements of  $A$  that make up  $Delta$ . All other uncertainty in  $A$  remains in  $M$ .

$\text{lftdata}(A, \text{fieldnames}(A.Uncertainty))$  is the same as  $\text{lftdata}(A)$ .

$[M,DELTA,BLKSTRUCT] = \text{LFTDATA}(A)$  returns an  $N$ -by-1 structure array  $BLKSTRUCT$ , where  $BLKSTRUCT(i)$  describes the  $i$ -th normalized uncertain element. This uncertainty description can be passed directly to the low-level structured singular value analysis function  $MUSSV$ .

$[M,DELTA,BLKSTRUCT,NORMUNC] = \text{LFTDATA}(A)$  returns the cell array  $NORMUNC$  of normalized uncertain elements. Each normalized element has the string

'Normalized' appended to its original name to avoid confusion. Note that `LFT(BLKDIAG(NORMUNC{:}),M)` is equivalent to `A`.

## Example

Create an uncertain matrix, `A`, with 3 uncertain parameters, `p1`, `p2` and `p3`. You can decompose `A` into its certain, `M`, and normalized uncertain parts, `Delta`.

```
p1 = ureal('p1', -3, 'perc', 40);
p2 = ucomplex('p2', 2);
A = [p1 p1+p2; 1 p2];
[M,Delta] = lftdata(A);
```

You can inspect the difference between the original uncertain matrix, `A`, and the result formed by combining the two results from the decomposition.

```
simplify(A-lft(Delta,M))
ans =
     0     0
     0     0
M
M =
     0     0  1.0954  1.0954
     0     0     0  1.0000
 1.0954  1.0000 -3.0000 -1.0000
     0  1.0000  1.0000  2.0000
```

You can check the worst-case norm of the uncertain part using `wcnorm`. Compare samples of the uncertain part `A` with the uncertain matrix `A`.

```
wcn = wcnorm(Delta)
wcn =
  lbound: 1.0000
  ubound: 1.0001
usample(Delta,5)
ans(:,:,1) =
  0.8012
     0
     0.2499 + 0.6946i
ans(:,:,2) =
  0.4919
     0
  0.2863 + 0.6033i
ans(:,:,3) =
 -0.1040
     0
```

```

      0          0.7322 - 0.3752i
ans(:,:,4) =
      0.8296          0
      0          0.6831 + 0.1124i
ans(:,:,5) =
      0.6886          0
      0          0.0838 + 0.3562i

```

### Uncertain Systems

Create an uncertain matrix, A, with 2 uncertain real parameters, v1 and v2 and create an uncertain system G using A as the dynamic matrix, and simple matrices for the input and output.

```

A = [ureal('p1', -3, 'perc', 40) 1; 1 ureal('p2', -2)];
sys = ss(A, [1; 0], [0 1], 0);
sys.InputGroup.ActualIn = 1;
sys.OutputGroup.ActualOut = 1;

```

You can decompose G into it a certain system, Msys, and a normalized uncertain matrix, Delta. You can see from Msys that it is certain, and the input and output groups have been adjusted.

```

[Msys, Delta] = lftdata(sys);
Msys

```

```

a =
      x1  x2
x1  -3   1
x2   1  -2

```

```

b =
      u1  u2  u3
x1  1.095  0   1
x2   0     1   0

```

```

c =
      x1  x2
y1  1.095  0
y2   0     1

```

```
      y3      0      1

d =
      u1  u2  u3
y1  0   0   0
y2  0   0   0
y3  0   0   0

Input groups:
      Name      Channels
ActualIn      3
p1_NC         1
p2_NC         2

Output groups:
      Name      Channels
ActualOut     3
p1_NC         1
p2_NC         2
```

Continuous-time model.

You can compute the norm on samples of the difference between the original uncertain matrix and the result formed by combining *Msys* and *Delta*.

```
norm(usample(sys-lft(Delta,Msys),'p1',4,'p2',3),'inf')
ans =
      0      0      0
      0      0      0
      0      0      0
      0      0      0
```

### Partial decomposition

Create an uncertain matrix, *A*, and derive an uncertain matrix *B* using an implicit-to-explicit conversion, `imp2exp`. Note that *B* has 2 uncertain parameters, *R* and *K*. You can decompose *B* into its certain, *M*, and normalized uncertain parts, *Delta*.

```
R = ureal('R',1,'Percentage',[-10 40]);
K = ureal('K',2e-3,'Percentage',[-30 30]);
```



```

A = [1 -R 0 -K;0 -K 1 0];
Yidx = [1 3];
Uidx = [4 2];
B = imp2exp(A,Yidx,Uidx);
[M,Delta] = lftdata(B);

```

The same operation can be performed by defining the uncertain parameters, K and R, to be extracted.

```

[MK,DeltaR] = lftdata(B,'R');
MK
UMAT: 3 Rows, 3 Columns
K: real, nominal = 0.002, variability = [-30 30]%, 2 occurrences
[MR,DeltaK] = lftdata(B,'K');
MR
UMAT: 4 Rows, 4 Columns
R: real, nominal = 1, variability = [-10 40]%, 1 occurrence

```

```

simplify(B-lft(Delta,M))
ans =
    0    0
    0    0
simplify(B-lft(DeltaR,MK))
ans =
    0    0
    0    0
simplify(B-lft(DeltaK,MR))
ans =
    0    0
    0    0

```

Sample and inspect the uncertain part as well as the difference between the original uncertain matrix. You can see the result formed by combining the two results from the decomposition.

```

[Mall,Deltaall] = lftdata(B,{'K';'R'});
simplify(Mall)-M
ans =
    0    0    0    0    0
    0    0    0    0    0
    0    0    0    0    0

```

# lftdata

---

0 0 0 0 0  
0 0 0 0 0

## See Also

lft

ssdata

Forms Redheffer star product of systems

Returns uncertain state-space data

|                    |                                                                                                                                                                                                                                                                                                                                                                                                                                                                                                                                                                                                                                                                                                                                                                                                                                                                                                                                                                                                                                                                                                                                                                                                                                                                                                                                                                                                                                                                                                                                                                                                                                                                                                                                                                                                                                                                                                                                                                                                                                                                                                                                         |
|--------------------|-----------------------------------------------------------------------------------------------------------------------------------------------------------------------------------------------------------------------------------------------------------------------------------------------------------------------------------------------------------------------------------------------------------------------------------------------------------------------------------------------------------------------------------------------------------------------------------------------------------------------------------------------------------------------------------------------------------------------------------------------------------------------------------------------------------------------------------------------------------------------------------------------------------------------------------------------------------------------------------------------------------------------------------------------------------------------------------------------------------------------------------------------------------------------------------------------------------------------------------------------------------------------------------------------------------------------------------------------------------------------------------------------------------------------------------------------------------------------------------------------------------------------------------------------------------------------------------------------------------------------------------------------------------------------------------------------------------------------------------------------------------------------------------------------------------------------------------------------------------------------------------------------------------------------------------------------------------------------------------------------------------------------------------------------------------------------------------------------------------------------------------------|
| <b>Purpose</b>     | Specify or display systems of LMIs as MATLAB expressions                                                                                                                                                                                                                                                                                                                                                                                                                                                                                                                                                                                                                                                                                                                                                                                                                                                                                                                                                                                                                                                                                                                                                                                                                                                                                                                                                                                                                                                                                                                                                                                                                                                                                                                                                                                                                                                                                                                                                                                                                                                                                |
| <b>Syntax</b>      | <code>lmiedit</code>                                                                                                                                                                                                                                                                                                                                                                                                                                                                                                                                                                                                                                                                                                                                                                                                                                                                                                                                                                                                                                                                                                                                                                                                                                                                                                                                                                                                                                                                                                                                                                                                                                                                                                                                                                                                                                                                                                                                                                                                                                                                                                                    |
| <b>Description</b> | <p><code>lmiedit</code> is a graphical user interface for the symbolic specification of LMI problems. Typing <code>lmiedit</code> calls up a window with two editable text areas and various buttons. To specify an LMI system,</p> <ol style="list-style-type: none"> <li><b>1</b> Give it a name (top of the window).</li> <li><b>2</b> Declare each matrix variable (name and structure) in the upper half of the window. The structure is characterized by its type (S for symmetric block diagonal, R for unstructured, and G for other structures) and by an additional structure matrix similar to the second input argument of <code>lmivar</code>. Please use one line per matrix variable in the text editing areas.</li> <li><b>3</b> Specify the LMIs as MATLAB expressions in the lower half of the window. An LMI can stretch over several lines. However, do not specify more than one LMI per line.</li> </ol> <p>Once the LMI system is fully specified, you can perform the following operations by pressing the corresponding button:</p> <ul style="list-style-type: none"> <li>• Visualize the sequence of <code>lmivar/lmiterm</code> commands needed to describe this LMI system (view commands buttons)</li> <li>• Conversely, display the symbolic expression of the LMI system produced by a particular sequence of <code>lmivar/lmiterm</code> commands (click the describe... buttons)</li> <li>• Save the symbolic description of the LMI system as a MATLAB string (save button). This description can be reloaded later on by pressing the load button</li> <li>• Read a sequence of <code>lmivar/lmiterm</code> commands from a file (read button). The matrix expression of the LMI system specified by these commands is then displayed by clicking on describe the LMIs...</li> <li>• Write in a file the sequence of <code>lmivar/lmiterm</code> commands needed to specify a particular LMI system (write button)</li> <li>• Generate the internal representation of the LMI system by pressing create. The result is written in a MATLAB variable with the same name as the LMI system</li> </ul> |

# Imiedit

---

## Remark

Editable text areas have built-in scrolling capabilities. To activate the scroll mode, click in the text area, maintain the mouse button down, and move the mouse up or down. The scroll mode is only active when all visible lines have been used.

## See Also

|                      |                                                                                 |
|----------------------|---------------------------------------------------------------------------------|
| <code>lmivar</code>  | Specify the matrix variables in an LMI problem                                  |
| <code>lmiterm</code> | Specify the term content of LMIs                                                |
| <code>newlmi</code>  | Attach an identifying tag to LMIs                                               |
| <code>lmiinfo</code> | Interactively retrieve information about the variables and term content of LMIs |

**Purpose** Interactively retrieve information about the variables and term content of LMIs

**Syntax** `lmiinfo(lmisys)`

**Description** `lmiinfo` provides qualitative information about the system of LMIs `lmisys`. This includes the type and structure of the matrix variables, the number of diagonal blocks in the inner factors, and the term content of each block.

`lmiinfo` is an interactive facility where the user seeks specific pieces of information. General LMIs are displayed as

$$N' * L(x) * N < M' * R(x) * M$$

where  $N, M$  denote the outer factors and  $L, R$  the left and right inner factors. If the outer factors are missing, the LMI is simply written as

$$L(x) < R(x)$$

If its right-hand side is zero, it is displayed as

$$N' * L(x) * N < 0$$

Information on the block structure and term content of  $L(x)$  and  $R(x)$  is also available. The term content of a block is symbolically displayed as

$$C_1 + A_1 * X_2 * B_1 + B_1' * X_2 * A_1' + a_2 * X_1 + x_3 * Q_1$$

with the following conventions:

- $X_1, X_2, X_3$  denote the problem variables. Upper-case  $X$  indicates matrix variables while lower-case  $x$  indicates scalar variables. The labels 1,2,3 refer to the first, second, and third matrix variable in the order of declaration.
- $C_j$  refers to constant terms. Special cases are  $I$  and  $-I$  ( $I$  = identity matrix).
- $A_j, B_j$  denote the left and right coefficients of variable terms. Lower-case letters such as  $a_2$  indicate a scalar coefficient.
- $Q_j$  is used exclusively with scalar variables as in  $x_3 * Q_1$ .

The index  $j$  in  $A_j, B_j, C_j, Q_j$  is a dummy label. Hence  $C_1$  may appear in several blocks or several LMIs without implying any connection between the corresponding constant terms. Exceptions to this rule are the notations

$A_1^T X_2 A_1$  and  $A_1^T X_2 B_1 + B_1^T X_2 A_1$  which indicate symmetric terms and symmetric pairs in diagonal blocks.

## Example

Consider the LMI

$$0 \preceq \begin{pmatrix} -2X + A^T Y B + B^T Y^T A + I & X C \\ C^T X & -zI \end{pmatrix}$$

where the matrix variables are  $X$  of Type 1,  $Y$  of Type 2, and  $z$  scalar. If this LMI is described in `lmis`, information about  $X$  and the LMI block structure can be obtained as follows:

```
lmiinfo(lmis)
```

```
          LMI ORACLE  
-----
```

```
This is a system of 1 LMI with 3 variable matrices
```

```
Do you want information on  
(v) matrix variables (l) LMIs (q) quit
```

```
?> v
```

```
Which variable matrix (enter its index k between 1 and 3) ? 1  
X1 is a 2x2 symmetric block diagonal matrix  
its (1,1)-block is a full block of size 2
```

```
-----
```

```
This is a system of 1 LMI with 3 variable matrices  
Do you want information on  
(v) matrix variables (l) LMIs (q) quit
```

```
?> l
```

```
Which LMI (enter its number k between 1 and 1) ? 1
```

```
This LMI is of the form
```

$0 < R(x)$   
 where the inner factor(s) has 2 diagonal block(s)

Do you want info on the right inner factor ?

(w) whole factor (b) only one block  
 (o) other LMI (t) back to top level

?> w

Info about the right inner factor

block (1,1) :  $I + a1*X1 + A2*X2*B2 + B2'*X2'*A2'$

block (2,1) :  $A3*X1$

block (2,2) :  $x3*A4$

(w) whole factor (b) only one block  
 (o) other LMI (t) back to top level

-----

This is a system of 1 LMI with 3 variable matrices

Do you want information on  
 (v) matrix variables (l) LMIs (q) quit

?> q

It has been a pleasure serving you!

Note that the prompt symbol is ?> and that answers are either indices or letters. All blocks can be displayed at once with option (w), or you can prompt for specific blocks with option (b).

## Remark

lmiinfo does not provide access to the numerical value of LMI coefficients.

# Imiinfo

---

## See Also

|                      |                                                                                    |
|----------------------|------------------------------------------------------------------------------------|
| <code>decinfo</code> | Describe how the entries of a matrix variable $X$ relate to the decision variables |
| <code>lminbr</code>  | Return the number of LMIs in an LMI system                                         |
| <code>matnbr</code>  | Return the number of matrix variables in a system of LMIs                          |
| <code>decnbr</code>  | Give the total number of decision variables in a system of LMIs                    |



|                      |                                                                                                                                                                                                                                                      |                      |                                                                                 |                     |                                                           |
|----------------------|------------------------------------------------------------------------------------------------------------------------------------------------------------------------------------------------------------------------------------------------------|----------------------|---------------------------------------------------------------------------------|---------------------|-----------------------------------------------------------|
| <b>Purpose</b>       | Return the number of LMIs in an LMI system                                                                                                                                                                                                           |                      |                                                                                 |                     |                                                           |
| <b>Syntax</b>        | <code>k = lminbr(lmisys)</code>                                                                                                                                                                                                                      |                      |                                                                                 |                     |                                                           |
| <b>Description</b>   | <code>lminbr</code> returns the number <code>k</code> of linear matrix inequalities in the LMI problem described in <code>lmisys</code> .                                                                                                            |                      |                                                                                 |                     |                                                           |
| <b>See Also</b>      | <table><tr><td><code>lmiinfo</code></td><td>Interactively retrieve information about the variables and term content of LMIs</td></tr><tr><td><code>matnbr</code></td><td>Return the number of matrix variables in a system of LMIs</td></tr></table> | <code>lmiinfo</code> | Interactively retrieve information about the variables and term content of LMIs | <code>matnbr</code> | Return the number of matrix variables in a system of LMIs |
| <code>lmiinfo</code> | Interactively retrieve information about the variables and term content of LMIs                                                                                                                                                                      |                      |                                                                                 |                     |                                                           |
| <code>matnbr</code>  | Return the number of matrix variables in a system of LMIs                                                                                                                                                                                            |                      |                                                                                 |                     |                                                           |

# lmireg

---

**Purpose** Specify LMI regions for pole placement purposes

**Syntax**  
`region = lmireg`  
`region = lmireg(reg1, reg2, ...)`

**Description** `lmireg` is an interactive facility to specify the LMI regions involved in multi-objective  $H_\infty$  synthesis with pole placement constraints (see `msfsyn`). Recall that an LMI region is any convex subset  $D$  of the complex plane that can be characterized by an LMI in  $z$  and  $\bar{z}$ , i.e.,

$$D = \{z \in \mathbf{C} : L + Mz + M^T \bar{z} < 0\}$$

for some fixed real matrices  $M$  and  $L = L^T$ . This class of regions encompasses half planes, strips, conic sectors, disks, ellipses, and any intersection of the above.

Calling `lmireg` without argument starts an interactive query/answer session where you can specify the region of your choice. The matrix `region = [L, M]` is returned upon termination. This matrix description of the LMI region can be passed directly to `msfsyn` for synthesis purposes.

The function `lmireg` can also be used to intersect previously defined LMI regions `reg1, reg2, ...`. The output `region` is then the  $[L, M]$  description of the intersection of these regions.

**See Also** `msfsyn` Multi-model/multi-objective state-feedback synthesis

**Purpose** Specify the term content of LMIs

**Syntax** `lmiterm(termID,A,B,flag)`

**Description** `lmiterm` specifies the term content of an LMI one term at a time. Recall that *LMI term* refers to the elementary additive terms involved in the block-matrix expression of the LMI. Before using `lmiterm`, the LMI description must be initialized with `setlmi` and the matrix variables must be declared with `lmivar`. Each `lmiterm` command adds one extra term to the LMI system currently described.

LMI terms are one of the following entities:

- outer factors
- constant terms (fixed matrices)
- variable terms  $AXB$  or  $AX^TB$  where  $X$  is a matrix variable and  $A$  and  $B$  are given matrices called the term coefficients.

When describing an LMI with several blocks, remember to specify **only the terms in the blocks on or below the diagonal** (or equivalently, only the terms in blocks on or above the diagonal). For instance, specify the blocks (1,1), (2,1), and (2,2) in a two-block LMI.

In the calling of `lmiterm`, `termID` is a four-entry vector of integers specifying the term location and the matrix variable involved.

$$\text{termID} (1) = \begin{cases} +p \\ -p \end{cases}$$

where positive  $p$  is for terms on the *left-hand side* of the  $p$ -th LMI and negative  $p$  is for terms on the *right-hand side* of the  $p$ -th LMI.

Recall that, by convention, the left-hand side always refers to the smaller side of the LMI. The index  $p$  is relative to the order of declaration and corresponds to the identifier returned by `newlmi`.

$$\text{termID} (2:3) = \begin{cases} [0, 0] & \text{for outer factors} \\ [i, j] & \text{for terms in the } (i, j)\text{-th} \\ & \text{block of the left or right inner factor} \end{cases}$$

# lmiterm

$$\text{termID (4)} = \begin{cases} 0 & \text{for outer factors} \\ x & \text{for variable terms } AXB \\ -x & \text{for variable terms } AX^T B \end{cases}$$

where  $x$  is the identifier of the matrix variable  $X$  as returned by `lmiavar`.  
The arguments  $A$  and  $B$  contain the numerical data and are set according to:

| Type of Term                       | A                                           | B                                           |
|------------------------------------|---------------------------------------------|---------------------------------------------|
| outer factor $N$                   | matrix value of $N$                         | omit                                        |
| constant term $C$                  | matrix value of $C$                         | omit                                        |
| variable term<br>$AXB$ or $AX^T B$ | matrix value of $A$<br>(1 if $A$ is absent) | matrix value of $B$<br>(1 if $B$ is absent) |

Note that identity outer factors and zero constant terms need not be specified.  
The extra argument `flag` is optional and concerns only conjugated expressions of the form

$$(AXB) + (AXB)^T = AXB + B^T X^T A^T$$

in *diagonal blocks*. Setting `flag = 's'` allows you to specify such expressions with a single `lmiterm` command. For instance,

```
lmiterm([1 1 1 X],A,1,'s')
```

adds the symmetrized expression  $AX + X^T A^T$  to the (1,1) block of the first LMI and summarizes the two commands

```
lmiterm([1 1 1 X],A,1)
lmiterm([1 1 1 X],1,A')
```

Aside from being convenient, this shortcut also results in a more efficient representation of the LMI.

## Example

Consider the LMI

$$\begin{pmatrix} 2AX_2A^T - x_3E + DD^T & B^TX_1 \\ X_1^TB & -I \end{pmatrix} < M^T \begin{pmatrix} CX_1C^T + CX_1^TC^T & 0 \\ 0 & -fX_2 \end{pmatrix} M$$

where  $X_1, X_2$  are matrix variables of Types 2 and 1, respectively, and  $x_3$  is a scalar variable (Type 1).

After initializing the LMI description with `setlmi` and declaring the matrix variables with `lmivar`, the terms on the left-hand side of this LMI are specified by:

```
lmiterm([1 1 1 X2],2*A,A') % 2*A*X2*A'
lmiterm([1 1 1 x3],-1,E) % -x3*E
lmiterm([1 1 1 0],D*D') % D*D'
lmiterm([1 2 1 -X1],1,B) % X1'*B
lmiterm([1 2 2 0],-1) % -I
```

Here  $X_1, X_2, X_3$  should be the variable identifiers returned by `lmivar`.

Similarly, the term content of the right-hand side is specified by:

```
lmiterm([-1 0 0 0],M) % outer factor M
lmiterm([-1 1 1 X1],C,C','s') % C*X1*C'+C*X1'*C'
lmiterm([-1 2 2 X2],-f,1) % -f*X2
```

Note that  $CX_1C^T + CX_1^TC^T$  is specified by a single `lmiterm` command with the flag 's' to ensure proper symmetrization.

## See Also

|                      |                                                          |
|----------------------|----------------------------------------------------------|
| <code>setlmi</code>  | Initialize the description of an LMI system              |
| <code>lmivar</code>  | Specify the matrix variables in an LMI problem           |
| <code>getlmi</code>  | Get the internal description of an LMI system            |
| <code>lmiedit</code> | Specify or display systems of LMIs as MATLAB expressions |
| <code>newlmi</code>  | Attach an identifying tag to LMIs                        |

# lmivar

---

**Purpose** Specify the matrix variables in an LMI problem

**Syntax**  
 $X = \text{lmivar}(\text{type}, \text{struct})$   
 $[X, n, sX] = \text{lmivar}(\text{type}, \text{struct})$

**Description** `lmivar` defines a new matrix variable  $X$  in the LMI system currently described. The optional output  $X$  is an identifier that can be used for subsequent reference to this new variable.

The first argument `type` selects among available types of variables and the second argument `struct` gives further information on the structure of  $X$  depending on its type. Available variable types include:

**type=1:** Symmetric matrices with a block-diagonal structure. Each diagonal block is either full (arbitrary symmetric matrix), scalar (a multiple of the identity matrix), or identically zero.

If  $X$  has  $R$  diagonal blocks, `struct` is an  $R$ -by-2 matrix where

- `struct(r, 1)` is the size of the  $r$ -th block
- `struct(r, 2)` is the type of the  $r$ -th block (1 for full, 0 for scalar, -1 for zero block).

**type=2:** Full  $m$ -by- $n$  rectangular matrix. Set `struct = [m, n]` in this case.

**type=3:** Other structures. With Type 3, each entry of  $X$  is specified as zero or  $\pm x_n$  where  $x_n$  is the  $n$ -th decision variable.

Accordingly, `struct` is a matrix of the same dimensions as  $X$  such that

- `struct(i, j)=0` if  $X(i, j)$  is a hard zero
- `struct(i, j)=n` if  $X(i, j) = x_n$   
`struct(i, j)=-n` if  $X(i, j) = -x_n$

Sophisticated matrix variable structures can be defined with Type 3. To specify a variable  $X$  of Type 3, first identify how many *free independent entries* are involved in  $X$ . These constitute the set of decision variables associated with  $X$ . If the problem already involves  $n$  decision variables, label the new free variables as  $x_{n+1}, \dots, x_{n+p}$ . The structure of  $X$  is then defined in terms of  $x_{n+1}, \dots, x_{n+p}$  as indicated above. To help specify matrix variables of Type 3, `lmivar` optionally returns two extra outputs: (1) the total number  $n$  of scalar

decision variables used so far and (2) a matrix  $sX$  showing the entry-wise dependence of  $X$  on the decision variables  $x_1, \dots, x_n$ .

**Example 1**

Consider an LMI system with three matrix variables  $X_1, X_2, X_3$  such that

- $X_1$  is a  $3 \times 3$  symmetric matrix (unstructured),
- $X_2$  is a  $2 \times 4$  rectangular matrix (unstructured),
- $X_3 =$

$$\begin{pmatrix} \Delta & 0 & 0 \\ 0 & \delta_1 & 0 \\ 0 & 0 & \delta_2 I_2 \end{pmatrix}$$

where  $\Delta$  is an arbitrary  $5 \times 5$  symmetric matrix,  $\delta_1$  and  $\delta_2$  are scalars, and  $I_2$  denotes the identity matrix of size 2.

These three variables are defined by

```
setlmis([])
X1 = lmivar(1,[3 1]) % Type 1
X2 = lmivar(2,[2 4]) % Type 2 of dim. 2x4
X3 = lmivar(1,[5 1;1 0;2 0]) % Type 1
```

The last command defines  $X_3$  as a variable of Type 1 with one full block of size 5 and two scalar blocks of sizes 1 and 2, respectively.

**Example 2**

Combined with the extra outputs  $n$  and  $sX$  of `lmivar`, Type 3 allows you to specify fairly complex matrix variable structures. For instance, consider a matrix variable  $X$  with structure

$$X = \begin{pmatrix} X_1 & 0 \\ 0 & X_2 \end{pmatrix}$$

where  $X_1$  and  $X_2$  are 2-by-3 and 3-by-2 rectangular matrices, respectively. You can specify this structure as follows:

- 1 Define the rectangular variables  $X_1$  and  $X_2$  by

```
setlmis([])
[X1,n,sX1] = lmivar(2,[2 3])
```

```
[X2,n,sX2] = lmivar(2,[3 2])
```

The outputs sX1 and sX2 give the decision variable content of  $X_1$  and  $X_2$ :

sX1

```
sX1 =  
    1    2    3  
    4    5    6
```

sX2

```
sX2 =  
    7    8  
    9   10  
   11   12
```

For instance,  $sX2(1,1)=7$  means that the (1,1) entry of  $X_2$  is the seventh decision variable.

- 2 Use Type 3 to specify the matrix variable  $X$  and define its structure in terms of those of  $X_1$  and  $X_2$ :

```
[X,n,sX] = lmivar(3,[sX1,zeros(2);zeros(3),sX2])
```

The resulting variable  $X$  has the prescribed structure as confirmed by

sX

```
sX =  
    1    2    3    0    0  
    4    5    6    0    0  
    0    0    0    7    8  
    0    0    0    9   10  
    0    0    0   11  12
```

## See Also

|         |                                                          |
|---------|----------------------------------------------------------|
| setlmis | Initialize the description of an LMI system              |
| lmiterm | Specify the term content of LMIs                         |
| getlmis | Get the internal description of an LMI system            |
| lmiedit | Specify or display systems of LMIs as MATLAB expressions |
| skewdec | Form a skew-symmetric matrix                             |
| delmvar | Delete one of the matrix variables of an LMI problem     |



`setmvar`

Instantiate a matrix variable and evaluate all LMI terms involving this matrix variable

# frd/loglog

---

**Purpose** Log-log scale plot of frd objects.

**Syntax** `loglog(sys)`  
`loglog(sys,linetype)`

**Description** `loglog` is the same as `plot` except a logarithmic (base 10) scale is used for both the X- and Y-axis.

The argument list consists of (many) X-data, Y-data and line type. triples. The X-data and Y-data can be specified individually, as doubles, or jointly as an frd.

**Example** Generate three frequency response objects, `sys1g`, `sys2g` and `sys3g`. Plot the magnitude of these transfer functions versus frequency on an log-log plot.

```
omega = logspace(-2,2,40);  
sys1 = tf(0.9,[.1 1]);  
sys1g = frd(sys1,omega);  
sys2 = tf(0.9,[1 1]);  
sys2g = frd(sys2,omega);  
sys3 = tf(0.9,[10 1]);  
sys3g = frd(sys3,omega);  
loglog(abs(sys1g),abs(sys2g),'r+',sys3g.Freq,...
```

```
abs(sys3g.Resp(:)), '--');
```

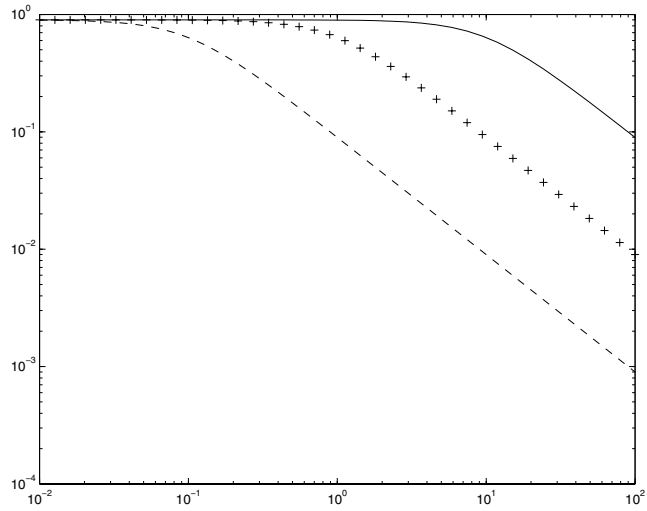

**See Also**

plot  
semilogx  
semilogy

Plots on linear axis  
Plots semi-log scale plot  
Plots semi-log scale plot

# loopmargin

---

**Purpose** Comprehensive analysis of feedback loops

**Syntax** `[sm,dm,mm] = loopmargin(L)`  
`[smi,dmi,mmi,smo,dmo,mmo,mmio] = loopmargin(P,C)`

**Description** `[sm,dm,mm] = loopmargin(L)` analyzes the multivariable feedback loop consisting of the loop transfer matrix  $L$  (size  $N$ -by- $N$ ) in negative feedback with an  $N$ -by- $N$  identity matrix.

`sm`, or single-loop margin, is an  $N$ -by-1 structure corresponding to loop-at-a-time gain and phase margins for each channel.

`dm` is an  $N$ -by-1 structure corresponding to loop-at-a-time disk gain and phase margins for each channel. The disk margin for the  $i$ -th feedback channel defines a circular region centered on the negative real axis at the average GainMargin (GM), e.g.  $(GM_{low}+GM_{high})/2$ , such that  $L(i,i)$  does not enter that region. Gain and phase disk margin bounds are derived from the radius of the circle, calculated based on the balanced sensitivity function (see Algorithm).

`mm`, or multi-loop disk margin, is a structure corresponding to simultaneous, independent, variations in the individual channels of loop transfer matrix  $L$ . `mm` calculates the largest region such that for all gain and phase variations, occurring independently in each channel, which lie inside the region the closed-loop system is stable. Note that `mm` is a single structure, independent of the number of channels, since variations in all channels are handled simultaneously. As in the case for disk margin, the guaranteed bounds are calculated based on a balanced sensitivity function.

If  $L$  is an `ufrd` or `uss` object, then the nominal value, `L.NominalValue`, of  $L$  is used in the loop analysis.

The `wcmargin` command can be used to analyze single-loop margins in the presence of the worst-case uncertainty. The disk margin and multi-loop disk margin calculations are performed in the frequency domain. If  $L$  is a `ss`/`tf`/`zpk`/`uss` object, the frequency range and number of points used to calculate `dm` and `mm` margins are chosen automatically (see `bode` command).

`[smi,dmi,mmi,smo,dmo,mmo,mmio] = loopmargin(p,c)` analyzes the multivariable feedback loop consisting of the controller,  $C$ , in negative feedback with the plant,  $P$ .  $C$  should only be the compensator in the feedback path, without reference channels, if it is a 2-*dof* architecture. That is, if the

closed-loop system has a 2-dof architecture the reference channel of the controller should be eliminated resulting in a 1-dof architecture as shown in the figure below.

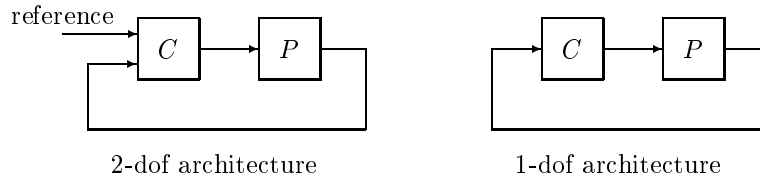

`smi`, `dmi` and `mmi` structures correspond to the loop-at-a-time gain and phase margins, disk margins and multi-loop channel margins at the plant input respectively. The structures `smo`, `dmo` and `mmo` have the same fields as described for `smi`, `dmi` and `mmi` though they correspond to the plant outputs. `mmio`, or multi-input/multi-output margins, is a structure corresponding to simultaneous, independent, variations in all the individual input and output channels of the feedback loops. `mmio` has the same fields as `mmi` and `mmo`.

The nominal values of `P` and `C` are used in the analysis if `P` and/or `C` are uncertain system or frequency response objects. If the closed-loop system is a `ss`/`tf`/`zpk`/`uss`, the frequency range and number of points used to calculate `sm`, `dm` and `mm` margins are chosen automatically.

### Basic syntax

`[ sm, dm, mm ] = loopmargin(L)` `sm` is calculated using the `allmargin` command and has the same fields as `allmargin`. The `sm` is a structure with the following fields:

| Field                    | Description                                                                  |
|--------------------------|------------------------------------------------------------------------------|
| <code>GMFrequency</code> | All -180 deg crossover frequencies (in rad/s)                                |
| <code>GainMargin</code>  | Corresponding gain margins (g.m. = $1/G$ where $G$ is the gain at crossover) |
| <code>PhaseMargin</code> | Corresponding phase margins (in degrees)                                     |
| <code>PMFrequency</code> | All 0 dB crossover frequencies (in rad/s)                                    |

# loopmargin

| Field       | Description                                                                                                        |
|-------------|--------------------------------------------------------------------------------------------------------------------|
| DelayMargin | Delay margins (in seconds for continuous-time systems, and multiples of the sample time for discrete-time systems) |
| Stable      | 1 if nominal closed loop is stable, 0 otherwise. If L is a frd or ufrd object, the Stable flag is set to NaN.      |

dm, or Disk Margin, is a structure with the following fields

| Field       | Description                                                                                                                           |
|-------------|---------------------------------------------------------------------------------------------------------------------------------------|
| GainMargin  | Smallest gain variation (GM) such that a disk centered at the point $-(GM(1) + GM(2))/2$ would just touch the loop transfer function. |
| PhaseMargin | Smallest phase variation, in degrees, corresponding to the disk described in the GainMargin field (degrees).                          |
| Frequency   | Associated with GainMargin/PhaseMargin fields (rad/s).                                                                                |

mm is a structure with the following fields:

| Field       | Description                                                                                                |
|-------------|------------------------------------------------------------------------------------------------------------|
| GainMargin  | Guaranteed bound on simultaneous, independent, gain variations allowed in all plant channel(s).            |
| PhaseMargin | Guaranteed bound on simultaneous, independent, phase variations allowed in all plant channel(s) (degrees). |
| Frequency   | Associated with GainMargin/PhaseMargin fields (rad/s).                                                     |

## Example

### MIMO Loop-at-a-Time Margins

This example is designed to illustrate that loop-at-a-time margins (gain, phase, and/or distance to  $-1$ ) can be inaccurate measures of multivariable robustness margins. We will see that margins of the individual loops may be very sensitive to small perturbations within other loops.

The nominal closed-loop system considered here is shown as follows

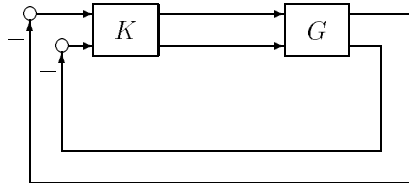

$G$  and  $K$  are  $2 \times 2$  multi-input/multi-output (MIMO) systems, defined as

$$G: = \frac{1}{s^2 + \alpha^2} \begin{bmatrix} s - \alpha^2 & \alpha(s + 1) \\ -\alpha(s + 1) & s - \alpha^2 \end{bmatrix}, K = I_2$$

Set  $\alpha := 10$ , construct  $G$  in state-space form and compute its frequency response.

```
a = [0 10; -10 0];
b = eye(2);
c = [1 8; -10 1];
d = zeros(2,2);
G = ss(a,b,c,d);
K = [1 -2; 0 1];
[smi,dmi,mmi,smo,dmo,mmo,mmio]=loopmargin(G,K);
```

First consider the margins at the input to the plant. The first input channel has infinite gain margin and 90 degrees of phase margin based on the results from the `allmargin` command, `smi(1)`. The disk margin analysis, `dmi`, of the first channel provide similar results.

```
smi(1)
ans =
    GMFrequency: [1x0 double]
    GainMargin: [1x0 double]
    PMFrequency: 21
```

# loopmargin

---

```
PhaseMargin: 90
DMFrequency: 21
DelayMargin: 0.0748
Stable: 1
dmi(1)
ans =
GainMargin: [0 Inf]
PhaseMargin: [-90 90]
Frequency: 1.1168
```

The second input channel has a gain margin of 2.105 and infinite phase margin based on the single-loop analysis, `smi(2)`. The disk margin analysis, `dmi(2)`, which allows for simultaneous gain and phase variations a loop-at-a-time results in maximum gain margin variations of 0.475 and 2.105 and phase margin variations of +/- 39.18 degs.

```
smi(2)
ans =
GMFrequency: 0
GainMargin: 2.1053
PMFrequency: [1x0 double]
PhaseMargin: [1x0 double]
DMFrequency: [1x0 double]
DelayMargin: [1x0 double]
Stable: 1
dmi(2)
ans =
GainMargin: [0.4749 2.1056]
PhaseMargin: [-39.1912 39.1912]
Frequency: 0.0200
```

The multiple margin analysis of the plant inputs corresponds to allowing simultaneous, independent gain and phase margin variations in each channel. Allowing independent variation of the input channels further reduces the tolerance of the closed-loop system to variations at the input to the plant. The multivariable margin analysis, `mmi`, leads to a maximum allowable gain margin variation of 0.728 and 1.373 and phase margin variations of +/- 17.87 degs. Hence even though the first channel had infinite gain margin and 90 degrees of phase margin, allowing variation in both input channels leads to a factor of two reduction in the gain and phase margin.



```

mmi
mmi =
    GainMargin: [0.7283 1.3730]
    PhaseMargin: [-17.8659 17.8659]
    Frequency: 9.5238e-004

```

The guaranteed region of phase and gain variations for the closed-loop system can be illustrated graphically. The disk margin analysis, `dmi(2)`, indicates the closed-loop system will remain stable for simultaneous gain variations of 0.475 and 2.105 ( $\pm 6.465$  dB) and phase margin variations of  $\pm 39.18$  degs in the second input channel. This is denoted by the region associated with the large ellipse in the following figure. The multivariable margin analysis at the input to the plant, `mmi`, indicates that the closed-loop system will be stable for independent, simultaneous, gain margin variation up to 0.728 and 1.373 ( $\pm 2.753$  dB) and phase margin variations up to  $\pm 17.87$  degs (the dark ellipse region) in both input channels.

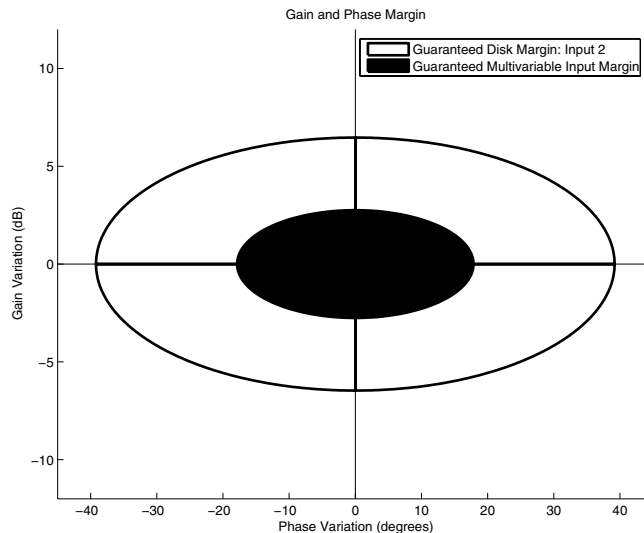

The output channels have single loop margins of infinite gain and 90 degs phase variation. The output multivariable margin analysis, `mmo`, leads to a maximum allowable gain margin variation of 0.607 and 1.649 and phase

# loopmargin

---

margin variations of +/- 27.53 degs. Hence even though both output channels had infinite gain margin and 90 degrees of phase margin, simultaneous variations in both channels significantly reduces the margins at the plant outputs.

```
mimo
mimo =
    GainMargin: [0.6065 1.6489]
    PhaseMargin: [-27.5293 27.5293]
    Frequency: 0.2287
```

If all the input and output channels are allowed to vary independently, `mimo`, the gain margin variation of 0.827 and 1.210 and phase margin variations of +/- 10.84 degs.

```
mimo
mimo =
    GainMargin: [0.8267 1.2097]
    PhaseMargin: [-10.8402 10.8402]
    Frequency: 0.2287
```

## Algorithm

Two well known loop robustness measures are based on the sensitivity function,  $S=(I-L)^{-1}$  and the complementary sensitivity function,  $T=L(I-L)^{-1}$  where  $L$  is the loop gain matrix associated with the input or output loops broken simultaneously. In the following figure,  $S$  is the transfer matrix from summing junction input  $u$  to summing junction output  $e$ .  $T$  is the transfer matrix from  $u$  to  $y$ . If signals  $e$  and  $y$  are summed, the transfer matrix from  $u$  to  $e+y$  is given by  $(I+L)\cdot(I-L)^{-1}$ , the balanced sensitivity function. It can be shown (Dailey 1991, Blight, Daily and Gangass 1994) that each broken-loop gain may be perturbed by the complex gain  $(1+\Delta)(1-\Delta)$  where  $|\Delta| < 1/\mu(S+T)$  or  $|\Delta| < 1/\sigma_{max}(S+T)$  at each frequency without causing instability at that frequency. The peak value of  $\mu(S+T)$  or  $\sigma_{max}(S+T)$  gives a robustness guarantee

for all frequencies and for  $\mu(S+T)$ , the guarantee is non-conservative (Blight, Daily and Gangass 1994).

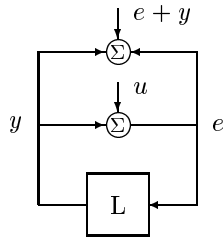

$$\begin{aligned}
 e &= (I - L)^{-1}u &= Su \\
 y &= L(I - L)^{-1}u &= Tu \\
 e + y &= (I + L) \cdot (I - L)^{-1}u &= (S + T)u
 \end{aligned}$$

# loopmargin

This figure shows a comparison of a disk margin analysis with the classical notations of gain and phase margins.

Disk gain margin (DGM) and disk phase margin (DPM) in the Nyquist plot

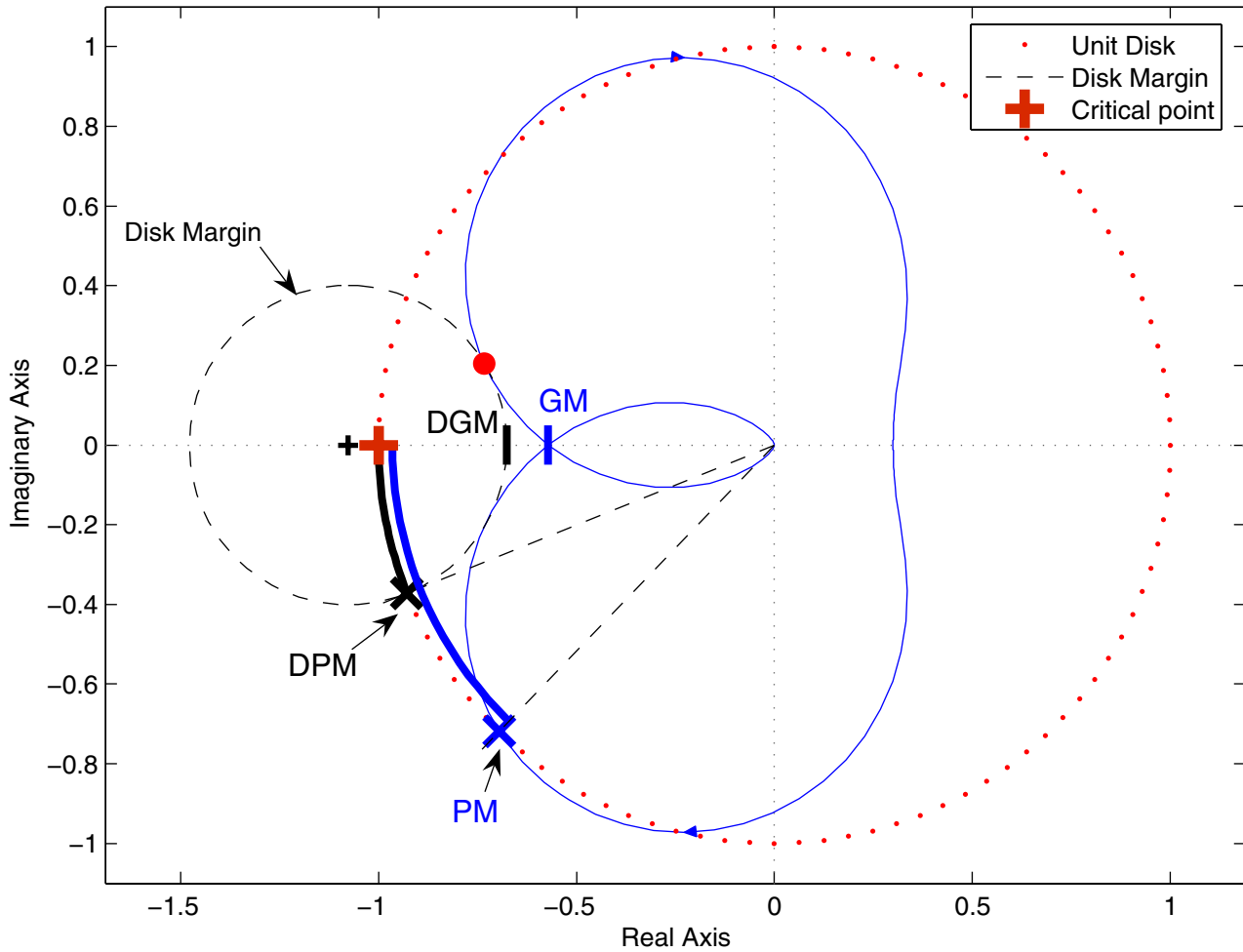

The Nyquist plot is of the loop transfer function  $L(s)$

$$L(s) = \frac{\frac{s}{30} + 1}{(s + 1)(s^2 + 1.6s + 16)}$$

- The Nyquist plot of  $L$  corresponds to the blue line
- The unit disk corresponds to the dotted red line
- GM and PM indicate the location of the classical gain and phase margins for the system  $L$ .
- DGM and DPM correspond to the disk gain and phase margins. The disk margins provide a lower bound on classical gain and phase margins.
- The disk margin circle corresponds to the dashed black line. The disk margin corresponds to the largest disk centered at  $(\text{GMD} + 1/\text{GMD})/2$  that just touches the loop transfer function  $L$ . This location is indicated by the red dot.

The disk margin and multiple channel margins calculation involve the balanced sensitivity function  $S+T$ . For a given peak value of  $\mu(S+T)$ , any simultaneous phase and gain variations applied to each loop independently will not destabilize the system if the perturbations remain inside the corresponding circle or disk. This corresponds to the disk margin calculation to find  $\text{dmi}$  and  $\text{dmo}$ .

Similarly, the multiple channel margins calculation involves the balanced sensitivity function  $S+T$ . Instead of calculating  $\mu(S+T)$  a single loop at a time, all the channels are included in the analysis. A  $\mu$ -analysis problem is formulated with each channel perturbed by an independent, complex perturbation. The peak  $\mu(S+T)$  value guarantees that any simultaneous, independent phase and gain variations applied to each loop simultaneously will not destabilize the system if they remain inside the corresponding circle or disk of size  $\mu(S+T)$ .

## See Also

|                         |                                                             |
|-------------------------|-------------------------------------------------------------|
| <code>allmargin</code>  | Finds all stability margins and crossover frequencies       |
| <code>bode</code>       | Plots Bode frequency response of LTI models                 |
| <code>loopsens</code>   | Calculates sensitivity functions of feedback loop           |
| <code>mussv</code>      | Calculate bounds on the Structured Singular Value ( $\mu$ ) |
| <code>robuststab</code> | Calculate stability margins of uncertain systems            |
| <code>wcgain</code>     | Calculates worst-case gain of a system                      |
| <code>wcsens</code>     | Calculate worst-case sensitivities for feedback loop        |

# loopmargin

---

wcmargin

Calculate worst-case margins for feedback loop

## Reference

Barrett, M.F. (1980), Conservatism with robustness tests for linear feedback control systems, *Ph.D. Thesis*, Control Science and Dynamical Systems, University of Minnesota.

Blight, J.D., Dailey, R.L. and Gangsass, D. (1994), "Practical control law design for aircraft using multivariable techniques," *International Journal of Control*, Vol. 59, No. 1, 93-137.

Bates, D. and I. Postlethwaite (2002), Robust Multivariable Control of Aerospace Systems, *Delft University Press*, Delft, The Netherlands, ISBN: 90-407-2317-6.

**Purpose** Sensitivity functions of plant-controller feedback loop

**Syntax** `loops = loopsens(P,C)`

**Description** `loops = loopsens(P,C)` creates a Struct, `loops`, whose fields contain the multivariable sensitivity, complementary and open-loop transfer functions. The closed-loop system consists of the controller, `C`, in negative feedback with the plant, `P`. `C` should only be the compensator in the feedback path, not any reference channels, if it is a *2-dof* controller as seen in the figure below. The plant and compensator, `P` and `C`, can be constant matrices, `double`, `1ti` objects, `frd/ss/tf/zpk`, or uncertain objects, `umat/ufrd/uss`.

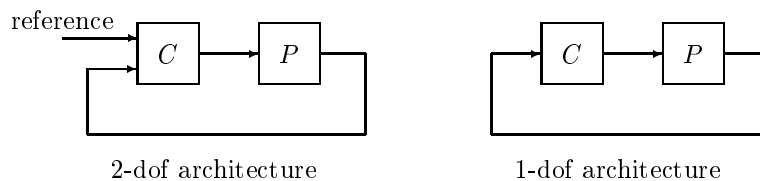

The `loops` structure contains the following fields:

| Field  | Description                                                                             |
|--------|-----------------------------------------------------------------------------------------|
| Poles  | Closed-loop poles. NaN for <code>frd/ufrd</code> objects.                               |
| Stable | 1 if nominal closed loop is stable, 0 otherwise. NaN for <code>frd/ufrd</code> objects. |
| Si     | Input-to-plant sensitivity function                                                     |
| Ti     | Input-to-plant complementary sensitivity function                                       |
| Li     | Input-to-plant loop transfer function                                                   |
| So     | Output-to-plant sensitivity function                                                    |
| To     | Output-to-plant complementary sensitivity function                                      |
| Lo     | Output-to-plant loop transfer function                                                  |
| PSi    | Plant times input-to-plant sensitivity function                                         |
| CSO    | Compensator times output-to-plant sensitivity function                                  |

The multivariable closed-loop interconnection structure, shown below, defines the input/output sensitivity, complementary sensitivity and loop transfer functions.

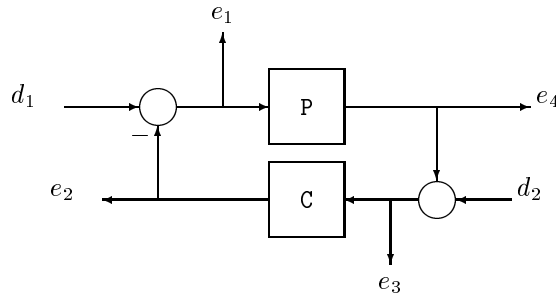

| Description                                                  | Equation        |
|--------------------------------------------------------------|-----------------|
| Input Sensitivity ( $TF_{e1 \leftarrow d1}$ )                | $(I+CP)^{-1}$   |
| Input Complementary Sensitivity ( $TF_{e2 \leftarrow d1}$ )  | $CP(I+CP)^{-1}$ |
| Output Sensitivity ( $TF_{e3 \leftarrow d2}$ )               | $(I+PC)^{-1}$   |
| Output Complementary Sensitivity ( $TF_{e4 \leftarrow d2}$ ) | $PC(I+PC)^{-1}$ |
| Input Loop Transfer Function                                 | $CP$            |
| Output Loop Transfer Function                                | $PC$            |

## Example

Consider a three-input and four-output plant with three integrators. One of the integrators, `uncint`, is uncertain. A four input, three output constant gain controller, `c`, is used to stabilize the closed-loop system. The gain of the controller (1,4) entry is uncertain, ranging between 0.02 and 1.5. You can use the `loopsens` command to construct the closed-loop system sensitivity, complementary sensitivity and loop transfer functions.

```
int = tf(1,[1 0]);
addunc = ultidyn('addunc',[1 1],'Bound',0.2);
uncint = int + addunc;
int3 = blkdiag(int,uncint,int);
p = [1 .2 .5;-.5 0 1;1 0 0;0 1 0]*int3;
```



```

gain = ureal('gain',0.9, 'Range',[-3 1.5]);
c = [.02 .3 0 0;1 -.3 .32 gain; 0 1 -.2 .1];
loops = loopsens(p,c)
loops =
    Poles: [3x1 double]
    Stable: 1
         Si: [3x3 uss]
         Ti: [3x3 uss]
         Li: [3x3 uss]
         So: [4x4 uss]
         To: [4x4 uss]
         Lo: [4x4 uss]
         PSi: [4x3 uss]
         CSo: [3x4 uss]

```

Note that the input sensitivity, complementary sensitivity and loop transfer functions have three inputs and three outputs, whereas the output sensitivity, complementary sensitivity and loop transfer functions have four inputs and four outputs. For the nominal plant model, i.e. the additive uncertainty addunc set to zero, the closed-loop system is stable only for positive values of the gain parameter.

```

gainval = reshape([-0.22 -0.215 -0.20 1.5],[1 1 4]);
nomSi = usubs(loops.Si,'gain',gainval);
pole(nomSi.NominalValue)
ans(:,:,1) =
    -0.8537
     0.0018 + 0.2164i
     0.0018 - 0.2164i
ans(:,:,2) =
    -0.8541
    -0.0004 + 0.2176i
    -0.0004 - 0.2176i
ans(:,:,3) =
    -0.8556
    -0.0072 + 0.2207i
    -0.0072 - 0.2207i
ans(:,:,4) =
    -0.1663
    -0.6505

```

# loopsens

---

-1.7533

## See Also

loopmargin  
robuststab  
wcsens  
wcmargin

Performs a comprehensive analysis of feedback loop  
Calculate stability margins of uncertain systems  
Calculate worst-case sensitivities for feedback loop  
Calculate worst-case margins for feedback loop

**Purpose** Compute a controller for plant  $G$  to optimally match target loop shape  $G_d$

**Syntax**  $[K, CL, GAM, INFO] = \text{loopsyn}(G, G_d)$   
 $[K, CL, GAM, INFO] = \text{loopsyn}(G, G_d, \text{RANGE})$

**Description**  $\text{loopsyn}$  is an  $H_\infty$  optimal method for loopshaping control synthesis. It computes a stabilizing  $H_\infty$  controller  $K$  for plant  $G$  to shape the sigma plot of the loop transfer function  $GK$  to have desired loop shape  $G_d$  with accuracy  $\gamma = \text{GAM}$  in the sense that if  $\omega_0$  is the 0db crossover frequency of the sigma plot of  $G_d(j\omega)$ , then, roughly,

$$\underline{\sigma}(G(j\omega)K(j\omega)) \geq \frac{1}{\gamma} \bar{\sigma}(G_d(j\omega)) \quad \text{for all } \omega < \omega_0 \quad (10-16)$$

$$\bar{\sigma}(G(j\omega)K(j\omega)) \leq \frac{1}{\gamma} \underline{\sigma}(G_d(j\omega)) \quad \text{for all } \omega > \omega_0 \quad (10-17)$$

The STRUCT array INFO returns additional design information, including a MIMO stable min-phase shaping pre-filter  $W$ , the shaped plant  $G_s = GW$ , the controller for the shaped plant  $K_s = WK$ , as well as the frequency range  $\{\omega_{\min}, \omega_{\max}\}$  over which the loop shaping is achieved..)

| Input arguments:  |                                                                                                                                                                                              |
|-------------------|----------------------------------------------------------------------------------------------------------------------------------------------------------------------------------------------|
| G                 | LTI Plant                                                                                                                                                                                    |
| Gd                | Desired loop-shape (LTI Model)                                                                                                                                                               |
| RANGE             | (optional, default {0, Inf}) Desired frequency range for loop-shaping, a 1-by-2 cell array $\{\omega_{\min}, \omega_{\max}\}$ ; $\omega_{\max}$ should be at least ten times $\omega_{\min}$ |
| Output arguments: |                                                                                                                                                                                              |
| K                 | LTI controller                                                                                                                                                                               |
| CL= G*K/(I+GK)    | LTI closed-loop system                                                                                                                                                                       |

|            |                                                                                                                                                                                                                                                              |
|------------|--------------------------------------------------------------------------------------------------------------------------------------------------------------------------------------------------------------------------------------------------------------|
| GAM        | loop-shaping accuracy ( $GAM \geq 1$ , with $GAM=1$ being perfect fit)                                                                                                                                                                                       |
| INFO       | additional output information                                                                                                                                                                                                                                |
| INFO.W     | LTI pre-filter $W$ satisfying $\sigma(G_d)=\sigma(GW)$ for all $\omega$ ; $W$ is always minimum-phase                                                                                                                                                        |
| INFO.Gs    | LTI shaped plant: $G_s = GW$                                                                                                                                                                                                                                 |
| INFO.Ks    | LTI controller for the shaped plant: $K_s=WK$                                                                                                                                                                                                                |
| INFO.range | $\{\omega_{\min}, \omega_{\max}\}$ cell-array containing the approximate frequency range over which loop-shaping could be accurately achieved to with accuracy $G$ . The output <code>INFO.range</code> is either the same as or a subset of the input range |

## Algorithm

Using the GCD formula of Le and Safonov [1], `loopsyn` first computes a stable-minimum-phase loop-shaping, squaring-down prefilter  $W$  such that the shaped plant  $G_s = GW$  is square, and the desired shape  $G_d$  is achieved with good accuracy in the frequency range  $\{\omega_{\min}, \omega_{\max}\}$  by the shaped plant; i.e.,

$$\sigma(G_d) \approx \sigma(G_s) \quad \text{for all } \omega \in \{\omega_{\min}, \omega_{\max}\}.$$

Then, `loopsyn` uses the Glover-McFarlane [2] normalized-coprime-factor control synthesis theory to compute an optimal “loop-shaping” controller for the shaped plant via  $K_s = \text{ncfsyn}(G_s)$ , and returns  $K = W * K_s$ .

If the plant  $G$  is a continuous time LTI and

- 1  $G$  has a full-rank D-matrix, and
- 2 no finite zeros on the  $j\omega$ -axis, and
- 3  $\{\omega_{\min}, \omega_{\max}\} = [0, \infty]$ ,

then  $GW$  theoretically achieves a perfect accuracy fit  $\sigma(G_d) = \sigma(GW)$  for all frequency  $\omega$ . Otherwise, `loopsyn` uses a bilinear pole-shifting bilinear transform [3] of the form

$$G_{\text{shifted}} = \text{bilin}(G, -1, 'S\_Tust', [\omega_{\min}, \omega_{\max}]),$$

which results in a perfect fit for transformed  $G_{\text{shifted}}$  and an approximate fit over the smaller frequency range  $[\omega_{\text{min}}, \omega_{\text{max}}]$  for the original unshifted  $G$  provided that  $\omega_{\text{max}} \gg \omega_{\text{min}}$ . For best results, you should choose  $\omega_{\text{max}}$  to be at least 100 times greater than  $\omega_{\text{min}}$ . In some cases, the computation of the optimal  $W$  for  $G_{\text{shifted}}$  may be singular or ill-conditioned for the range  $[\omega_{\text{min}}, \omega_{\text{max}}]$ , as when  $G_{\text{shifted}}$  has undamped zeros or, in the continuous-time case only,  $G_{\text{shifted}}$  has a  $D$ -matrix that is rank-deficient); in such cases, loopsyn automatically reduces the frequency range further, and returns the reduced range  $[\omega_{\text{min}}, \omega_{\text{max}}]$  as a cell array in the output `INFO.range={ $\omega_{\text{min}}, \omega_{\text{max}}$ }`

### Example

The following code generates the optimal loopsyn loopshaping control for the case of a 5-state, 4-output, 5-input plant with a full-rank non-minimum phase zero at  $s=+10$ . The result is shown in Figure 10-11.

```
rand('seed',0);randn('seed',0);
s=tf('s'); w0=5; Gd=5/s;           % desired bandwidth w0=5
G=((s-10)/(s+100))*rss(3,4,5);     % 4-by-5 non-min-phase plant
[K,CL,GAM,INFO]=loopsyn(G,Gd);
sigma(G*K,'r',Gd*GAM,'k-.',Gd/GAM,'k-.',{.1,100}) % plot result
```

This figure shows that the LOOPSYN controller  $K$  optimally fits

$$\sigma(G*K) = \sigma(Gd) - \text{GAM} \text{ dB}$$

In the above example,  $\text{GAM} = 2.0423 = 6.2026 \text{ dB}$ .

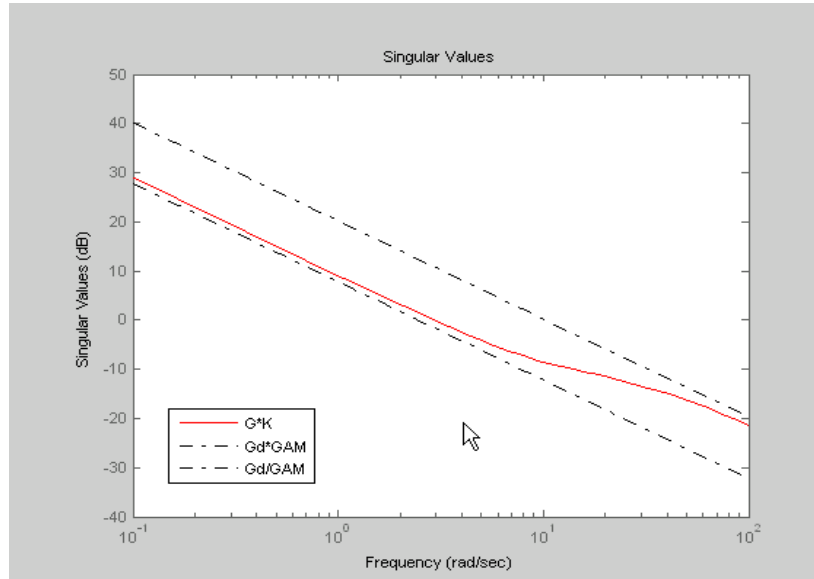

**Figure 10-11: LOOPSYN controller**

The loopsyn controller  $K$  optimally fits  $\sigma(G*K)$ . As shown in Figure 10-11, it is sandwiched between  $\sigma(G_d/GAM)$  and  $\sigma(G_d*GAM)$  in accordance with the inequalities in Equation 10-16 and Equation 10-17. In this example,  $GAM = 2.0423 = 6.2026$  db.

## Limitations

The plant  $G$  must be stabilizable and detectable, must have at least as many outputs and inputs, and must be full rank; i.e.,

- $\text{size}(G,2) \geq \text{size}(G,1)$
- $\text{rank}(\text{freqresp}(G,w)) = \text{size}(G,1)$  for some frequency  $w$ .

The order of the controller  $K$  can be large. Generically, when  $G_d$  is given as a SISO LTI, then the order  $N_K$  of the controller  $K$  satisfies

$$\begin{aligned} N_K &= N_{G_s} + N_W \\ &= N_y N_{G_d} + N_{RHP} + N_W \\ &= N_y N_{G_d} + N_{RHP} + N_G \end{aligned}$$

where

- $N_y$  denotes the number of outputs of the plant  $G$ ,
- $N_{RHP}$  denotes the total number of non-stable poles and non-minimum-phase zeros of the plant  $G$ , including those on the stability boundary and at infinity, and
- $N_G, N_{G_s}, N_{G_d}$  and  $N_W$  denote the respective orders of  $G, G_s, G_d$  and  $W$ .

Model reduction can help reduce the order of  $K$  — see `reduce` and `ncfmr`.

## References

- [1] Le, V. X., and M. G. Safonov. Rational matrix GCD's and the design of squaring-down compensators—a state space theory. *IEEE Trans. Autom. Control*, AC-36(3):384–392, March 1992.
- [2] Glover, K., and D. McFarlane. Robust stabilization of normalized coprime factor plant descriptions with  $H_\infty$ -bounded uncertainty. *IEEE Trans. Autom. Control*, AC-34(8):821–830, August 1992.
- [3] Chiang, R. Y., and M. G. Safonov.  $H_\infty$  synthesis using a bilinear pole-shifting transform. *AIAA J. Guidance, Control and Dynamics*, 15(5):1111–1115, September–October 1992.

## See Also

|                           |                                                      |
|---------------------------|------------------------------------------------------|
| <code>loopsyn_demo</code> | A demo of this function                              |
| <code>mixsyn</code>       | $H_\infty$ mixed-sensitivity controller synthesis    |
| <code>ncfsyn</code>       | $H_\infty$ - normalized coprime controller synthesis |

## Algorithm

Using a real eigen structure decomposition `reig` and ordering the eigenvectors in ascending order according to their eigenvalue magnitudes, we can form a similarity transformation out of these ordered real eigenvectors such that the resulting systems  $G_1$  and/or  $G_2$  are in block diagonal modal form.

**Note** This routine is extremely useful when model has  $j\omega$ -axis singularities, e.g., rigid body dynamics. If we apply the Hankel based model reduction routines directly such as `hankelmr`, `balancmr`, `bstmr`, or `schurmr` to the original model, the reduction routines can failed due to unsolvable grammians. However, if we apply `modreal` to the model first, isolate the rigid body dynamics part from the rest, apply the Hankel based model routines to

the non-rigid part, then add back the rigid dynamics, we can do a very successful model reduction task this way.

---

## Example

Given a continuous stable or unstable system,  $G$ , the following commands can get a set of modal form realizations depending on the split index -- cut:

```
randn('state',1234); rand('state',5678);
G = rss(50,2,2);
[G1,G2] = modreal(G,2); % cut = 2 for two rigid body modes
G2.d = G1.d; G1.d = zeros(2,2); % assign the DC gain to G2
sigma(G1,G2)
```

## See Also

|          |                                                    |
|----------|----------------------------------------------------|
| reduce   | Top level model reduction routines                 |
| balancmr | Balanced truncation via square-root method         |
| schurmr  | Balanced truncation via Schur method               |
| bstmr    | Balanced stochastic truncation via Schur method    |
| ncfmr    | Balanced truncation for normalized coprime factors |
| hankelmr | Hankel minimum degree approximation                |
| hankelsv | Hankel singular value                              |



**Purpose** LQG loop transfer-function recovery (LTR) control synthesis

**Syntax**

```
[K,SVL,W1] = ltrysyn(G,F,XI,THETA,RHO)
[K,SVL,W1] = ltrysyn(G,F,XI,THETA,RHO,W)
[K,SVL,W1] = ltrysyn(G,F,XI,THETA,RHO,OPT)
[K,SVL,W1] = ltrysyn(G,F,XI,THETA,RHO,W,OPT)
```

**Description** [K,SVL,W1] = ltrysyn(G,F,XI,TH,RHO) computes a reconstructed-state output-feedback controller K for LTI plant G so that K\*G asymptotically ‘recovers’ plant-input full-state feedback loop transfer function  $L(s) = F(Is-A)^{-1}B+D$ ; that is, at any frequency  $\omega > 0$ ,  $\max(\sigma(K*G-L, \omega)) \rightarrow 0$  as  $\rho \rightarrow \infty$ , where  $L = ss(A,B,F,D)$  is the LTI full-state feedback loop transfer function.

[K,SVL,W1] = ltrysyn(G,F1,Q,R,RHO,'OUTPUT') computes the solution to the ‘dual’ problem of filter loop recovery for LTI plant G where F is a Kalman filter gain matrix. In this case, the recovery is at the plant output, and  $\max(\sigma(G*K-L, \omega)) \rightarrow 0$  as  $\rho \rightarrow \infty$ , where L1 denotes the LTI filter loop feedback loop transfer function  $L1 = ss(A,F,C,D)$ .

Only the LTI controller K for the final value RHO(end) is returned.

| Inputs |                                                                                                                        |
|--------|------------------------------------------------------------------------------------------------------------------------|
| G      | LTI plant                                                                                                              |
| F      | LQ full-state-feedback gain matrix                                                                                     |
| XI     | plant noise intensity,<br>or, if OPT='OUTPUT' state-cost matrix XI=Q,                                                  |
| THETA  | sensor noise intensity<br>or, if OPT='OUTPUT' control-cost matrix THETA=R,                                             |
| RHO    | vector containing a set of recovery gains                                                                              |
| W      | (optional) vector of frequencies (to be used for plots); if input W is not supplied, then a reasonable default is used |

| Outputs |                                                                                                                                     |
|---------|-------------------------------------------------------------------------------------------------------------------------------------|
| K       | $K(s)$ — LTI LTR (loop-transfer-recovery) output-feedback, for the last element of RHO (i.e., RHO(end))                             |
| SVL     | sigma plot data for the ‘recovered’ loop transfer function if G is MIMO or, for SISO G only, Nyquist loci SVL = [re(1:nr) im(1:nr)] |
| W1      | frequencies for SVL plots, same as W when present                                                                                   |

## Algorithm

For each value in the vector RHO,  $[K, SVL, W1] = \text{ltrsyn}(G, F, XI, THETA, RHO)$  computes the full-state-feedback (default OPT='INPUT') LTR controller

$$K(s) = [K_c(Is - A + BK_c + K_f C - K_f D K_c)^{-1} K_f]$$

where  $K_c = F$  and  $K_f = \text{lqr}(A', C', XI + RHO(i) * B * B', THETA)$ . The ‘fictitious noise’ term  $RHO(i) * B * B'$  results in loop-transfer recovery as  $RHO(i) \rightarrow \infty$ . The

Kalman filter gain is  $K_f = \Sigma C^T \Theta^{-1}$  where  $\Sigma$  satisfies the Kalman filter Riccati equation  $0 = \Sigma A^T + A \Sigma - \Sigma C^T \Theta^{-1} C \Sigma + \Xi + \rho B B^T$ . See [1] for further details.

Similarly for the ‘dual’ problem of filter loop recovery case,  $[K, SVL, W1] = \text{ltrsyn}(G, F, Q, R, RHO, 'OUTPUT')$  computes a filter loop recovery controller of

the same form, but with  $K_f=F$  is being the input filter gain matrix and the control gain matrix  $K_c$  computed as  $K_c=lqr(A,B,Q+RHO(i)*C'*C,R)$ .

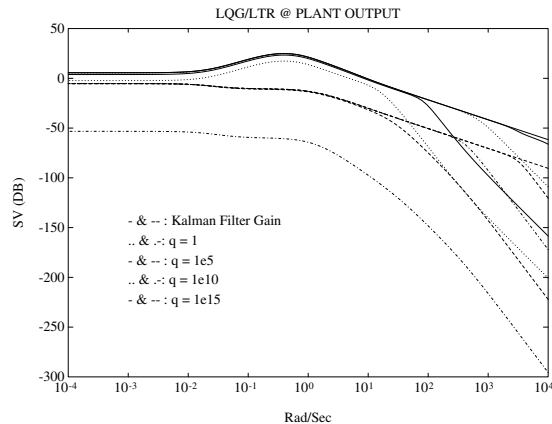

**Figure 10-12: Example of LQG/LTR at Plant Output.**

### Example

```
s=tf('s');G=ss(1e4/((s+1)*(s+10)*(s+100)));[A,B,C,D]=ssdata(G);
F=lqr(A,B,C'*C,eye(size(B,2)));
L=ss(A,B,F,0*F*B);
XI=100*C'*C; THETA=eye(size(C,1));
RHO=[1e3,1e6,1e9,1e12];W=logspace(-2,2);
nyquist(L,'k-.');hold;
[K,SVL,W1]=ltrsyn(G,F,XI,THETA,RHO,W);
```

See also `ltrdemo`

### Limitations

The `ltrsyn` procedure may fail for non-minimum phase plants. For full-state LTR (default `OPT='INPUT'`), the plant should not have fewer outputs than inputs. Conversely for filter LTR (when `OPT='OUTPUT'`), the plant should not have fewer inputs than outputs. The plant must be strictly proper, i.e., the  $D$ -matrix of the plant should be all zeros. `ltrsyn` is only for continuous time plants (`Ts==0`)

### References

[1] J. Doyle and G. Stein “Multivariable Feedback Design: Concepts for a Classical/Modern Synthesis,” *IEEE Trans. on Automat. Contr.*, AC-26, pp. 4-16, 1981.

# ltrsyn

---

## See Also

h2syn

$H_2$  controller synthesis

hinfosyn

$H_\infty$  controller synthesis

lqg

Continuous linear-quadratic-Gaussian control synthesis

loopsyn

$H_\infty$  - loop shaping controller synthesis

ltrdemo

Demo of LQG/LTR optimal control synthesis

ncfsyn

$H_\infty$  - normalized coprime controller synthesis

|                      |                                                                                                                                                                                                                                                                                                                                                                                                        |                     |                                                                 |                      |                                                                                 |                      |                                                                                    |
|----------------------|--------------------------------------------------------------------------------------------------------------------------------------------------------------------------------------------------------------------------------------------------------------------------------------------------------------------------------------------------------------------------------------------------------|---------------------|-----------------------------------------------------------------|----------------------|---------------------------------------------------------------------------------|----------------------|------------------------------------------------------------------------------------|
| <b>Purpose</b>       | Return the number of matrix variables in a system of LMIs                                                                                                                                                                                                                                                                                                                                              |                     |                                                                 |                      |                                                                                 |                      |                                                                                    |
| <b>Syntax</b>        | $K = \text{matnbr}(\text{lmissys})$                                                                                                                                                                                                                                                                                                                                                                    |                     |                                                                 |                      |                                                                                 |                      |                                                                                    |
| <b>Description</b>   | <code>matnbr</code> returns the number $K$ of matrix variables in the LMI problem described by <code>lmissys</code> .                                                                                                                                                                                                                                                                                  |                     |                                                                 |                      |                                                                                 |                      |                                                                                    |
| <b>See Also</b>      | <table><tr><td><code>decnbr</code></td><td>Give the total number of decision variables in a system of LMIs</td></tr><tr><td><code>lmiinfo</code></td><td>Interactively retrieve information about the variables and term content of LMIs</td></tr><tr><td><code>decinfo</code></td><td>Describe how the entries of a matrix variable <math>X</math> relate to the decision variables</td></tr></table> | <code>decnbr</code> | Give the total number of decision variables in a system of LMIs | <code>lmiinfo</code> | Interactively retrieve information about the variables and term content of LMIs | <code>decinfo</code> | Describe how the entries of a matrix variable $X$ relate to the decision variables |
| <code>decnbr</code>  | Give the total number of decision variables in a system of LMIs                                                                                                                                                                                                                                                                                                                                        |                     |                                                                 |                      |                                                                                 |                      |                                                                                    |
| <code>lmiinfo</code> | Interactively retrieve information about the variables and term content of LMIs                                                                                                                                                                                                                                                                                                                        |                     |                                                                 |                      |                                                                                 |                      |                                                                                    |
| <code>decinfo</code> | Describe how the entries of a matrix variable $X$ relate to the decision variables                                                                                                                                                                                                                                                                                                                     |                     |                                                                 |                      |                                                                                 |                      |                                                                                    |

# mat2dec

**Purpose** Return the vector of decision variables corresponding to particular values of the matrix variables

**Syntax** `decvec = mat2dec(lmisys,X1,X2,X3,...)`

**Description** Given an LMI system `lmisys` with matrix variables  $X_1, \dots, X_K$  and given values  $X_1, \dots, X_k$  of  $X_1, \dots, X_K$ , `mat2dec` returns the corresponding value `decvec` of the vector of decision variables. Recall that the decision variables are the independent entries of the matrices  $X_1, \dots, X_K$  and constitute the free scalar variables in the LMI problem.

This function is useful, for example, to initialize the LMI solvers `mincx` or `gevp`. Given an initial guess for  $X_1, \dots, X_K$ , `mat2dec` forms the corresponding vector of decision variables `xinit`.

An error occurs if the dimensions and structure of  $X_1, \dots, X_k$  are inconsistent with the description of  $X_1, \dots, X_K$  in `lmisys`.

**Example** Consider an LMI system with two matrix variables  $X$  and  $Y$  such that

- $X$  is A symmetric block diagonal with one 2-by-2 full block and one 2-by-2 scalar block
- $Y$  is a 2-by-3 rectangular matrix

Particular instances of  $X$  and  $Y$  are

$$X_0 = \begin{pmatrix} 1 & 3 & 0 & 0 \\ 3 & -1 & 0 & 0 \\ 0 & 0 & 5 & 0 \\ 0 & 0 & 0 & 5 \end{pmatrix}, \quad Y_0 = \begin{pmatrix} 1 & 2 & 3 \\ 4 & 5 & 6 \end{pmatrix}$$

and the corresponding vector of decision variables is given by

```
decv = mat2dec(lmisys,X0,Y0)
```

```
decv'
```

```
ans =
```

```
1 3 -1 5 1 2 3 4 5 6
```

Note that `decv` is of length 10 since  $Y$  has 6 free entries while  $X$  has 4 independent entries due to its structure. Use `decinfo` to obtain more information about the decision variable distribution in  $X$  and  $Y$ .

**See Also**

|                      |                                                                                                 |
|----------------------|-------------------------------------------------------------------------------------------------|
| <code>dec2mat</code> | Given values of the decision variables, derive the corresponding values of the matrix variables |
| <code>decinfo</code> | Describe how the entries of a matrix variable $X$ relate to the decision variables              |
| <code>decnbr</code>  | Give the total number of decision variables in a system of LMIs                                 |

# mincx

---

**Purpose** Minimize a linear objective under LMI constraints

**Syntax** `[copt,xopt] = mincx(lmisys,c,options,xinit,target)`

**Description** The function `mincx` solves the convex program

$$\text{minimize } c^T x \text{ subject to } \mathcal{N} \mathcal{L}(x) \mathcal{N} \leq \mathcal{M}^T \mathcal{R}(x) \mathcal{M} \quad (10-18)$$

where  $x$  denotes the vector of scalar decision variables.

The system of LMIs (9-18) is described by `lmisys`. The vector  $c$  must be of the same length as  $x$ . This length corresponds to the number of decision variables returned by the function `decnbr`. For linear objectives expressed in terms of the matrix variables, the adequate  $c$  vector is easily derived with `decx`.

The function `mincx` returns the global minimum `copt` for the objective  $c^T x$ , as well as the minimizing value `xopt` of the vector of decision variables. The corresponding values of the matrix variables is derived from `xopt` with `dec2mat`.

The remaining arguments are optional. The vector `xinit` is an initial guess of the minimizer `xopt`. It is ignored when infeasible, but may speed up computations otherwise. Note that `xinit` should be of the same length as  $c$ . As for `target`, it sets some target for the objective value. The code terminates as soon as this target is achieved, that is, as soon as some feasible  $x$  such that  $c^T x \leq \text{target}$  is found. Set `options` to `[]` to use `xinit` and `target` with the default options.

**Control Parameters** The optional argument `options` gives access to certain control parameters of the optimization code. In `mincx`, this is a five-entry vector organized as follows:

- `options(1)` sets the desired relative accuracy on the optimal value `lopt` (default =  $10^{-2}$ ).
- `options(2)` sets the maximum number of iterations allowed to be performed by the optimization procedure (100 by default).
- `options(3)` sets the feasibility radius. Its purpose and usage are as for `feasp`.



- options(4) helps speed up termination. If set to an integer value  $J > 0$ , the code terminates when the objective  $c^T x$  has not decreased by more than the desired relative accuracy during the last  $J$  iterations.
- options(5) = 1 turns off the trace of execution of the optimization procedure. Resetting options(5) to zero (default value) turns it back on.

Setting option(i) to zero is equivalent to setting the corresponding control parameter to its default value. See feasp for more detail.

### Tip for Speed-Up

In LMI optimization, the computational overhead per iteration mostly comes from solving a least-squares problem of the form

$$\min_x \|Ax - b\|$$

where  $x$  is the vector of decision variables. Two methods are used to solve this problem: Cholesky factorization of  $A^T A$  (default), and QR factorization of  $A$  when the normal equation becomes ill conditioned (when close to the solution typically). The message

```
* switching to QR
```

is displayed when the solver has to switch to the QR mode.

Since QR factorization is incrementally more expensive in most problems, it is sometimes desirable to prevent switching to QR. This is done by setting options(4) = 1. While not guaranteed to produce the optimal value, this generally achieves a good trade-off between speed and accuracy.

### Memory Problems

QR-based linear algebra (see above) is not only expensive in terms of computational overhead, but also in terms of memory requirement. As a result, the amount of memory required by QR may exceed your swap space for large problems with numerous LMI constraints. In such case, MATLAB issues the error

```
??? Error using ==> pds
Out of memory. Type HELP MEMORY for your options.
```

You should then ask your system manager to increase your swap space or, if no additional swap space is available, set options(4) = 1. This will prevent

switching to QR and mincx will terminate when Cholesky fails due to numerical instabilities.

## Reference

The solver mincx implements Nesterov and Nemirovski's Projective Method as described in

Nesterov, Yu, and A. Nemirovski, *Interior Point Polynomial Methods in Convex Programming: Theory and Applications*, SIAM, Philadelphia, 1994.

Nemirovski, A., and P. Gahinet, "The Projective Method for Solving Linear Matrix Inequalities," *Proc. Amer. Contr. Conf.*, 1994, Baltimore, Maryland, pp. 840–844.

The optimization is performed by the C-MEX file `pds.mex`.

## See Also

|                      |                                                                                                 |
|----------------------|-------------------------------------------------------------------------------------------------|
| <code>defcx</code>   | Help specify $c^T x$ objectives for the mincx solver                                            |
| <code>dec2mat</code> | Given values of the decision variables, derive the corresponding values of the matrix variables |
| <code>decnbr</code>  | Give the total number of decision variables in a system of LMIs                                 |
| <code>feasp</code>   | Find a solution to a given system of LMIs                                                       |
| <code>gevp</code>    | Generalized eigenvalue minimization under LMI constraints                                       |

**Purpose**  $H_\infty$  mixed-sensitivity synthesis method for robust control loopshaping design

**Syntax** `[K,CL,GAM,INFO]=mixsyn(G,W1,W2,W3)`  
`[K,CL,GAM,INFO]=mixsyn(G,W1,W2,W3,KEY1,VALUE1,KEY2,VALUE2,...)`

**Description** `[K,CL,GAM,INFO]=mixsyn(G,W1,W2,W3)` computes a controller  $K$  that minimizes the  $H_\infty$  norm of the closed-loop transfer function the weighted mixed sensitivity

$$T_{y_1 u_1} \triangleq \begin{bmatrix} W_1 S \\ W_2 R \\ W_3 T \end{bmatrix}$$

where  $S$  and  $T$  are called the *sensitivity* and *complementary sensitivity*, respectively and  $S$ ,  $R$  and  $T$  are given by

$$S = (I + GK)^{-1}$$

$$R = K(I + GK)^{-1}$$

$$T = GK(I + GK)^{-1}$$

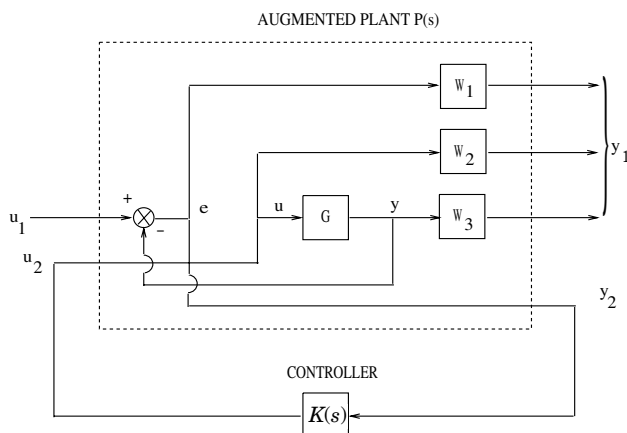

**Figure 10-13:** Closed-loop transfer function  $T_{y_1 u_1}$  for mixed sensitivity mixsyn.

The returned values of S, R, and T satisfy the following loop shaping inequalities:

$$\bar{\sigma}(S(j\omega)) \leq \gamma \underline{\sigma}(W_1^{-1}(j\omega))$$

$$\bar{\sigma}(R(j\omega)) \leq \gamma \underline{\sigma}(W_2^{-1}(j\omega))$$

$$\bar{\sigma}(T(j\omega)) \leq \gamma \underline{\sigma}(W_3^{-1}(j\omega))$$

where  $\gamma = \text{GAM}$ . Thus,  $W_1, W_2, W_3$  determine the shapes of sensitivity S and complementary sensitivity T. Typically, you would choose  $W_1$  to be small inside the desired control bandwidth to achieve good disturbance attenuation (i.e., performance), and choose  $W_3$  to be small outside the control bandwidth, which helps to ensure good stability margin (i.e., robustness).

For dimensional compatibility, each of the three weights  $W_1, W_2$  and  $W_3$  must be either empty, scalar (SISO) or have respective input dimensions  $N_Y, N_U$ , and  $N_Y$  where  $G$  is  $N_Y$ -by- $N_U$ . If one of the weights is not needed, you may simply assign an empty matrix []; e.g.,  $P = \text{AUGW}(G, W_1, [], W_3)$  is SYS but without the second row (without the row containing  $W_2$ ).

## Algorithm

```
[K, CL, GAM, INFO] = mixsyn(G, W1, W2, W3, KEY1, VALUE1, KEY2, VALUE2, ...)
```

is equivalent to

```
[K, CL, GAM, INFO] = ...
    hinfsyn((G, W1, W2, W3), KEY1, VALUE1, KEY2, VALUE2, ...)
```

mixsyn accepts all the same key value pairs as hinfsyn.

## Example

The following code illustrates the use of mixsyn for sensitivity and complementary sensitivity 'loop-shaping'.

```
s = zpk('s');
G = (s-1)/(s+1)^2;
W1 = 0.1*(s+100)/(100*s+1); W2 = 0.1;
[K, CL, GAM] = mixsyn(G, W1, W2, []);
L = G*K; S = inv(1+L); T = 1-S;
sigma(S, 'g', T, 'r', GAM/W1, 'g-.', GAM*G/ss(W2), 'r-.')
```

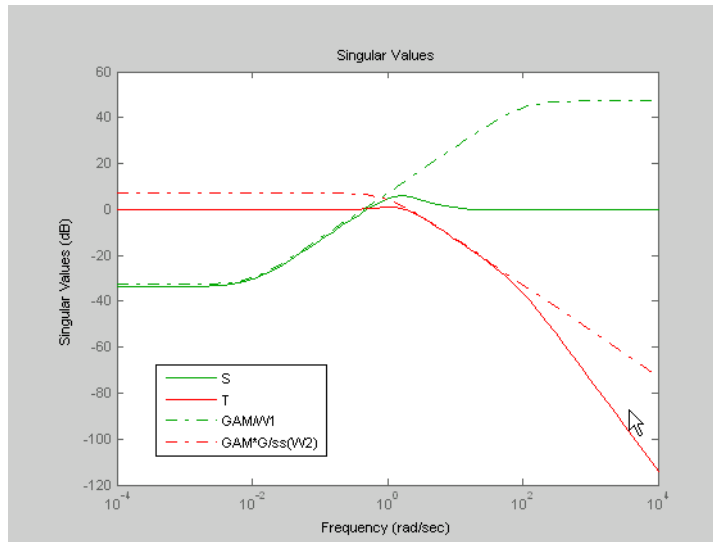

**Figure 10-14:** `mixsyn(G,W1,W2,[ ])` shapes sigma plots of  $S$  and  $T$  to conform to  $\gamma/W_1$  and  $\gamma G/W_2$ , respectively.

**Limitations**

The transfer functions  $G$ ,  $W_1$ ,  $W_2$  and  $W_3$  must be proper, i.e., bounded as  $s \rightarrow \infty$  or, in the discrete-time case, as  $z \rightarrow \infty$ . Additionally,  $W_1$ ,  $W_2$  and  $W_3$  should be stable. The plant  $G$  should be stabilizable and detectable; else,  $P$  will not be stabilizable by any  $K$ .

**See Also**

|                      |                                           |
|----------------------|-------------------------------------------|
| <code>augw</code>    | Augments plant weights for control design |
| <code>hinfsyn</code> | $H_\infty$ controller synthesis           |

# mkfilter

---

**Purpose** Generate a Bessel, Butterworth, Chebyshev or RC filter

**Syntax**

```
sys = mkfilter(fc,ord,type)
sys = mkfilter(fc,ord,type,psbndr)
```

**Description** `sys = mkfilter(fc,ord,type)` returns a single-input, single-output analog low-pass filter, `sys` as an ss object. The cutoff frequency (Hertz) is `fc` and the filter order is `ord`, a positive integer. The string variable, `type`, specifies the type of filter and can be one of the following

| <b>type, String variable</b> | <b>Description</b>                   |
|------------------------------|--------------------------------------|
| 'butterw'                    | Butterworth filter                   |
| 'cheby'                      | Chebyshev filter                     |
| 'bessel'                     | Bessel filter                        |
| 'rc'                         | Series of resistor/capacitor filters |

The dc gain of each filter (except even order Chebyshev) is set to unity.

`sys = mkfilter(fc,ord,type,psbndr)` contains the input argument `psbndr` that specifies the Chebyshev passband ripple (in dB). At the cutoff frequency, the magnitude is `-psbndr` dB. For even order Chebyshev filters the DC gain is also `-psbndr` dB.

**Example**

```
butw = mkfilter(2,4,'butterw');
cheb = mkfilter(4,4,'cheby',0.5);
rc = mkfilter(1,4,'rc');
bode(butw_g,'-',cheb_g,'--',rc_g,'-.')
```

```
megend('Butterworth','Chebyshev','RC filter')
```

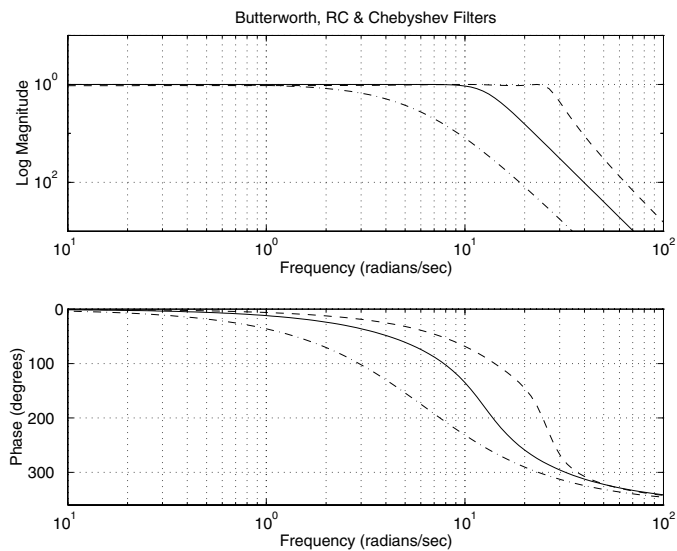

## Limitations

The Bessel filters are calculated using the recursive polynomial formula. This is poorly conditioned for high order filters (order > 8).

## See Also

augw

Augments plant weights for control design

# mktito

**Purpose** Make a TITO (two-input-two-output) system out of a MIMO LTI system

**Syntax** `SYS=mktito(SYS,NMEAS,NCONT)`

**Description** `SYS=mktito(SYS,NMEAS,NCONT)` adds TITO (two-input-two-output) partitioning to LTI system `SYS`, assigning `OutputGroup` and `InputGroup` properties such that

$$NMEAS = \dim(y_2)$$

$$NCONT = \dim(u_2)$$

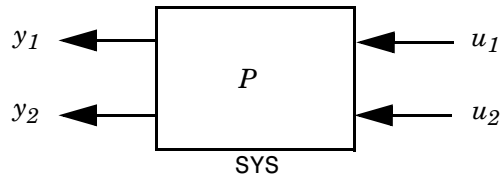

Any pre-existing `OutputGroup` or `InputGroup` properties of `SYS` are overwritten. TITO partitioning simplifies syntax for control synthesis functions like `hinfsyn` and `h2syn`.

**Algorithm**

```
[r,c]=size(SYS);
set(SYS,'InputGroup', struct('U1',1:c-NCONT,'U2',c-NCONT+1:c));
set(SYS,'OutputGroup',struct('Y1',1:r-NMEAS,'Y2',r-NMEAS+1:r));
```

**Example** You can type

```
P=rss(2,4,5); P=mktito(P,2,2);
disp(P.OutputGroup); disp(P.InputGroup);
```

to create a 4-by-5 LTI system `P` with `OutputGroup` and `InputGroup` properties

```
U1: [1 2 3]
```

```
U2: [4 5]
```

```
Y1: [1 2]
```

```
Y2: [3 4]
```

**See also** `augw` Augments plant weights for control design  
`hinfsyn`  $H_\infty$  synthesis controller



h2syn  
ltiprops  
sdhinfyn

$H_2$  synthesis controller  
Help on LTI model properties  
 $H_\infty$  discrete-time controller

# modreal

**Purpose** Modal form realization and projection

**Syntax** `[G1,G2] = modreal(G,cut)`

**Description** `[G1,G2] = modreal(G,cut)` returns a set of state-space LTI objects G1 and G2 in modal form given a state-space G and the model size of G1, cut.

The modal form realization has its A matrix in block diagonal form with either 1x1 or 2x2 blocks. The real eigenvalues will be put in 1x1 blocks and complex eigenvalues will be put in 2x2 blocks. These diagonal blocks are ordered in ascending order based on eigenvalue magnitudes.

The complex eigenvalue  $a+bj$  is appearing as 2x2 block

$$\begin{bmatrix} a & b \\ -b & a \end{bmatrix}$$

This table describes input arguments for `modreal`.

| Argument | Description                                                                                               |
|----------|-----------------------------------------------------------------------------------------------------------|
| G        | LTI model to be reduced.                                                                                  |
| cut      | (Optional) an integer to split the realization. Without it, a complete modal form realization is returned |

This table lists output arguments.

| Argument | Description              |
|----------|--------------------------|
| G1,G2    | LTI models in modal form |

G can be stable or unstable.  $G_1 = (A_1, B_1, C_1, D_1)$ ,  $G_2 = (A_2, B_2, C_2, D_2)$  and  $D_1 = D + C_2(-A_2)^{-1}B_2$  is calculated such that the system DC gain is preserved.

**Algorithm** Using a real eigen structure decomposition `reig` and ordering the eigenvectors in ascending order according to their eigenvalue magnitudes, we can form a

similarity transformation out of these ordered real eigenvectors such that the resulting systems G1 and/or G2 are in block diagonal modal form.

**Note** This routine is extremely useful when model has  $j\omega$ -axis singularities, e.g., rigid body dynamics. It has been incorporated inside Hankel based model reduction routines - `hankelmr`, `balancmr`, `bstmr`, and `schurmr` to isolate those  $j\omega$ -axis poles from the actual model reduction process.

### Example

Given a continuous stable or unstable system, G, the following commands can get a set of modal form realizations depending on the split index -- cut:

```
randn('state',1234); rand('state',5678);
G = rss(50,2,2);
[G1,G2] = modreal(G,2); % cut = 2 for two rigid body modes
G1.d = zeros(2,2); % remove the DC gain of the system from G1
sigma(G,G1,G2)
```

### See Also

|                       |                                                    |
|-----------------------|----------------------------------------------------|
| <code>reduce</code>   | Top level model reduction routines                 |
| <code>balancmr</code> | Balanced truncation via square-root method         |
| <code>schurmr</code>  | Balanced truncation via Schur method               |
| <code>bstmr</code>    | Balanced stochastic truncation via Schur method    |
| <code>ncfmr</code>    | Balanced truncation for normalized coprime factors |
| <code>hankelmr</code> | Hankel minimum degree approximation                |
| <code>hankelsv</code> | Hankel singular value                              |

**Purpose** Multi-model/multi-objective state-feedback synthesis

**Syntax** `[gopt,h2opt,K,Pc1,X] = msfsyn(P,r,obj,region,tol)`

**Description** Given an LTI plant P with state-space equations

$$\begin{cases} \dot{x} &= Ax + B_1w + B_2u \\ z_\infty &= C_1x + D_{11}w + D_{12}u \\ z_2 &= C_2x + D_{22}u \end{cases}$$

msfsyn computes a state-feedback control  $u = Kx$  that

- Maintains the RMS gain ( $H_\infty$  norm) of the closed-loop transfer function  $T_\infty$  from  $w$  to  $z_\infty$  below some prescribed value  $\gamma_0 > 0$
- Maintains the  $H_2$  norm of the closed-loop transfer function  $T_2$  from  $w$  to  $z_2$  below some prescribed value  $v_0 > 0$
- Minimizes an  $H_2/H_\infty$  trade-off criterion of the form

$$\alpha \|T_\infty\|_\infty^2 + \beta \|T_2\|_2^2$$

- Places the closed-loop poles inside the LMI region specified by region (see `lmireg` for the specification of such regions). The default is the open left-half plane.

Set  $r = \text{size}(d22)$  and  $\text{obj} = [\gamma_0, v_0, \alpha, \beta]$  to specify the problem dimensions and the design parameters  $\gamma_0$ ,  $v_0$ ,  $\alpha$ , and  $\beta$ . You can perform pure pole placement by setting  $\text{obj} = [0 \ 0 \ 0 \ 0]$ . Note also that  $z_\infty$  or  $z_2$  can be empty.

On output, `gopt` and `h2opt` are the guaranteed  $H_\infty$  and  $H_2$  performances,  $K$  is the optimal state-feedback gain,  $Pc1$  the closed-loop transfer function from  $w$

to  $\begin{pmatrix} z_\infty \\ z_2 \end{pmatrix}$ , and  $X$  the corresponding Lyapunov matrix.

The function `msfsyn` is also applicable to multi-model problems where  $P$  is a polytopic model of the plant:

$$\begin{cases} \dot{x} &= A(t)x + B_1(t)w + B_2(t)u \\ z_\infty &= C_1(t)x + D_{11}(t)w + D_{12}(t)u \\ z_2 &= C_2(t)x + D_{22}(t)u \end{cases}$$

with time-varying state-space matrices ranging in the polytope

$$\begin{pmatrix} A(t) & B_1(t) & B_2(t) \\ C_1(t) & D_{11}(t) & D_{12}(t) \\ C_2(t) & 0 & D_{22}(t) \end{pmatrix} \in \text{Co} \left\{ \begin{pmatrix} A_k & B_k & B_{2k} \\ C_{1k} & D_{11k} & D_{12k} \\ C_{2k} & 0 & D_{22k} \end{pmatrix} : k = 1, \dots, K \right\}$$

In this context, `msfsyn` seeks a state-feedback gain that robustly enforces the specifications over the entire polytope of plants. Note that polytopic plants should be defined with `psys` and that the closed-loop system `Pc1` is itself polytopic in such problems. Affine parameter-dependent plants are also accepted and automatically converted to polytopic models.

## See Also

`lmireg`  
`psys`

Specify LMI regions for pole placement purposes  
Specification of uncertain state-space models

# mussv

---

**Purpose** Compute upper and lower bounds on the Structured Singular Value ( $\mu$ ) and upper bounds on Generalized structured singular value

**Syntax**

```
bounds = mussv(M,BlockStructure)
[bounds,muinfo] = mussv(M,BlockStructure)
[bounds,muinfo] = mussv(M,BlockStructure,Options)
[ubound,q] = mussv(M,F,BlockStructure)
[ubound,q] = mussv(M,F,BlockStructure,'s')
```

**Description** `bounds = mussv(M,BlockStructure)` calculates upper and lower bounds on the structured singular value, or  $\mu$ , for a given block structure. `M` is a double, or `frd` object. If `M` is an `N-D` array (with  $N \geq 3$ ), then the computation is performed pointwise along the third and higher array dimensions. If `M` is a `frd` object, the computations are performed pointwise in frequency (as well as any array dimensions).

`BlockStructure` is a matrix specifying the perturbation block structure. `BlockStructure` has 2 columns, and as many rows as uncertainty blocks in the perturbation structure. The  $i$ -th row of `BlockStructure` defines the dimensions of the  $i$ 'th perturbation block.

- If `BlockStructure(i,:) = [r 0]`, then the  $i$ -th block is a  $r$ -by- $r$  repeated, diagonal real scalar perturbation;
- if `BlockStructure(i,:) = [r 0]`, then the  $i$ -th block is a  $r$ -by- $r$  repeated, diagonal complex scalar perturbation;
- if `BlockStructure(i,:) = [r c]`, then the  $i$ -th block is a  $r$ -by- $c$  complex full-block perturbation.
- If `BlockStructure` is omitted, its default is `ones(size(M,1),2)`, which implies a perturbation structure of all 1-by-1 complex blocks. In this case, if `size(M,1)` does not equal `size(M,2)`, an error results.

If `M` is a 2-dimensional matrix, then `bounds` is a `1x2` array containing an upper (1st column) and lower (2nd column) bound of structured singular value of `M`. For all matrices `Delta` with block-diagonal structure defined by `BlockStructure` and with norm less than `1/bounds(1)` (upper bound), the matrix `I - M*Delta` is not singular. Moreover, there is a matrix `DeltaS` with block-diagonal structure defined by `BlockStructure` and with norm equal to `1/bounds(2)` (lower bound), for which the matrix `I - M*DeltaS` is singular.

If  $M$  is an `frd`, the computations are always performed pointwise in frequency. The output argument `bounds` is a 1-by-2 `frd` of upper and lower bounds at each frequency. Note that `bounds.Frequency` equals `M.Frequency`.

If  $M$  is an N-D array (either `double` or `frd`), the upper and lower bounds are computed pointwise along the 3rd and higher array dimensions (as well as pointwise in frequency, for `frd`). For example, suppose that `size(M)` is  $r \times c \times d_1 \times \dots \times d_F$ . Then `size(bounds)` is  $1 \times 2 \times d_1 \times \dots \times d_F$ . Using single index notation, `bounds(1,1,i)` is the upper bound for the structured singular value of  $M(:, :, i)$ , and `bounds(1,2,i)` is the lower bound for the structured singular value of  $M(:, :, i)$ . Here, any  $i$  between 1 and  $d_1 d_2 \dots d_F$  (the product of the  $d_k$ ) would be valid.

`bounds = mussv(M,BlockStructure,Options)` specifies computation options. `Options` is a character string, containing any combination of the following characters:

| Option | Meaning                                                                                                                                     |
|--------|---------------------------------------------------------------------------------------------------------------------------------------------|
| 'a'    | Upper bound to greatest accuracy, using LMI solver                                                                                          |
| 'an'   | Same as 'a', but without automatic-prescaling                                                                                               |
| 'd'    | Display warnings                                                                                                                            |
| 'f'    | Fast upper bound (typically not as tight as the default)                                                                                    |
| 'i'    | Initialize lower bound computation using previous matrix (only relevant if $M$ is ND array or FRD)                                          |
| 'm7'   | Randomly initialize lower bound iteration multiple times (in this case 7 times, use 1-9), larger number typically gives better lower bound. |
| 's'    | Suppress progress information (silent)                                                                                                      |
| 'x'    | Decrease iterations in lower bound computation (faster but not as tight as default)                                                         |

`[bounds,muinfo] = mussv(M,BlockStructure)` returns `muinfo`, a structure containing more detailed information. The information within `muinfo` must be extracted using `mussvextract`. See `mussvextract` for more details.

**Generalized Structured Singular Value**

`ubound = mussv(M,F,BlockStructure)` calculates an upper bound on the generalized structured singular value (generalized  $\mu$ ) for a given block structure. `M` is a double or `frd` object. `M` and `BlockStructure` are as before. `F` is an additional (double or `frd`).

`ubound = mussv(M,F,BlockStructure, 's')` adds an option to run silently. Other options will be ignored for generalized  $\mu$  problems.

Note that in generalized structured singular value computations, only an upper bound is calculated. `ubound` is an upper bound of the generalized structured singular value of the pair  $(M,F)$ , with respect to the block-diagonal uncertainty described by `BlockStructure`. Consequently `ubound` is 1-by-1 (with additional array dependence, depending on `M` and `F`). For all matrices `Delta` with block-diagonal structure defined by `BlockStructure` and  $\text{norm}(\Delta)/\text{ubound} < 1$ , the matrix  $[I - \Delta * M; F]$  is guaranteed not to lose column rank. This is verified by the matrix `Q`, which satisfies `mussv(M+Q*F,BlockStructure, 'C') <= ubound`.

**Example**

See `mussvextract` for a detailed example of the structured singular value.

A simple example for generalized structured singular value can be done with random complex matrices, illustrating the relationship between the upper bound for  $\mu$  and generalized  $\mu$ , as well as the fact that the upper bound for generalized  $\mu$  comes from an optimized  $\mu$  upper bound.

`M` is a complex 5-by-5 matrix and `F` is a complex 2-by-5 matrix. The block structure, `BlockStructure`, is an uncertain real parameter  $\delta_1$ , an uncertain real parameter  $\delta_2$ , an uncertain complex parameter  $\delta_3$  and a twice repeated uncertain complex parameter  $\delta_4$ .

```
M = randn(5,5) + sqrt(-1)*randn(5,5);
F = randn(2,5) + sqrt(-1)*randn(2,5);
BlockStructure = [-1 0;-1 0;1 1;2 0];
[ubound,Q] = mussv(M,F,BlockStructure);
points completed (of 1) ... 1
bounds = mussv(M,BlockStructure);
optbounds = mussv(M+Q*F,BlockStructure, 'C5');
```

The quantities `optbounds(1)` and `ubound` should be extremely close, and significantly lower than `bounds(1)` and `bounds(2)`.



```
[optbounds(1) ubound]
ans =
    1.5917    1.5925
[bounds(1) bounds(2)]
ans =
    3.8184    3.7135
```

## Algorithm

The lower bound is computed using a power method, Young and Doyle 1990 and Packard *et. al.* 1988, and the upper bound is computed using the balanced/AMI technique, Young *et. al.*, 1992, for computing the upper bound from Fan *et. al.*, 1991.

Peter Young and Matt Newlin wrote the original M-files.

The lower-bound power algorithm is from Young and Doyle, 1990, and Packard *et. al.* 1988.

The upper-bound is an implementation of the bound from Fan *et. al.*, 1991, and is described in detail in Young *et. al.*, 1992. In the upper bound computation, the matrix is first balanced using either a variation of Osborne’s method (Osborne, 1960) generalized to handle *repeated scalar* and *full* blocks, or a Perron approach. This generates the standard upper bound for the associated complex  $\mu$  problem. The Perron eigenvector method is based on an idea of Safonov, (Safonov, 1982). It gives the exact computation of  $\mu$  for positive matrices with scalar blocks, but is comparable to Osborne on general matrices. Both the Perron and Osborne methods have been modified to handle *repeated scalar* and *full* blocks. Perron is faster for small matrices but has a growth rate of  $n^3$ , compared with less than  $n^2$  for Osborne. This is partly due to the MATLAB implementation, which greatly favors Perron. The default is to use Perron for simple block structures and Osborne for more complicated block structures. A sequence of improvements to the upper bound is then made based on various equivalent forms of the upper bound. A number of descent techniques are used which exploit the structure of the problem, concluding with general purpose LMI optimization (Boyd *et. al.*), 1993, to obtain the final answer.

The optimal choice of  $Q$  (to minimize the upper bound) in the generalized  $\mu$  problem is solved by reformulating the optimization into a semidefinite program (Packard, etal, 1991).

## Reference

- Boyd, S. and L. El Ghaoui, “Methods of centers for minimizing generalized eigenvalues,” *Linear Algebra and Its Applications*, vol. 188–189, pp. 63–111, 1993.
- Fan, M. A. Tits, and J. Doyle, “Robustness in the presence of mixed parametric uncertainty and unmodeled dynamics,” *IEEE Transactions on Automatic Control*, vol. AC–36, pp. 25–38, 1991.
- Osborne, E. “On preconditioning of matrices,” *Journal of Associated Computer Machines*, vol. 7, pp. 338–345, 1960.
- Packard, A.K., M. Fan and J. Doyle, “A power method for the structured singular value,” *Proc. of 1988 IEEE Conference on Control and Decision*, pp. 2132–2137, December 1988.
- Safonov, M. “Stability margins for diagonally perturbed multivariable feedback systems,” *IEEE Proc.*, vol. 129, Part D, pp. 251–256, 1982.
- Young, P. and J. Doyle, “Computation of with real and complex uncertainties,” *Proceedings of the 29th IEEE Conference on Decision and Control*, pp. 1230–1235, 1990.
- Young, P., M. Newlin, and J. Doyle, “Practical computation of the mixed problem,” *Proceedings of the American Control Conference*, pp. 2190–2194, June, 1992.

## See Also

|              |                                                      |
|--------------|------------------------------------------------------|
| loopmargin   | Comprehensive analysis of feedback loop              |
| mussvextract | Extract compressed data returned from mussv          |
| robuststab   | Calculate stability margins of uncertain systems     |
| robustperf   | Calculate performance margins of uncertain systems   |
| wcgain       | Calculate worst-case gain of a system                |
| wcsens       | Calculate worst-case sensitivities for feedback loop |
| wcmargin     | Calculate worst-case margins for feedback loop       |

**Purpose** Extracts the muinfo structure returned by mussv

**Syntax** [VDelta, VSigma, VLmi] = mussvextract(muinfo)

**Description** A structured singular value computation of the form  

$$[\text{bounds}, \text{muinfo}] = \text{mussv}(\text{M}, \text{BlockStructure})$$

returns detailed information in the structure muinfo. mussvextract is used to extract the compressed information within muinfo into a readable form.

The most general call to mussvextract extracts three usable quantities: VDelta, VSigma, and VLmi. VDelta is used to verify the lower bound. VSigma is used to verify the Newlin/Young upper bound and has fields DLeft, DRight, GLeft, GMiddle, and GRight. VLmi is used to verify the LMI upper bound and has fields Dr, Dc, Grc, and Gcr. The relation/interpretation of these quantities with the numerical results in bounds is described below.

**Upper Bound Information**

The upper bound is based on a proof that  $\det(I - M \cdot \Delta)$  is nonzero for all block-structured matrices Delta with norm smaller than  $1/\text{bounds}(1)$ . The Newlin/Young method consists of finding a scalar  $\beta$  and matrices  $D$  and  $G$ , consistent with BlockStructure, such that

$$\bar{\sigma} \left( (I + G_l^2)^{-\frac{1}{4}} \left( \frac{D_r^{-1}}{\beta} - jG_m \right) (I + G_r^2)^{-\frac{1}{4}} \right) \leq 1$$

Since some uncertainty blocks and M need not be square, the matrices  $D$  and  $G$  have a few different manifestations. In fact, in the formula above, there is a left and right  $D$  and  $G$ , as well as a middle  $G$ . Any such  $\beta$  is an upper bound of  $\text{mussv}(\text{M}, \text{BlockStructure})$ .

It is true that if BlockStructure consists only of complex blocks, then all  $G$  matrices will be zero, and the expression above simplifies to

$$\bar{\sigma}(D_r^{-1}) \leq \beta.$$

The LMI method consists of finding a scalar  $\beta$  and matrices  $D$  and  $G$ , consistent with BlockStructure, such that

# mussvextract

$$M'D_{rM} - \beta^2 D_c + j*(G_{cr}M - M'G_{rc})$$

is negative semidefinite. Again,  $D$  and  $G$  have a few different manifestations to match the row and column dimensions of  $M$ . Any such  $\beta$  is an upper bound of `mussv(M,BlockStructure)`. If `BlockStructure` consists only of complex blocks, then all  $G$  matrices will be zero, and negative semidefiniteness of  $M'D_{rM} - \beta^2 D_c$  is sufficient to derive an upper bound.

## Lower Bound Information

The lower bound of `mussv(M,BlockStructure)` is based on finding a “small” (hopefully the smallest) block-structured matrix `VDelta` that causes `det(I - M*VDelta)` to equal 0. Equivalently, the matrix `M*VDelta` has an eigenvalue equal to 1. It will always be true that the lower bound (`bounds(2)`) will be the reciprocal of `norm(VDelta)`.

## Example

Suppose  $M$  is a 4-by-4 complex matrix. Take the block structure to be two 1-by-1 complex blocks and one 2-by-2 complex block.

```
M = randn(4,4) + sqrt(-1)*randn(4,4);
BlockStructure = [1 1;1 1;2 2];
```

You can calculate bounds on the structured singular value using the `mussv` command and extract the scaling matrices using `mussvextract`.

```
[bounds,muinfo] = mussv(M,BlockStructure);
[VDelta,VSigma,VLmi] = mussvextract(muinfo);
```

You can first verify the Newlin/Young upper bound with the information extracted from `muinfo`. The corresponding scalings are `Dl` and `Dr`.

```
Dl = VSigma.DLeft
Dl =
    1.0000         0         0         0
         0    0.8393         0         0
         0         0    0.8917         0
         0         0         0    0.8917

Dr = VSigma.DRight
Dr =
    1.0000         0         0         0
         0    0.8393         0         0
         0         0    0.8917         0
```

```

          0          0          0    0.8917
[norm(D1*M/Dr) bounds(1)]
ans =
    4.2013    4.2013

```

You can first verify the LMI upper bound with the information extracted from muinfo. The corresponding scalings are Dr and Dc.

```

Dr = VLmi.Dr;
Dc = VLmi.Dc;
eig(M'*Dr*M - bounds(1)^2*Dc)
ans =
 -15.2960 - 0.0000i
 -0.0000 - 0.0000i
 -10.1037 + 0.0000i
 -5.9719 + 0.0000i

```

Note that VDelta matches the structure defined by BlockStructure, and the norm of VDelta agrees with the lower bound,

```

VDelta
VDelta =
    0.2009 - 0.1277i    0          0          0
          0          0.1648 - 0.1718i    0          0
          0          0          -0.0408 + 0.0773i  -0.0291
 - 0.1012i
          0          0          0.0635 - 0.1070i  0.0341
 + 0.1460i
[norm(VDelta) 1/bounds(2)]
ans =
    0.2380    0.2380

```

and that M\*VDelta has an eigenvalue exactly at 1.

```

eig(M*VDelta)
ans =
    1.0000 + 0.0000i
    0.0000 + 0.0000i
 -0.1161 + 0.0225i
 -0.0837 + 0.6532i

```

## mussvextract

---

Keep the matrix the same, but change `BlockStructure` to be a 2-by-2 repeated, real scalar block and two complex 1-by-1 blocks. Run `mussv` with the 'C' option to tighten the upper bound.

```
BlockStructure2 = [-2 0; 1 0; 1 0];  
[bounds2,muinfo2] = mussv(M,BlockStructure2,'C');
```

You can compare the computed bounds. Note that `bounds2` should be smaller than `bounds`, since the uncertainty set defined by `BlockStructure2` is a proper subset of that defined by `BlockStructure`.

```
[bounds; bounds2]  
ans =  
    4.2013    4.2009  
    4.0005    4.0005
```

You can extract the  $D$ ,  $G$  and  $\Delta$  from `muinfo2` using `mussvextract`.

```
[VDelta2,VSigma2,VLmi2] = mussvextract(muinfo2);
```

As before, you can first verify the Newlin/Young upper bound with the information extracted from `muinfo`. The corresponding scalings are  $D_l$ ,  $D_r$ ,  $G_l$ ,  $G_m$  and  $G_r$ .

```
Dl = VSigma2.DLeft;  
Dr = VSigma2.DRight;  
Gl = VSigma2.GLeft;  
Gm = VSigma2.GMiddle;  
Gr = VSigma2.GRight;  
dmd = Dl*M/Dr/bounds2(1) - sqrt(-1)*Gm;  
SL = (eye(4)+Gl*Gl)^-0.25;  
SR = (eye(4)+Gr*Gr)^-0.25;  
norm(SL*dmd*SR)  
ans =  
    1.0000
```

You can first verify the LMI upper bound with the information extracted from `muinfo`. The corresponding scalings are  $D_r$ ,  $D_c$ ,  $G_{rc}$  and  $G_{cr}$ .

```
Dr = VLmi2.Dr;  
Dc = VLmi2.Dc;  
Grc = VLmi2.Grc;  
Gcr = VLmi2.Gcr;
```

```
eig(M'*Dr*M - bounds(1)^2 *Dc + j*(Gcr*M-M'*Grc))
ans =
    -0.0075 - 0.0000i
    -0.0009 - 0.0000i
    -0.0001 - 0.0000i
    -0.0004 - 0.0000i
```

Note that VDelta2 matches the structure defined by BlockStructure, and the norm of VDelta2 agrees with the lower bound,

```
VDelta2
VDelta2 =
    0.2500         0         0         0
         0     0.2500         0         0
         0         0    -0.0130 + 0.2496i         0
         0         0         0     0.1402 + 0.2069i
[norm(VDelta2) 1/bounds2(2)]
ans =
    0.2500    0.2500
```

and that M\*VDelta2 has an eigenvalue exactly at 1.

```
eig(M*VDelta2)
ans =
    1.0000 + 0.0000i
   -0.3097 + 0.6127i
   -0.2287 + 0.0747i
   -0.2692 - 0.4897i
```

**See Also**

mussv

Calculate bounds on the Structured Singular Value ( $\mu$ )

# ncfmargin

**Purpose** Calculate the normalized coprime stability margin of the plant-controller feedback loop

**Syntax**  
[marg,freq] = ncfmargin(P,C)  
[marg,freq] = ncfmargin(P,C,tol)

**Description** [marg,freq] = ncfmargin(P,C) calculates the normalized coprime factor/gap metric robust stability margin  $b(P, C)$ , marg, of the multivariable feedback loop consisting of C in negative feedback with P. The normalized coprime factor  $b(P, C)$  is defined as

$$b(P, C) = \left\| \begin{bmatrix} I \\ C \end{bmatrix} (I - PC)^{-1} \begin{bmatrix} P & I \end{bmatrix} \right\|_{\infty}^{-1}.$$

C should only be the compensator in the feedback path, such as the *1-dof* architecture shown below (on the right). If the compensator has *2-dof* architecture shown below (on the left), you must eliminate the reference channels before calling ncfmargin. freq is the frequency associated with the upper bound on marg.

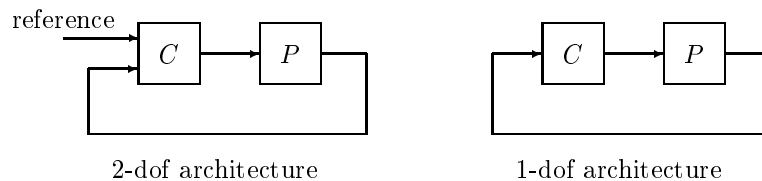

The normalized coprime factor robust stability margin lies between 0 and 1 and is used as an indication of robustness to unstructured perturbations. Values of marg greater than 0.3 generally indicate good robustness margins.

[marg,freq] = ncfmargin(P,C,tol) calculates the normalized coprime factor/gap metric robust stability of the multivariable feedback loop consisting of C in negative feedback with P. tol specifies a relative accuracy for calculating the normalized coprime factor metric and must be between  $10^{-5}$  and  $10^{-2}$ . tol=0.001 is the default value.



**Example**

Consider the plant model  $4/(s-0.001)$ , an unstable first order and two constant gain controllers,  $k_1 = 1$  and  $k_2 = 10$ . Both controllers stabilize the closed-loop system

```
x = tf(4,[1 0.001]);
clp1 = feedback(x,1)
```

The transfer function clp1 is shown as is clp2.

```
      4
-----
s + 4.001

clp2 = feedback(x,10)
```

Transfer function:

```
      4
-----
s + 40
```

The closed-loop system with controller  $k_1$ ,  $clp1$ , has a normalized coprime factor robust stability margin of 0.71 which is achieved at infinite frequency. This indicates that the closed-loop system is very robust to unstructured perturbations. The closed-loop system with controller  $k_2$ ,  $clp2$ , has a normalized coprime factor robust stability margin of 0.10. This indicates that the closed-loop system is not robust to unstructured perturbations.

```
[marg1,freq1] = ncfmargin(x,1)
marg1 =
    0.7071
freq1 =
    Inf
[marg2,freq2] = ncfmargin(x,10)
marg2 =
    0.0995
freq2 =
    Inf
```

Construct an uncertain system,  $x_u$ , by adding a 11% unmodeled dynamics to the nominal system  $x$ . Calculate the robust stability of the closed-loop system with the feedback gain 1 and 10.

```
xu = x + ultidyn('uncstruc',[1 1],'Bound',0.11);  
[stabmarg1, du1, report1] = robuststab(feedback(xu,1));  
disp(report1{1})  
Uncertain System is robustly stable to modeled uncertainty.  
-- It can tolerate up to 909% of modeled uncertainty.  
-- A destabilizing combination of 909% the modeled uncertainty  
exists, causing an instability at 165 rad/s.  
  
[stabmarg10, du10, report10] = robuststab(feedback(xu,10));  
disp(report10{1})  
Uncertain System is NOT robustly stable to modeled uncertainty.  
-- It can tolerate up to 90.9% of modeled uncertainty.  
-- A destabilizing combination of 90.9% the modeled uncertainty  
exists, causing an instability at 1.64e+003 rad/s.
```

The closed-loop system with  $K=1$  is robustly stable in the presence of the unmodeled dynamics based on the robust stability analysis. In fact, the closed-loop system with  $K=1$  can tolerate 909% (or  $9.09*11\%$ ) of the unmodeled LTI dynamics. Whereas the closed-loop system is not robustly stable with a constant gain of 10 controller. The closed-loop system with  $K=10$  implemented can only tolerate 90.9% (or  $90.9*11\%$ ) of the unmodeled LTI dynamics.

## Algorithm

The computation of the gap amounts to solving 2-block  $H_\infty$  problems, Georgiou, Smith 1988. The particular method used here for solving the  $H_\infty$  problems is based on Green et al., 1990. The computation of the nupag uses the method of Vinnicombe, 1993.

## Reference

- McFarlane, D.C. and K. Glover, Robust Controller Design using Normalised Coprime Factor Plant Descriptions, Springer Verlag, Lecture Notes in Control and Information Sciences, vol. 138, 1989.
- McFarlane, D.C., and K. Glover, "A Loop Shaping Design Procedure using Synthesis," IEEE Transactions on Automatic Control, vol. 37, no. 6, pp. 759-769, June 1992.
- Vinnicombe, G., "Measuring Robustness of Feedback Systems," PhD dissertation, Department of Engineering, University of Cambridge, 1993.

## See Also

|            |                                                    |
|------------|----------------------------------------------------|
| loopmargin | Performs a comprehensive analysis of feedback loop |
| gapmetric  | Computes the gap and the Vinnicombe gap metric     |
| norm       | Computes the norm of a system                      |

wcmargin

Calculate worst-case margins for feedback loop

# ncfmr

---

**Purpose**                   Balanced model truncation for normalized coprime factors.

**Syntax**

```
GRED = ncfmr(G)
GRED = ncfmr(G,order)
[GRED,redinfo] = ncfmr(G,key1,value1,...)
[GRED,redinfo] = ncfmr(G,order,key1,value1,...)
```

**Description**           ncfmr returns a reduced order model GRED formed by a set of balanced normalized coprime factors and a struct array redinfo containing the left and right coprime factors of G and their coprime Hankel singular values.

Hankel singular values of coprime factors of such a stable system indicate the respective “state energy” of the system. Hence, reduced order can be directly determined by examining the system Hankel SV’s.

With only one input argument G, the function will show a Hankel singular value plot of the original model and prompt for model order number to reduce.

The *left and right normalized coprime factors* are defined as [1]

- *Left Coprime Factorization:*  $G = M_l^{-1}(s)N_l(s)$
- *Right Coprime Factorization:*  $G = N_r(s)M_r^{-1}(s)$

where there exist stable  $U_r(s)$ ,  $V_r(s)$ ,  $U_l(s)$ , and  $V_l(s)$  such that

$$U_r N_r + V_r M_r = I$$

$$N_l U_l + M_l V_l = I$$

The left/right coprime factors are stable, hence implies  $M_r(s)$  should contain as RHP-zeros all the RHP-poles of  $G(s)$ . The comprimeness also implies that there should be no common RHP-zeros in  $N_r(s)$  and  $M_r(s)$ , i.e., when forming  $G = N_r(s)M_r^{-1}(s)$ , there should be no pole-zero cancellations.

This table describes input arguments for `ncfmr`.

| Argument | Description                                                                                                                        |
|----------|------------------------------------------------------------------------------------------------------------------------------------|
| G        | LTI model to be reduced (without any other inputs will plot its Hankel singular values and prompt for reduced order)               |
| ORDER    | (Optional) an integer for the desired order of the reduced model, or optionally a vector packed with desired orders for batch runs |

A batch run of a serial of different reduced order models can be generated by specifying `order = x:y`, or a vector of integers. By default, all the anti-stable part of a system is kept, because from control stability point of view, getting rid of unstable state(s) is dangerous to model a system. `ncfmr` method allows the original model to have  $j\omega$ -axis singularities.

'*MaxError*' can be specified in the same fashion as an alternative for 'ORDER'. In this case, reduced order will be determined when the sum of the tails of the Hankel sv's reaches the '*MaxError*'

| Argument            | Value                                         | Description                                                                                  |
|---------------------|-----------------------------------------------|----------------------------------------------------------------------------------------------|
| ' <i>MaxError</i> ' | A real number or a vector of different errors | Reduce to achieve $H_\infty$ error. When present, ' <i>MaxError</i> ' overrides ORDER input. |
| ' <i>Display</i> '  | ' <i>on</i> ' or ' <i>off</i> '               | Display Hankel singular plots (default ' <i>off</i> ').                                      |
| ' <i>Order</i> '    | integer, vector or cell array                 | Order of reduced model. Use only if not specified as 2nd argument.                           |

Weights on the original model input and/or output can make the model reduction algorithm focus on some frequency range of interests. But weights have to be stable, minimum phase and invertible.

This table describes output arguments.

| Argument | Description                                                                                                                                                                                                     |
|----------|-----------------------------------------------------------------------------------------------------------------------------------------------------------------------------------------------------------------|
| GRED     | LTI reduced order model, that becomes multi-dimensional array when input is a serial of different model order array.                                                                                            |
| REDINFO  | A STRUCT array with 3 fields: <ul style="list-style-type: none"> <li>• REDINFO.GL (left coprime factor)</li> <li>• REDINFO.GR (right coprime factor)</li> <li>• REDINFO.hsv (Hankel singular values)</li> </ul> |

$G$  can be stable or unstable, continuous or discrete.

## Algorithm

Given a state space  $(A, B, C, D)$  of a system and  $k$ , the desired reduced order, the following steps will produce a similarity transformation to truncate the original state space system to the  $k^{th}$  order reduced model.

- 1 Find the normalized coprime factors of  $G$  by solving Hamiltonian described in [1].

$$G_l = \begin{bmatrix} N_l & M_l \end{bmatrix}$$

$$G_r = \begin{bmatrix} N_r \\ M_r \end{bmatrix}$$

- 2 Perform  $k^{th}$  order square root balanced model truncation on  $G_l$  (or  $G_r$ ) [2].
- 3 The reduced model GRED is [2]:

$$\left[ \begin{array}{c|c} \hat{A} & \hat{B} \\ \hline \hat{C} & \hat{D} \end{array} \right] = \left[ \begin{array}{c|c} A_c - B_m C_l & B_n - B_m D_l \\ \hline C_l & D_l \end{array} \right]$$

where

$$N_l := (A_c, B_n, C_c, D_n)$$

$$M_l := (A_c, B_m, C_c, D_m)$$

$$C_l = (D_m)^{-1}C_c$$

$$D_l = (D_m)^{-1}D_n$$

## Example

Given a continuous or discrete, stable or unstable system, G, the following commands can get a set of reduced order models based on your selections:

```
rand('state',1234); randn('state',5678);
G = rss(30,5,4); G.d = zeros(5,4);
[g1, redinfo1] = ncfmr(G); % display Hankel SV plot
                        % and prompt for order (try 15:20)
[g2, redinfo2] = ncfmr(G,20);
[g3, redinfo3] = ncfmr(G,[10:2:18]);
[g4, redinfo4] = ncfmr(G,'MaxError',[0.01, 0.05]);
for i = 1:4
    figure(i); eval(['sigma(G,g' num2str(i) ');']);
end
```

## Reference

- [1] M. Vidyasagar. *Control System Synthesis - A Factorization Approach*. London: The MIT Press, 1985.
- [2] M. G. Safonov and R. Y. Chiang, "A Schur Method for Balanced Model Reduction," *IEEE Trans. on Automat. Contr.*, vol. AC-2, no. 7, July 1989, pp. 729-733.

## See Also

|          |                                                 |
|----------|-------------------------------------------------|
| reduce   | Top level model reduction routines              |
| balancmr | Balanced truncation via square-root method      |
| schurmr  | Balanced truncation via Schur method            |
| bstmr    | Balanced stochastic truncation via Schur method |
| hankelmr | Hankel minimum degree approximation             |
| hankelsv | Hankel singular value                           |

**Purpose** Loop shaping design using the Glover-McFarlane method

**Syntax**  
 $[K, CL, GAM, INFO] = ncfsyn(G)$   
 $[K, CL, GAM, INFO] = ncfsyn(G, W1)$   
 $[K, CL, GAM, INFO] = ncfsyn(G, W1, W2)$

**Description**  $ncfsyn$  is a method for designing controllers that uses a combination of loop shaping and robust stabilization as proposed in McFarlane and Glover [1]-[2]. The first step is for you to select a pre- and post-compensator  $W_1$  and  $W_2$ , so that the gain of the 'shaped plant'  $G_s := W_2 G W_1$  is sufficiently high at frequencies where good disturbance attenuation is required and is sufficiently low at frequencies where good robust stability is required. The second step is to use  $ncfsyn$  to compute an optimal *positive* feedback controllers  $K$ .

The optimal  $K_s$  has the property that the sigma plot of the shaped loop

$$L_s = W_2 * G * W_1 * K_s$$

matches the target loopshape  $G_s$  optimally, roughly to within plus or minus  $20 * \log_{10}(GAM)$  decibels. The number margin  $GAM = 1 / ncfmargin(G_s, K)$  and is always greater than 1.  $GAM$  gives a good indication of robustness of stability to a wide class of unstructured plant variations, with values in the range  $1 < GAM < 3$  corresponding to satisfactory stability margins for most typical control system designs.

**Algorithm**  $K = W_2 * K_s * W_1$ , where  $K_s = K_\infty$  is an optimal  $H_\infty$  controller that simultaneously minimizes the two  $H_\infty$  cost functions

$$\gamma := \min_K \left\| \begin{bmatrix} I \\ K \end{bmatrix} (I - G_s K)^{-1} \begin{bmatrix} G_s \\ I \end{bmatrix} \right\|_\infty$$

$$\gamma := \min_K \left\| \begin{bmatrix} I \\ G_s \end{bmatrix} (I - K G_s)^{-1} \begin{bmatrix} K \\ I \end{bmatrix} \right\|_\infty$$

Roughly speaking, this means for most plants that

$$\sigma(W_2 G W_1 K_\infty), db = \sigma(W_2 G W_1), db \pm \gamma, db$$

$$\sigma(K_\infty W_2 G W_1), db = \sigma(W_2 G W_1), db \pm \gamma, db,$$





GAM  $H_\infty$  optimal cost  $\gamma = \frac{1}{b(W_2GW_1, K_\infty)} = \text{hinfnorm}(CL) \geq 1$

INFO structure array containing additional information

Additional output INFO fields:

|           |                                                                           |
|-----------|---------------------------------------------------------------------------|
| INFO.emax | nugap robustness<br>emax=1/GAM=ncfmargin(Gs, -Ks)= $b(W_2GW_1, K_\infty)$ |
| INFO.Gs   | 'shaped plant' Gs=W2*G*W1                                                 |
| INFO.Ks   | Ks = $K_\infty = \text{NCFSYN}(Gs) = \text{NCFSYN}(W2*G*W1)$              |

[MARG, FREQ] = ncfmargin(G, K, TOL) calculates the normalized coprime factor/gap metric robust stability margin assuming *negative* feedback.

$$\text{MARG} = b(G, -K) = 1 / \left\| \begin{bmatrix} I \\ -K \end{bmatrix} (I + GK)^{-1} \begin{bmatrix} G & I \end{bmatrix} \right\|_\infty.$$

where G and K are LTI plant and controller, and TOL (default=.001) is the tolerance used to compute the  $H_\infty$  norm. FREQ is the peak frequency — i.e., the frequency at which the infinity norm is reached to within TOL.

## Algorithm

See the McFarlane and Glover [1]-[2] for details.

## Example

The following code shows how ncfsyn can be used for loop-shaping. The achieved loop G\*K has a sigma plot is equal to that of the target loop G\*W1 to within plus or minus  $20 \cdot \log_{10}(\text{GAM})$  decibels.

```
s=zpk('s');
G=(s-1)/(s+1)^2;
W1=0.5/s;
[K,CL,GAM]=ncfsyn(G,W1);
sigma(G*K,'r',G*W1,'r-',G*W1*GAM,'k-',G*W1/GAM,'k-')
```

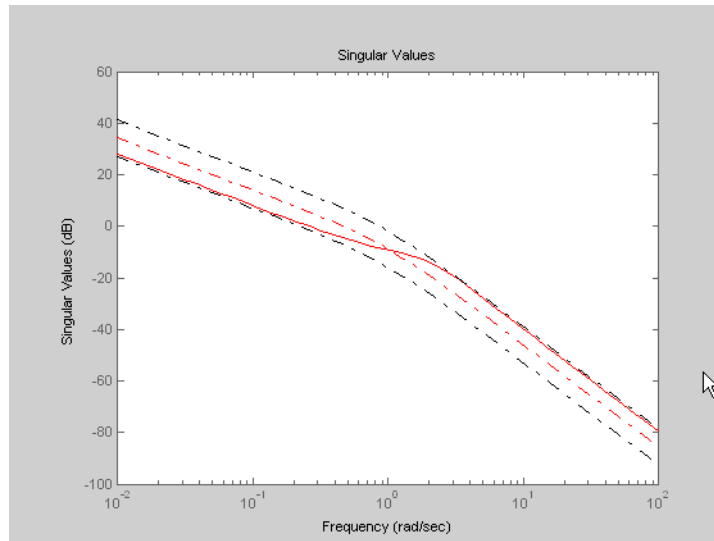

**Figure 10-15: Achieved loop  $G^*K$  and shaped loop  $G_s$ ,  $\pm 20\log(GAM)$  db**

## Reference

- [1] McFarlane, D. C., and K. Glover, Robust Controller Design using Normalised Coprime Factor Plant Descriptions, Springer Verlag, *Lecture Notes in Control and Information Sciences*, vol. 138, 1989.
- [2] McFarlane, D.C., and K. Glover, "A Loop Shaping Design Procedure using Synthesis," *IEEE Transactions on Automatic Control*, vol. 37, no. 6, pp. 759–769, June 1992.
- [3] Vinnicombe, G., "Measuring Robustness of Feedback Systems," PhD dissertation, Department of Engineering, University of Cambridge, 1993.
- [4] Zhou, K., and J. C. Doyle, Essentials of Robust Control. NY: Prentice-Hall, 1998.

## See Also

|           |                                                                           |
|-----------|---------------------------------------------------------------------------|
| gapmetric | Computes the gap and the Vinnicombe gap metric                            |
| hinfsyn   | $H_\infty$ controller synthesis                                           |
| loopsyn   | $H_\infty$ - loop shaping controller synthesis                            |
| ncfmargin | Normalized coprime stability margin of the plant-controller feedback loop |

# newlmi

---

**Purpose** Attach an identifying tag to LMIs

**Syntax** tag = newlmi

**Description** newlmi adds a new LMI to the LMI system currently described and returns an identifier tag for this LMI. This identifier can be used in lmiterm, showlmi, or dellmi commands to refer to the newly declared LMI. Tagging LMIs is *optional* and only meant to facilitate code development and readability.

Identifiers can be given mnemonic names to help keep track of the various LMIs. Their value is simply the ranking of each LMI in the system (in the order of declaration). They prove useful when some LMIs are deleted from the LMI system. In such cases, the identifiers are the safest means of referring to the remaining LMIs.

|                 |         |                                                          |
|-----------------|---------|----------------------------------------------------------|
| <b>See Also</b> | setlmis | Initialize the description of an LMI system              |
|                 | lmivar  | Specify the matrix variables in an LMI problem           |
|                 | lmiterm | Specify the term content of LMIs                         |
|                 | getlmis | Get the internal description of an LMI system            |
|                 | lmiedit | Specify or display systems of LMIs as MATLAB expressions |
|                 | dellmi  | Remove an LMI from a given system of LMIs                |

**Purpose** Convert the value for an atom in normalized coordinates to the corresponding actual value

**Syntax** `avalue = normalizedactual2(A,NV)`

**Description** `avalue = normalizedactual2(A,NV)` converts the value for atom in normalized coordinates, NV, to the corresponding actual value.

If NV is an array of values, then `avalue` will be an array of the same dimension.

**Example** Create uncertain real parameters with a range that is symmetric about the nominal value, where each end point is 1 unit from the nominal. Points that lie inside the range are less than 1 unit from the nominal, while points that lie outside the range are greater than 1 unit from the nominal.

```
a = ureal('a',3,'range',[1 5]);
actual2normalized(a,[1 3 5])
ans =
    -1.0000    -0.0000     1.0000
normalized2actual(a,[-1 1])
ans =
     1.0000     5.0000
normalized2actual(a,[-1.5 1.5])
ans =
     0.0000     6.0000
```

**See Also**

|                                |                                      |
|--------------------------------|--------------------------------------|
| <code>actual2normalized</code> | Calculates of an uncertain atom      |
| <code>robuststab</code>        | Calculates robust stability margin   |
| <code>robustperf</code>        | Calculates robust performance margin |

**Purpose** Assess the robust stability of a polytopic or parameter-dependent system

**Syntax** `[tau,Q0,Q1,...] = pd1stab(pds,options)`

**Description** `pd1stab` uses parameter-dependent Lyapunov functions to establish the stability of uncertain state-space models over some parameter range or polytope of systems. Only sufficient conditions for the existence of such Lyapunov functions are available in general. Nevertheless, the resulting robust stability tests are always less conservative than quadratic stability tests when the parameters are either time-invariant or slowly varying.

For an affine parameter-dependent system

$$\begin{aligned}E(p)\dot{x} &= A(p)x + B(p)u \\ y &= C(p)x + D(p)u\end{aligned}$$

with  $p = (p_1, \dots, p_n) \in \mathbf{R}^n$ , `pd1stab` seeks a Lyapunov function of the form

$$V(x, p) = x^T Q(p)^{-1} x, \quad Q(p) = Q_0 + p_1 Q_1 + \dots + p_n Q_n$$

such that  $dV(x, p)/dt < 0$  along all admissible parameter trajectories. The system description `pds` is specified with `psys` and contains information about the range of values and rate of variation of each parameter  $p_i$ .

For a *time-invariant* polytopic system

$$\begin{aligned}E\dot{x} &= Ax + Bu \\ y &= Cx + Du\end{aligned}$$

with

$$\begin{pmatrix} A + jE & B \\ C & D \end{pmatrix} = \sum_{i=1}^n \alpha_i \begin{pmatrix} A + jE_i & B_i \\ C_i & D_i \end{pmatrix}, \quad \alpha_i \geq 0, \quad \sum_{i=1}^n \alpha_i = 1, \quad (10-19)$$

`pd1stab` seeks a Lyapunov function of the form

$$V(x, \alpha) = x^T Q(\alpha)^{-1} x, \quad Q(\alpha) = \alpha_1 Q_1 + \dots + \alpha_n Q_n$$

such that  $dV(x, \alpha)/dt < 0$  for all polytopic decompositions (9-19).

Several options and control parameters are accessible through the optional argument options:

- Setting options(1)=0 tests robust stability (default)
- When options(2)=0, pd1stab uses simplified sufficient conditions for faster running times. Set options(2)=1 to use the least conservative conditions

**Remark**

For affine parameter-dependent systems with *time-invariant* parameters, there is equivalence between the robust stability of

$$E(p)\dot{x} = A(p)x \tag{10-20}$$

and that of the dual system

$$E(p)^T \dot{z} = A(p)^T z \tag{10-21}$$

However, the second system may admit an affine parameter-dependent Lyapunov function while the first does not.

In such case, pd1stab automatically restarts and tests stability on the dual system (9-21) when it fails on (9-20).

**See Also**

quadstab                      Quadratic stability of polytopic or affine parameter-dependent systems

# pdsimul

---

**Purpose** Time response of a parameter-dependent system along a given parameter trajectory

**Syntax**  
`pdsimul(pds,'traj',tf,'ut',xi,options)`  
`[t,x,y] = pdsimul(pds,pv,'traj',tf,'ut',xi,options)`

**Description** pdsimul simulates the time response of an affine parameter-dependent system

$$E(p)x = A(p)x + B(p)u$$
$$y = C(p)x + D(p)u$$

along a parameter trajectory  $p(t)$  and for an input signal  $u(t)$ . The parameter trajectory and input signals are specified by two time functions  $p=\text{traj}(t)$  and  $u=\text{ut}(t)$ . If 'ut' is omitted, the response to a step input is computed by default.

The affine system pds is specified with psys. The function pdsimul also accepts the polytopic representation of such systems as returned by `aff2pol(pds)` or `hinfgs`. The final time and initial state vector can be reset through `tf` and `xi` (their respective default values are 5 seconds and 0). Finally, `options` gives access to the parameters controlling the ODE integration (type `help gear` for details).

When invoked without output arguments, pdsimul plots the output trajectories  $y(t)$ . Otherwise, it returns the vector of integration time points `t` as well as the state and output trajectories `x`, `y`.

**See Also**

|                   |                                                      |
|-------------------|------------------------------------------------------|
| <code>psys</code> | Specification of uncertain state-space models        |
| <code>pvec</code> | Quantification of uncertainty on physical parameters |



**Purpose** Compute polytopic coordinates wrt. box corners

**Syntax**  
`vertx = polydec(PV)`  
`[C,vertx] = polydec(PV,P)`

**Description** `vertx = polydec(PV)` takes an uncertain parameter vector `PV` taking values ranging in a box, and returns the corners or vertices of the box as columns of the matrix `vertx`.

`[C,vertx] = polydec(PV,P)` takes an uncertain parameter vector `PV` and a value `P` of the parameter vector `PV`, and returns the convex decomposition `C` of `P` over the set `VERTX` of box corners:

$$P = c_1 \cdot \text{VERTX}(:,1) + \dots + c_n \cdot \text{VERTX}(:,n)$$

$$c_j \geq 0, \quad c_1 + \dots + c_n = 1$$

The list `vertx` of corners can be obtained directly by typing

```
vertx = polydec(PV)
```

**See Also**

|                      |                                                              |
|----------------------|--------------------------------------------------------------|
| <code>pvec</code>    | Quantification of uncertainty on physical parameters         |
| <code>pvinfos</code> | Describe a parameter vector specified with <code>pvec</code> |
| <code>aff2pol</code> | Convert affine parameter-dependent models to polytopic ones  |
| <code>hifgs</code>   | Synthesis of gain-scheduled $H_\infty$ controllers           |

# popov

---

**Purpose** Perform the Popov robust stability test

**Syntax** `[t,P,S,N] = popov(sys,delta,flag)`

**Description** popov uses the Popov criterion to test the robust stability of dynamical systems with possibly nonlinear and/or time-varying uncertainty. The uncertain system must be described as the interconnection of a nominal LTI system sys and some uncertainty delta.

The command

```
[t,P,S,N] = popov(sys,delta)
```

tests the robust stability of this interconnection. Robust stability is guaranteed if  $t < 0$ . Then P determines the quadratic part  $x^T P x$  of the Lyapunov function and D and S are the Popov multipliers.

If the uncertainty delta contains real parameter blocks, the conservatism of the Popov criterion can be reduced by first performing a simple loop transformation. To use this refined test, call popov with the syntax

```
[t,P,S,N] = popov(sys,delta,1)
```

**See Also**

|          |                                                                                |
|----------|--------------------------------------------------------------------------------|
| quadstab | Quadratic stability of polytopic or affine parameter-dependent systems         |
| pdlstab  | Robust stability of polytopic or affine parameter-dependent systems (P-system) |

**Purpose** Inquire about polytopic or parameter-dependent systems created with psys

**Syntax**

```
psinfo(ps)
[type,k,ns,ni,no] = psinfo(ps)
pv = psinfo(ps,'par')
sk = psinfo(ps,'sys',k)
sys = psinfo(ps,'eval',p)
```

**Description** psinfo is a multi-usage function for queries about a polytopic or parameter-dependent system ps created with psys. It performs the following operations depending on the calling sequence:

- psinfo(ps) displays the type of system (affine or polytopic); the number k of SYSTEM matrices involved in its definition; and the numbers of ns, ni, no of states, inputs, and outputs of the system. This information can be optionally stored in MATLAB variables by providing output arguments.
- pv = psinfo(ps,'par') returns the parameter vector description (for parameter-dependent systems only).
- sk = psinfo(ps,'sys',k) returns the k-th SYSTEM matrix involved in the definition of ps. The ranking k is relative to the list of systems syslist used in psys.
- sys = psinfo(ps,'eval',p) instantiates the system for a given vector p of parameter values or polytopic coordinates.

For *affine parameter-dependent* systems defined by the SYSTEM matrices  $S_0, S_1, \dots, S_n$ , the entries of p should be real parameter values  $p_1, \dots, p_n$  and the result is the LTI system of SYSTEM matrix

$$S(p) = S_0 + p_1 S_1 + \dots + p_n S_n$$

For *polytopic* systems with SYSTEM matrix ranging in

$$\text{Co}\{S_1, \dots, S_n\},$$

the entries of p should be polytopic coordinates  $p_1, \dots, p_n$  satisfying  $p_j \in [0, 1]$  and the result is the interpolated LTI system of SYSTEM matrix

$$S = \frac{p_1 S_1 + \dots + p_n S_n}{p_1 + \dots + p_n}$$

**See Also** psys Specification of uncertain state-space models

**Purpose** Specify polytopic or parameter-dependent linear systems

**Syntax**  
`pols = psys(syslist)`  
`affs = psys(pv, syslist)`

**Description** `psys` specifies state-space models where the state-space matrices can be uncertain, time-varying, or parameter-dependent.

Two types of uncertain state-space models can be manipulated in the LMI Control Toolbox:

- *Polytopic systems*

$$E(t)\dot{x} = A(t)x + B(t)u$$

$$y = C(t)x + D(t)u$$

whose SYSTEM matrix takes values in a fixed polytope:

$$\underbrace{\begin{bmatrix} A(t) + jE(t) & B(t) \\ C(t) & D(t) \end{bmatrix}}_{S(t)} \in \text{Co} \left\{ \underbrace{\begin{bmatrix} A_1 + jE_1 & B_1 \\ C_1 & D_1 \end{bmatrix}}_{S_1}, \dots, \underbrace{\begin{bmatrix} A_k + jE_k & B_k \\ C_k & D_k \end{bmatrix}}_{S_k} \right\}$$

where  $S_1, \dots, S_k$  are given “vertex” systems and

$$\text{Co}\{S_1, \dots, S_k\} = \left\{ \sum_{i=1}^k \alpha_i S_i : \alpha_i \geq 0, \sum_{i=1}^k \alpha_i = 1 \right\}$$

denotes the convex hull of  $S_1, \dots, S_k$  (polytope of matrices with vertices  $S_1, \dots, S_k$ )

- *Affine parameter-dependent systems*

$$E(p)\dot{x} = A(p)x + B(p)u$$

$$y = C(p)x + D(p)u$$

where  $A(\cdot); B(\cdot), \dots, E(\cdot)$  are fixed affine functions of some vector  $p = (p_1, \dots, p_n)$  of real parameters, i.e.,

$$\underbrace{\begin{bmatrix} A(p) + jE(p) & B(p) \\ C(p) & D(p) \end{bmatrix}}_{S(p)} = \underbrace{\begin{bmatrix} A_0 + jE_0 & B_0 \\ C_0 & D_0 \end{bmatrix}}_{S_0} + p_1 \underbrace{\begin{bmatrix} A_1 + jE_1 & B_1 \\ C_1 & D_1 \end{bmatrix}}_{S_1} + \dots + p_n \underbrace{\begin{bmatrix} A_n + jE_n & B_n \\ C_n & D_n \end{bmatrix}}_{S_n}$$

where  $S_0, S_1, \dots, S_n$  are given SYSTEM matrices. The parameters  $p_i$  can be time-varying or constant but uncertain.

Both types of models are specified with the function `psys`. The argument `syslist` lists the SYSTEM matrices  $S_i$  characterizing the polytopic value set or parameter dependence. In addition, the description `pv` of the parameter vector (range of values and rate of variation) is required for affine parameter-dependent models (see `pvec` for details). Thus, a polytopic model with vertex systems  $S_1, \dots, S_4$  is created by

```
polS = psys([s1,s2,s3,s4])
```

while an affine parameter-dependent model with 4 real parameters is defined by

```
affS = psys(pv,[s0,s1,s2,s3,s4])
```

The output is a structured matrix storing all the relevant information.

**See Also**

- `psinfo`                    Inquire about polytopic or parameter-dependent systems created with `psys`
- `pvec`                     Quantification of uncertainty on physical parameters
- `aff2pol`                 Convert affine parameter-dependent models to polytopic ones

**Purpose** Specify the range and rate of variation of uncertain or time-varying parameters

**Syntax**

```
pv = pvec('box', range, rates)
pv = pvec('pol', vertices)
```

**Description** pvec is used in conjunction with psys to specify parameter-dependent systems. Such systems are parametrized by a vector  $p = (p_1, \dots, p_n)$  of uncertain or time-varying real parameters  $p_i$ . The function pvec defines the range of values and the rates of variation of these parameters.

The type 'box' corresponds to independent parameters ranging in intervals

$$\underline{p}_j \leq p_j \leq \bar{p}_j$$

The parameter vector  $p$  then takes values in a hyperrectangle of  $\mathbf{R}^n$  called the parameter box. The second argument range is an  $n$ -by-2 matrix that stacks up the extremal values  $\underline{p}_j$  and  $\bar{p}_j$  of each  $p_j$ . If the third argument rates is omitted, all parameters are assumed time-invariant. Otherwise, rates is also an  $n$ -by-2 matrix and its  $j$ -th row specifies lower and upper bounds  $\underline{v}_j$  and  $\bar{v}_j$  on  $\frac{dp_j}{dt}$ :

$$\underline{v}_j \leq \frac{dp_j}{dt} \leq \bar{v}_j$$

Set  $\underline{v}_j = \text{Inf}$  and  $\bar{v}_j = \text{Inf}$  if  $p_j(t)$  can vary arbitrarily fast or discontinuously.

The type 'pol' corresponds to parameter vectors  $p$  ranging in a polytope of the parameter space  $\mathbf{R}^n$ . This polytope is defined by a set of vertices  $V_1, \dots, V_n$  corresponding to "extremal" values of the vector  $p$ . Such parameter vectors are declared by the command

```
pv = pvec('pol', [v1, v2, . . . , vn])
```

where the second argument is the concatenation of the vectors  $v_1, \dots, v_n$ .

The output argument pv is a structured matrix storing the parameter vector description. Use pvinfos to read the contents of pv.

**Example** Consider a problem with two time-invariant parameters

$$p_1 \in [-1, 2], \quad p_2 \in [20, 50]$$

The corresponding parameter vector  $p = (p_1, p_2)$  is specified by

```
pv = pvec('box', [-1 2; 20 50])
```

Alternatively, this vector can be regarded as taking values in the rectangle drawn in Figure 9.2. The four corners of this rectangle are the four vectors

$$v_1 = \begin{pmatrix} -1 \\ 20 \end{pmatrix}, \quad v_2 = \begin{pmatrix} -1 \\ 50 \end{pmatrix}, \quad v_3 = \begin{pmatrix} 2 \\ 20 \end{pmatrix}, \quad v_4 = \begin{pmatrix} 2 \\ 50 \end{pmatrix}$$

Hence, you could also specify  $p$  by

```
pv = pvec('pol', [v1, v2, v3, v4])
```

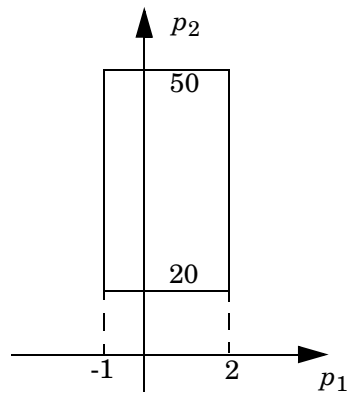

**Figure 10-16: Parameter box**

### See Also

pvinfos  
psys

Describe a parameter vector specified with pvec  
Specification of uncertain state-space models

# pvinfos

---

**Purpose** Describe a parameter vector specified with pvec

**Syntax**

```
[typ,k,nv] = pvinfos(pv)
[pmin,pmax,dpmin,dpmax] = pvinfos(pv,'par',j)
vj = pvinfos(pv,'par',j)
p = pvinfos(pv,'eval',c)
```

**Description** pvec retrieves information about a vector  $p = (p_1, \dots, p_n)$  of real parameters declared with pvec and stored in pv. The command pvinfos(pv) displays the type of parameter vector ('box' or 'pol'), the number  $n$  of scalar parameters, and for the type 'pol', the number of vertices used to specify the parameter range.

For the type 'box':

```
[pmin,pmax,dpmin,dpmax] = pvinfos(pv,'par',j)
```

returns the bounds on the value and rate of variations of the  $j$ -th real parameter  $p_j$ . Specifically,

$$p_{\min} \leq p_j(t) \leq p_{\max}, \quad dp_{\min} \leq \frac{dp_j}{dt} \leq dp_{\max}$$

For the type 'pol':

```
pvinfos(pv,'par',j)
```

returns the  $j$ -th vertex of the polytope of  $\mathbf{R}^n$  in which  $p$  ranges, while

```
pvinfos(pv,'eval',c)
```

returns the value of the parameter vector  $p$  given its barycentric coordinates  $c$  with respect to the polytope vertices  $(V_1, \dots, V_k)$ . The vector  $c$  must be of length  $k$  and have nonnegative entries. The corresponding value of  $p$  is then given by

$$p = \frac{\sum_{i=1}^k c_i V_i}{\sum_{i=1}^k c_i}$$

**See Also**

|      |                                                      |
|------|------------------------------------------------------|
| pvec | Quantification of uncertainty on physical parameters |
| psys | Specification of uncertain state-space models        |



**Purpose** Compute the quadratic  $H_\infty$  performance of a polytopic or parameter-dependent system

**Syntax** `[perf,P] = quadperf(ps,g,options)`

**Description** The RMS gain of the time-varying system

$$E(t)\dot{x} = A(t)x + B(t)u, \quad y = C(t)x + D(t)u \quad (10-22)$$

is the smallest  $\gamma > 0$  such that

$$\|y\|_{L_2} \leq \gamma \|u\|_{L_2} \quad (10-23)$$

for all input  $u(t)$  with bounded energy. A sufficient condition for (9-23) is the existence of a quadratic Lyapunov function

$$V(x) = x^T P x, \quad P > 0$$

such that

$$\forall u \in L_2, \quad \frac{dV}{dt} + y^T y - \gamma^2 u^T u < 0$$

Minimizing  $\gamma$  over such quadratic Lyapunov functions yields the quadratic  $H_\infty$  performance, an upper bound on the true RMS gain.

The command

$$[\text{perf}, P] = \text{quadperf}(ps)$$

computes the quadratic  $H_\infty$  performance `perf` when (9-22) is a polytopic or affine parameter-dependent system `ps` (see `psys`). The Lyapunov matrix  $P$  yielding the performance `perf` is returned in `P`.

The optional input `options` gives access to the following task and control parameters:

- If `options(1)=1`, `perf` is the largest portion of the parameter box where the quadratic RMS gain remains smaller than the positive value `g` (for affine parameter-dependent systems only). The default value is 0

# quadperf

---

- If `options(2)=1`, `quadperf` uses the least conservative quadratic performance test. The default is `options(2)=0` (fast mode)
- `options(3)` is a user-specified upper bound on the condition number of  $P$  (the default is  $10^9$ ).

## See Also

|                       |                                                                        |
|-----------------------|------------------------------------------------------------------------|
| <code>quadstab</code> | Quadratic stability of polytopic or affine parameter-dependent systems |
| <code>psys</code>     | Specification of uncertain state-space models                          |

**Purpose** Quadratic stability of polytopic or affine parameter-dependent systems

**Syntax** `[tau,P] = quadstab(ps,options)`

**Description** For affine parameter-dependent systems

$$E(p)x = A(p)x, \quad p(t) = (p_1(t), \dots, p_n(t))$$

or polytopic systems

$$E(t)x = A(t)x, \quad (A, E) \in \text{Co}\{(A_1, E_1), \dots, (A_n, E_n)\},$$

quadstab seeks a fixed Lyapunov function  $V(x) = x^T P x$  with  $P > 0$  that establishes quadratic stability. The affine or polytopic model is described by ps (see psys).

The task performed by quadstab is selected by options(1):

- if options(1)=0 (default), quadstab assesses quadratic stability by solving the LMI problem

Minimize  $\tau$  over  $Q = Q^T$  such that

$$A^T Q E + E Q A^T < \tau I \text{ for all admissible values of } (A, E)$$

$$Q > I$$

The global minimum of this problem is returned in tau and the system is quadratically stable if tau < 0

- if options(1)=1, quadstab computes the largest portion of the specified parameter range where quadratic stability holds (only available for affine models). Specifically, if each parameter  $p_i$  varies in the interval

$$p_i \in [p_{i0} - \delta_i, p_{i0} + \delta_i],$$

quadstab computes the largest  $\theta > 0$  such that quadratic stability holds over the parameter box

$$p_i \in [p_{i0} - \theta \delta_i, p_{i0} + \theta \delta_i]$$

This “quadratic stability margin” is returned in tau and ps is quadratically stable if tau  $\geq$  1.

Given the solution  $Q_{\text{opt}}$  of the LMI optimization, the Lyapunov matrix  $P$  is given by  $P = Q_{\text{opt}}^{-1}$ . This matrix is returned in P.

# quadstab

---

Other control parameters can be accessed through `options(2)` and `options(3)`:

- if `options(2)=0` (default), `quadstab` runs in fast mode, using the least expensive sufficient conditions. Set `options(2)=1` to use the least conservative conditions
- `options(3)` is a bound on the condition number of the Lyapunov matrix  $P$ . The default is  $10^9$ .

## See Also

|                       |                                                                                           |
|-----------------------|-------------------------------------------------------------------------------------------|
| <code>pd1stab</code>  | Robust stability of polytopic or affine parameter-dependent systems (P-system)            |
| <code>decay</code>    | Quadratic decay rate of polytopic or affine P-systems                                     |
| <code>quadperf</code> | Compute the quadratic $H_\infty$ performance of a polytopic or parameter-dependent system |
| <code>psys</code>     | Specification of uncertain state-space models                                             |

|                       |                                                                                                                                                                                                                                                                                                                                                                                                                                                                                                                                                                                                                                                                                                                                                                                                                                                                                                                                                        |                   |                                                |                    |                                               |                       |                                   |
|-----------------------|--------------------------------------------------------------------------------------------------------------------------------------------------------------------------------------------------------------------------------------------------------------------------------------------------------------------------------------------------------------------------------------------------------------------------------------------------------------------------------------------------------------------------------------------------------------------------------------------------------------------------------------------------------------------------------------------------------------------------------------------------------------------------------------------------------------------------------------------------------------------------------------------------------------------------------------------------------|-------------------|------------------------------------------------|--------------------|-----------------------------------------------|-----------------------|-----------------------------------|
| <b>Purpose</b>        | Generate random uncertain atom objects                                                                                                                                                                                                                                                                                                                                                                                                                                                                                                                                                                                                                                                                                                                                                                                                                                                                                                                 |                   |                                                |                    |                                               |                       |                                   |
| <b>Syntax</b>         | <pre>A = randatom(Type) A = randatom(Type,sz) A = randatom</pre>                                                                                                                                                                                                                                                                                                                                                                                                                                                                                                                                                                                                                                                                                                                                                                                                                                                                                       |                   |                                                |                    |                                               |                       |                                   |
| <b>Description</b>    | <p><code>A = randatom(Type)</code> generates a 1-by-1 type uncertain object. Valid values for <code>Type</code> include 'ureal', 'ultidyn', 'ucomplex', and 'ucomplexm'.</p> <p><code>A = randatom(Type,sz)</code> generates an <code>sz(1)</code>-by-<code>sz(2)</code> uncertain object. Valid values for <code>Type</code> include 'ultidyn' or 'ucomplexm'. If <code>Type</code> is set to 'ureal' or 'ucomplex', the size variable is ignored and <code>A</code> is a 1-by-1 uncertain object.</p> <p><code>A = randatom</code>, where <code>randatom</code> has no input arguments, results in a 1-by-1 uncertain object. The class of this object is randomly selected between 'ureal', 'ultidyn' and 'ucomplex'.</p> <p>In general, both <code>rand</code> and <code>randn</code> are used internally. You can control the result of <code>randatom</code> by setting seeds for both random number generators before calling the function.</p> |                   |                                                |                    |                                               |                       |                                   |
| <b>Example</b>        | <p>The following statement creates the ureal uncertain object <code>xr</code>. Note that your display may differ because a random seed is used.</p> <pre>xr = randatom('ureal') Uncertain Real Parameter: Name BMSJA, NominalValue -6.75, Range [-7.70893 -1.89278]</pre> <p>The following statement creates the variable ultidyn uncertain object <code>xlti</code> with three inputs and four outputs. You will get the results shown below if both the random variable seeds are set to 29.</p> <pre>rand(`seed`,29); randn(`seed`,29); xlti = randatom('ultidyn',[4 3]) Uncertain GainBounded LTI Dynamics: Name 00JGS, 4x3, Gain Bound = 0.646</pre>                                                                                                                                                                                                                                                                                              |                   |                                                |                    |                                               |                       |                                   |
| <b>See Also</b>       | <table border="0"> <tr> <td><code>rand</code></td> <td>Generates uniformly distributed random numbers</td> </tr> <tr> <td><code>randn</code></td> <td>Generates normally distributed random numbers</td> </tr> <tr> <td><code>randumat</code></td> <td>Creates a random uncertain matrix</td> </tr> </table>                                                                                                                                                                                                                                                                                                                                                                                                                                                                                                                                                                                                                                           | <code>rand</code> | Generates uniformly distributed random numbers | <code>randn</code> | Generates normally distributed random numbers | <code>randumat</code> | Creates a random uncertain matrix |
| <code>rand</code>     | Generates uniformly distributed random numbers                                                                                                                                                                                                                                                                                                                                                                                                                                                                                                                                                                                                                                                                                                                                                                                                                                                                                                         |                   |                                                |                    |                                               |                       |                                   |
| <code>randn</code>    | Generates normally distributed random numbers                                                                                                                                                                                                                                                                                                                                                                                                                                                                                                                                                                                                                                                                                                                                                                                                                                                                                                          |                   |                                                |                    |                                               |                       |                                   |
| <code>randumat</code> | Creates a random uncertain matrix                                                                                                                                                                                                                                                                                                                                                                                                                                                                                                                                                                                                                                                                                                                                                                                                                                                                                                                      |                   |                                                |                    |                                               |                       |                                   |

# randatom

---

|           |                                                   |
|-----------|---------------------------------------------------|
| randuss   | Creates a random uncertain system                 |
| ucomplex  | Creates an uncertain complex parameter            |
| ucomplexm | Creates an uncertain complex matrix               |
| ultidyn   | Creates an uncertain linear time-invariant object |

**Purpose** Generate random uncertain umat objects

**Syntax**  
`um = randumat(ny,nu)`  
`um = randumat`

**Description**  
`um = randumat(ny,nu)` generates an uncertain matrix of size ny-by-nu. `randumat` randomly selects from uncertain atoms of type 'ureal', 'ultidyn', and 'ucomplex'.

`um = randumat` results in a 1-by-1 umat uncertain object, including up to four uncertain objects.

**Example**  
 The following statement creates the umat uncertain object x1 of size 2-by-3. Note that your result may differ because a random seed is used.

```
x1 = randumat(2,3)
UMAT: 2 Rows, 3 Columns
  ROQAW: complex, nominal = 9.92+4.84i, radius = 0.568, 1
  occurrence
  UEPDY: real, nominal = -5.81, variability = [-1.98681
  0.133993], 3 occurrences
  VVNHL: complex, nominal = 5.64-6.13i, radius = 1.99, 2
  occurrences
```

The following statement creates the umat uncertain object x2 of size 4-by-2 with the seed 91.

```
rand(`seed',91); randn(`seed',91);
x2 = randumat(4,2)
UMAT: 4 Rows, 2 Columns
  SSAFF: complex, nominal = -0.366+2.81i, radius = 1.76, 3
  occurrences
  VDTIH: complex, nominal = -3.03-3i, +/- 27.5%, 2 occurrences
  XOLLJ: real, nominal = 0.0628, range = [-3.73202 4.28174], 1
  occurrence
```

**See Also**

|                       |                                               |
|-----------------------|-----------------------------------------------|
| <code>rand</code>     | Generate uniformly distributed random numbers |
| <code>randn</code>    | Generate normally distributed random numbers  |
| <code>randatom</code> | Create a random uncertain atom                |
| <code>randuss</code>  | Create a random uncertain system              |
| <code>ucomplex</code> | Creates an uncertain complex parameter        |

# randumat

---

ultidyn

Creates an uncertain linear time-invariant object



**Purpose** Generates stable, random uss objects.

**Syntax**

```
usys = randuss(n)
usys = randuss(n,p)
usys = randuss(n,p,m)
usys = randuss(n,p,m,Ts)
usys = randuss
```

**Description** `usys = randuss(n)` generates an n-th order single-input/single-output uncertain continuous-time system. **randuss** randomly selects from uncertain atoms of type 'ureal', 'ultidyn', and 'ucomplex'.

`usys = randuss(n,p)` generates an n-th order single-input uncertain continuous-time system with `p` outputs.

`usys = randuss(n,p,m)` generates an n-th order uncertain continuous-time system with `p` outputs and `m` inputs.

`usys = randuss(n,p,m,Ts)` generates an n-th order uncertain discrete-time system with `p` outputs and `m` inputs. The sample time is `Ts`.

`usys = randuss` (without arguments) results in a 1-by-1 uncertain continuous-time uss object with up to four uncertain objects.

In general, both `rand` and `randn` are used internally. You can control the result of `randuss` by setting seeds for both random number generators before calling the function.

**Example** The statement creates a 5th order, continuous-time uncertain system, `s1`, of size 2-by-3. Note your display may differ since a random seed is used.

```
s1 = randuss(5,2,3)
USS: 5 States, 2 Outputs, 3 Inputs, Continuous System
CTPQV: 1x1 LTI, max. gain = 2.2, 1 occurrence
IGDHN: real, nominal = -4.03, variability = [-3.74667
22.7816]%, 1 occurrence
MLGCD: complex, nominal = 8.36+3.09i, +/- 7.07%, 1 occurrence
OEDJK: complex, nominal = -0.346-0.296i, radius = 0.895, 1
occurrence
```

**See Also** `rand` Generates uniformly distributed random numbers

# randuss

---

|          |                                                   |
|----------|---------------------------------------------------|
| randn    | Generates normally distributed random numbers     |
| randatom | Creates a random uncertain atom                   |
| randumat | Creates a random uncertain matrix                 |
| ucomplex | Creates an uncertain complex parameter            |
| ultidyn  | Creates an uncertain linear time-invariant object |

**Purpose** LAPACK reciprocal condition estimator of a frd object.

**Syntax** `r = rcond(x)`

**Description** `rcond(x)` is an estimate for the reciprocal of the condition of the frd object `x` in the 1-norm obtained by the LAPACK condition estimator. `rcond` operates on `x.ReponseData` of the `x` frd at each frequency to construct `r`. If `x` is well conditioned, `rcond(x)` is near 1.0. If `x` is badly conditioned, `rcond(x)` is near EPS.

`r=rcond(x)` returns `r` as an frd object.

**See Also**

|                      |                                                       |
|----------------------|-------------------------------------------------------|
| <code>cond</code>    | Calculates condition number with respect to inversion |
| <code>norm</code>    | Calculates matrix or vector norm                      |
| <code>condest</code> | Calculates a 1-norm condition number estimate         |
| <code>normest</code> | Calculates a matrix 2-norm estimate                   |

# reduce

**Purpose** Simplified access to Hankel singular value based model reduction functions

**Syntax**

```
GRED = reduce(G)
GRED = reduce(G,order)
[GRED,redinfo] = reduce(G,'key1','value1',...)
[GRED,redinfo] = reduce(G,order,'key1','value1',...)
```

**Description** reduce returns a reduced order model GRED of G and a struct array redinfo containing the error bound of the reduced model, Hankel singular values of the original system and some other relevant model reduction information.

An error bound is a measure of how close GRED is to G and is computed based on either *additive error*,  $\|G - GRED\|_{\infty}$ , *multiplicative error*,  $\|G^{-1}(G - GRED)\|_{\infty}$ , or *nugap error* (ref.: ncfmr) [1],[4],[5].

Hankel singular values of a stable system indicate the respective state energy of the system. Hence, reduced order can be directly determined by examining the system Hankel SV's. Model reduction routines, which based on Hankel SV's are grouped by their error bound types. In many cases, the additive error method  $GRED = \text{reduce}(G, ORDER)$  is adequate to provide a good reduced order model. But for systems with lightly damped poles and/or zeros, a multiplicative error method (namely,  $GRED = \text{reduce}(G, ORDER, 'ErrorType', 'mult')$ ) that minimizes the relative error between G and GRED tends to produce a better fit.

This table describes input arguments for reduce.

| Argument | Description                                                                                                                         |
|----------|-------------------------------------------------------------------------------------------------------------------------------------|
| G        | LTI model to be reduced (without any other inputs will plot its Hankel singular values and prompt for reduced order).               |
| ORDER    | (Optional) an integer for the desired order of the reduced model, or optionally a vector packed with desired orders for batch runs. |

A batch run of a serial of different reduced order models can be generated by specifying `order = x:y`, or a vector of integers. By default, all the anti-stable part of a physical system is kept, because from control stability point of view, getting rid of unstable state(s) is dangerous to model a system.

'MaxError' can be specified in the same fashion as an alternative for 'ORDER' after an 'ErrorType' is selected. In this case, reduced order will be determined when the sum of the tails of the Hankel SV's reaches the 'MaxError'.

| Argument    | Value                                                  | Description                                                                                                                                                               |
|-------------|--------------------------------------------------------|---------------------------------------------------------------------------------------------------------------------------------------------------------------------------|
| 'Algorithm' | 'balance'<br>'schur'<br>'hankel'<br>'bst'<br>'ncf'     | Default for 'add' (balancmr)<br>Option for 'add' (schurmr)<br>Option for 'add' (hankelmr)<br>Default for 'mult' (bstmr)<br>Default for 'ncf' (ncfmr)                      |
| 'ErrorType' | 'add'<br>'mult'<br>'ncf'                               | Additive error (default)<br>Multiplicative error at model output<br>NCF nugap error                                                                                       |
| 'MaxError'  | A real number<br>or a vector of<br>different<br>errors | Reduce to achieve $H_\infty$ error.<br>When present, 'MaxError' overrides<br>ORDER input.                                                                                 |
| 'Weights'   | {Wout,Win}<br>cell array                               | Optimal 1x2 cell array of LTI weights<br>Wout (output) and Win (input); default is<br>both identity; used only with<br>'ErrorType', 'add'. Weights must be<br>invertible. |
| 'Display'   | 'on' or 'off'                                          | Display Hankel singular plots (default<br>'off').                                                                                                                         |
| 'Order'     | Integer, vector<br>or cell array                       | Order of reduced model. Use only if not<br>specified as 2nd argument.                                                                                                     |

Weights on the original model input and/or output can make the model reduction algorithm focus on some frequency range of interests. But weights have to be stable, minimum phase and invertible.

# reduce

This table describes output arguments.

| Argument | Description                                                                                                                                                                                                                                                                                                                                                                                                                                                                                                 |
|----------|-------------------------------------------------------------------------------------------------------------------------------------------------------------------------------------------------------------------------------------------------------------------------------------------------------------------------------------------------------------------------------------------------------------------------------------------------------------------------------------------------------------|
| GRED     | LTI reduced order model. Becomes multi-dimensional array when input is a serial of different model order array.                                                                                                                                                                                                                                                                                                                                                                                             |
| REDINFO  | A STRUCT array with 3 fields: <ul style="list-style-type: none"><li>• REDINFO.ErrorBound</li><li>• REDINFO.StabSV</li><li>• REDINFO.UnstabSV</li></ul> For 'hanke1' algorithm, STRUCT array becomes: <ul style="list-style-type: none"><li>• REDINFO.ErrorBound</li><li>• REDINFO.StabSV</li><li>• REDINFO.UnstabSV</li><li>• REDINFO.Ganticausal</li></ul> For 'ncf' option, STRUCT array becomes: <ul style="list-style-type: none"><li>• REDINFO.GL</li><li>• REDINFO.GR</li><li>• REDINFO.hsv</li></ul> |

G can be stable or unstable. G and GRED can be either continuous or discrete.

A successful model reduction with a well-conditioned original model G will ensure that the reduced model GRED satisfies the infinity norm error bound.

## Example

Given a continuous or discrete, stable or unstable system, G, the following commands can get a set of reduced order models based on your selections:

```
rand('state',1234); randn('state',5678); G = rss(30,5,4);
[g1, redinfo1] = reduce(G); % display Hankel SV plot
                    % and prompt for order
[g2, redinfo2] = reduce(G,20); % default to balancmr
[g3, redinfo3] = reduce(G,[10:2:18],'algorithm','schur');
                    % select schurmr
[g4, redinfo] = reduce(G,'ErrorType','mult','MaxError',[0.01,
0.05]);
```

```

rand('state',12345); randn('state',6789);
wt1 = rss(6,5,5); wt1.d = eye(5)*2;
wt2 = rss(6,4,4); wt2.d = 2*eye(4);
[g5, redinfo5] = reduce(G, [10:2:18], 'weight',{wt1,wt2});
[g6, redinfo6] =
reduce(G, 'ErrorType', 'add', 'algorithm', 'hankel', ...
      'maxerror',[0.01]);
for i = 1:6
    figure(i); eval(['sigma(G,g' num2str(i) ');']);
end

```

## Reference

- [1] K. Glover, "All Optimal Hankel Norm Approximation of Linear Multivariable Systems, and Their  $L_\infty$  - error Bounds," *Int. J. Control*, vol. 39, no. 6, pp. 1145-1193, 1984.
- [2] M. G. Safonov and R. Y. Chiang, "A Schur Method for Balanced Model Reduction," *IEEE Trans. on Automat. Contr.*, vol. AC-2, no. 7, July 1989, pp. 729-733.
- [3] M. G. Safonov, R. Y. Chiang and D. J. N. Limebeer, "Optimal Hankel Model Reduction for Nonminimal Systems," *IEEE Trans. on Automat. Contr.*, vol. 35, No. 4, April, 1990, pp. 496-502.
- [4] M. G. Safonov and R. Y. Chiang, "Model Reduction for Robust Control: A Schur Relative-Error Method," *International Journal of Adaptive Control and Signal Processing*, vol. 2, pp. 259-272, 1988.
- [5] K. Zhou, "Frequency weighted  $L_2$  error bounds," *Syst. Contr. Lett.*, Vol. 21, 115-125, 1993.

## See Also

|          |                                                    |
|----------|----------------------------------------------------|
| balancmr | Balanced truncation via square-root method         |
| schurmr  | Balanced truncation via Schur method               |
| bstmr    | Balanced stochastic truncation via Schur method    |
| ncfmr    | Balanced truncation for normalized coprime factors |
| hankelmr | Hankel minimum degree approximation                |
| hankelsv | Hankel singular value                              |

# repmat

---

**Purpose** Replicate and tile an array

**Syntax** `B = repmat(A,M,N)`

**Description** `B = repmat(A,M,N)` creates a large matrix B consisting of an M-by-N tiling of copies of A.

`B = repmat(A,[M N])` accomplishes the same result as `repmat(A,M,N)`.

`B = repmat(A,[M N P ...])` tiles the array A to produce an M-by-N-by-P-by-... block array. A can be N-D.

`repmat(A,M,N)` for scalar A is commonly used to produce an M-by-N matrix filled with values of A.

**Example** Simple examples of using repmat are:

```
repmat(randumat(2,2),2,3)
repmat(ureal('A',6),[4 2])
```



**Purpose** Create an options object for use with robuststab and robustperf

**Syntax**

```
opts = robopt
opts = robopt('name1',value1,'name2',value2,...)
```

**Description** options = robopt (with no input arguments) creates an options object with all the properties set to their default values.

options = robopt('name1',value1,'name2',value2,...) creates an robopt object in which specified properties have the given values. Any unspecified property is set to its default value. It is sufficient to type only enough leading characters to define the property name uniquely. Case is ignored for property names.

robopt with no input or output arguments displays a complete list of option properties and their default values.

### Fields

The following are the robopt object properties:

| Object Property | Description                                                                                                                      |
|-----------------|----------------------------------------------------------------------------------------------------------------------------------|
| Display         | Displays progress of computations. Default is 'off'                                                                              |
| Sensitivity     | Computes margin sensitivity to individual uncertainties. Default is 'on'                                                         |
| VaryUncertainty | Percentage variation of uncertainty used as a stepsize in finite-difference calculations to estimate sensitivity. Default is 25. |
| Mussv           | Option used in internal structured singular value calculations (when calling mussv). Default is 'sm9'.                           |

# robopt

| Object Property | Description                                                                          |
|-----------------|--------------------------------------------------------------------------------------|
| Default         | Structure, fieldnames are robopt properties, and values are the default values.      |
| Meaning         | Structure, fieldnames are robopt properties, and values text description of property |

## Example

You can create a robopt options object called opt with all default values.

```
opt = robopt
Property Object Values:
    Display: 'off'
    Sensitivity: 'on'
    VaryUncertainty: 25
    Mussv: 'sm9'
    Default: [1x1 struct]
    Meaning: [1x1 struct]
```

In estimating local sensitivities, an elementary finite-difference scheme is used. The property VaryUncertainty denotes the stepsize used in estimating the derivatives necessary in computing sensitivities.

In the following statements, you are requesting that the sensitivity of the robust stability margin calculation to a 50% variation individual uncertainties be calculated. The robopt options properties 'Sensitivity' and 'VaryUncertainty' are individually set.

```
opt = robopt;
opt.VaryUncertainty = 50;
opt
Property Object Values:
    Display: 'off'
    Sensitivity: 'on'
    VaryUncertainty: 50
    Mussv: 'sm9'
    Default: [1x1 struct]
    Meaning: [1x1 struct]
```

## See Also

|            |                                                   |
|------------|---------------------------------------------------|
| dkitopt    | Creates an options object for dksyn               |
| robuststab | Calculates stability margins of uncertain systems |

|                         |                                                         |
|-------------------------|---------------------------------------------------------|
| <code>robustperf</code> | Calculates performance margins of uncertain systems     |
| <code>wcgopt</code>     | Creates a <code>wcgain</code> option object             |
| <code>wcsens</code>     | Calculates worst-case sensitivities for a feedback loop |
| <code>wcmargin</code>   | Calculates worst-case margins for a feedback loop       |

# robustperf

---

**Purpose** Calculates the robust performance margin of an uncertain multivariable system. Largely included for historical purposes.

**Syntax**

```
perfmarg = robustperf(sys)
[perfmarg,wcu,report,info] = robustperf(sys)
[perfmarg,wcu,report,info] = robustperf(sys,opt)
```

**Description** The performance of a nominally-stable uncertain system model will generally degrade for specific values of its uncertain elements. `robustperf` computes the robust performance margin, which is one measure of the level of degradation brought on by the modeled uncertainty. The relationship between `robustperf` and other measures, such as `robuststab` and `wcgain`, is described in Chapter 7, “Generalized Robustness Analysis.”

As with other *uncertain-system* analysis tools, only bounds on the performance margin are computed. The exact robust performance margin is guaranteed to lie in between these upper and lower bounds.

The computation used in `robustperf` is a frequency-domain calculation. If the input system `sys` is a `ufrd`, then the analysis is performed on the frequency grid within the `ufrd`. If the input system `sys` is a `uss`, then an appropriate frequency grid is generated (automatically), and the analysis performed on that frequency grid. In all discussion that follows below,  $N$  denotes the number of points in the frequency grid.

## Basic syntax

Suppose `sys` is a `ufrd` or `uss` with  $M$  uncertain elements. The results of

```
[perfmarg,perfmargunc,Report] = robustperf(sys)
```

are such that `perfmarg` is a structure with the following fields

| Field      | Description                                                |
|------------|------------------------------------------------------------|
| LowerBound | Lower bound on robust performance margin, positive scalar. |

| Field             | Description                                                                                                                                                            |
|-------------------|------------------------------------------------------------------------------------------------------------------------------------------------------------------------|
| UpperBound        | Upper bound on robust performance margin, positive scalar.                                                                                                             |
| CriticalFrequency | The value of frequency at which the performance degradation curve crosses the $y=1/x$ curve. See section Generalized Robustness Analysis of the on-line documentation. |

`perfmargunc` is a struct of values of uncertain elements associated with the intersection of the performance degradation curve and the  $y=1/x$  curve. See Chapter 7, “Generalized Robustness Analysis.” There are  $M$  fieldnames, which are the names of uncertain elements of `sys`.

`Report` is a text description of the robust performance analysis results.

## Example

Create a plant with nominal model of an integrator, and include additive unmodeled dynamics uncertainty of a level of 0.4 (this corresponds to 100% model uncertainty at 2.5 rad/s).

```
P = tf(1,[1 0]) + ultidyn('delta',[1 1],'bound',0.4);
```

Design a “proportional” controller  $K$  which puts the nominal closed-loop bandwidth at 0.8 rad/sec. Roll-off  $K$  at a frequency 25 times the nominal closed-loop bandwidth. Form the closed-loop sensitivity function.

```
BW = 0.8;
K = tf(BW,[1/(25*BW) 1]);
S = feedback(1,P*K);
```

Assess the performance margin of the closed-loop sensitivity function. Since the nominal gain of the sensitivity function is 1, and the performance degradation curve is monotonically increasing (see Chapter 7, “Generalized Robustness Analysis”), the performance margin should be less than 1.

```
[perfmargin,punc] = robustperf(S);
perfmargin
perfmargin =
    UpperBound: 7.4305e-001
    LowerBound: 7.4305e-001
    CriticalFrequency: 5.3096e+000
```

You can verify that the upper bound of the performance margin corresponds to a point on or above the  $y=1/x$  curve. First compute the normalized size of the value of the uncertain element, and check that this agrees with the upper bound.

```
nsiz = actual2normalized(S.Uncertainty.delta, punc.delta)
nsiz =
perfmarg.UpperBound
ans =
    7.4305e-001
```

Compute the system gain with that value substituted, and verify that the product of the normalized size and the system gain is greater than or equal to 1.

```
gain = norm(usubs(S,punc),inf,.00001);
nsiz*gain
ans =
    1.0000e+000
```

Finally, as a sanity check, verify that the robust performance margin is less than the robust stability margin (it should always be, as described in Chapter 4, “Robustness Analysis”).

```
[stabmargin] = robuststab(S);
stabmargin
stabmargin =
    UpperBound: 3.1251e+000
    LowerBound: 3.1251e+000
    DestabilizingFrequency: 4.0862e+000
```

While the robust stability margin is easy to describe (poles migrating from stable region into unstable region), describing the robust performance margin is less elementary. See the diagrams and figures in Chapter 7, “Generalized Robustness Analysis.” Rather than finding values for uncertain elements which lead to instability, the analysis finds values of uncertain elements “corresponding to the intersection point of the performance degradation curve with a  $y=1/x$  hyperbola.” This characterization, mentioned above in the description of `perfmarg.CriticalFrequency` and `perfmargunc` will be used often in the descriptions below.

### Basic syntax with 4th output argument

A 4th output argument yields more specialized information, including sensitivities and frequency-by-frequency information.

```
[perfmarg,perfmargunc,Report,Info] = robustperf(sys)
```

In addition to the first 3 output arguments, described previous, Info is a structure with the following fields

| Field              | Description                                                                                                                                                                                                                                                                                                                                                                                                                                            |
|--------------------|--------------------------------------------------------------------------------------------------------------------------------------------------------------------------------------------------------------------------------------------------------------------------------------------------------------------------------------------------------------------------------------------------------------------------------------------------------|
| Sensitivity        | A struct with $M$ fields, fieldnames are names of uncertain elements of sys. Values of fields are positive, each the local sensitivity of the overall Stability Margin to that element's uncertainty range. For instance, a value of 25 indicates that if the uncertainty range is enlarged by 8%, then the stability margin should drop by about 2% (25% of 8). If the Sensitivity property of the robotp object is 'off', the values are set to NaN. |
| Frequency          | $N \times 1$ frequency vector associated with analysis.                                                                                                                                                                                                                                                                                                                                                                                                |
| BadUncertainValues | $N$ -by-1 cell array, with one entry for each frequency point. The $k$ 'th entry <code>Info.BadUncertainValues{k}</code> is a struct of values of uncertain elements resulting from a robust performance analysis at frequency <code>Info.Frequency(k)</code> .                                                                                                                                                                                        |
| MussvBnds          | A 1-by-2 frd, with upper and lower bounds from <code>mussv</code> . The (1,1) entry is the $\mu$ -upper bound (corresponds to <code>perfmarg.LowerBound</code> ) and the (1,2) entry is the $\mu$ -lower bound (for <code>perfmarg.UpperBound</code> ).                                                                                                                                                                                                |
| MussvInfo          | Structure of compressed data from <code>mussv</code> .                                                                                                                                                                                                                                                                                                                                                                                                 |

**Options** (e.g., controlling what is displayed during the computation, turning on/off the sensitivity computation, setting the “step-size” in the sensitivity computation, and controlling the option argument used in the underlying call to `mussv`) can be specified using the robustness analysis options `robotp` object.

For instance, you can turn the on display and turn off the sensitivity by executing

```
opt = robust('Sensitivity','off','Display','on');  
[PerfMarg, Destabunc, Report, Info] = robustperf(sys, opt)
```

## Handling array dimensions

If `sys` has array dimensions (for example, suppose that the size of `sys` is  $r \times c \times d_1 \times d_2 \times \dots \times d_F$ , refer to the  $d_1 \times d_2 \times \dots \times d_F$  as the *array dimensions*) then the margin calculation is performed “pointwise” (individually, at each and every array value) and the computed answers all have array dimensions as well. Details are described below. Again, assume that there are  $N$  frequency points and  $M$  uncertain elements.

The results of

```
[perfmarg, perfmargunc, Report, Info] = robustperf(sys, opt)
```

are `perfmarg` is a structure with the following fields

| Field             | Description                                                                                                                                                                                                                                                                                                                                                                                                         |
|-------------------|---------------------------------------------------------------------------------------------------------------------------------------------------------------------------------------------------------------------------------------------------------------------------------------------------------------------------------------------------------------------------------------------------------------------|
| LowerBound        | $d_1 \times \dots \times d_F$ , lower bound on stability margin across the array dimensions.                                                                                                                                                                                                                                                                                                                        |
| UpperBound        | $d_1 \times \dots \times d_F$ , upper bound on performance margin across the array dimensions. Using single-indexing, for each $i$ , the upper bound on the performance margin of <code>sys(:, :, i)</code> is <code>perfmarg.UpperBound(i)</code> .                                                                                                                                                                |
| CriticalFrequency | $d_1 \times \dots \times d_F$ , the value of frequency at which the performance degradation curve crosses the $y=1/x$ curve. Using single-indexing, for each $i$ , the frequency at which the performance degradation curve crosses the $y=1/x$ curve in robust performance analysis of <code>sys(:, :, i)</code> is <code>perfmarg.CriticalFrequency(i)</code> . See Chapter 7, “Generalized Robustness Analysis.” |



perfmargunc is a  $d_1 \times \dots \times d_F$  structure array of values of uncertain elements, associated with the intersection of the performance degradation curve and the  $y=1/x$  curve. See section **Generalized Robustness Analysis** of the on-line documentation. Using single-indexing, for each  $i$ , the struct of values of uncertain elements for uncertain system  $\text{sys}(:, :, i)$  is  $\text{perfmargunc}(i)$ .

Report is a character array, dimensions 3, 4, ..., F+2 are  $d_1 \times \dots \times d_F$ , containing text description of the robustness analysis results at each grid in the array dimensions.

In addition to the first 3 output arguments, described previous, Info is a structure with the following fields

| Field              | Description                                                                                                                                                                                                                                                                                                                                                                                          |
|--------------------|------------------------------------------------------------------------------------------------------------------------------------------------------------------------------------------------------------------------------------------------------------------------------------------------------------------------------------------------------------------------------------------------------|
| Sensitivity        | A $d_1 \times \dots \times d_F$ struct, fieldnames are names of uncertain elements of sys. Using single indexing notation, Sensitivity(i) contains the sensitivities of $\text{perfmarg.UpperBound}(i)$ for the uncertain system $\text{sys}(:, :, i)$ .                                                                                                                                             |
| Frequency          | $N \times 1$ frequency vector associated with analysis.                                                                                                                                                                                                                                                                                                                                              |
| BadUncertainValues | $N$ -by-1 cell array, with one entry for each frequency point. The $k$ 'th entry $\text{Info.BadUncertainValues}\{k\}$ is a $d_1 \times \dots \times d_F$ struct of values of uncertain elements resulting from a $d_1 \times \dots \times d_F$ family of robust performance computations at frequency $\text{Info.Frequency}(k)$ .                                                                  |
| MussvBnds          | $1 \times 2 \times d_1 \times \dots \times d_F$ frd, with upper and lower bounds from mussv. Using single-indexing for the dimensions associated with the array dimensions, it follows that the $(1, 1, i)$ entry is the $\mu$ -upper bound (reciprocal of $\text{perfmarg.UpperBound}(i)$ ) while the $(1, 2, i)$ entry is the $\mu$ -lower bound (reciprocal of $\text{perfmarg.UpperBound}(i)$ ). |
| MussvInfo          | Structure of compressed data from mussv.                                                                                                                                                                                                                                                                                                                                                             |

The smallest performance margin over all array dimensions can be computed `min(perfmarg.UpperBound(:))`. Computing

```
i = find(UpperBound==min(UpperBound(:)))
```

and then selecting `perfmargunc(i)` yields values for an uncertainty corresponding to the smallest performance margin across all array dimensions.

## Algorithm

A rigorous robust performance analysis consists of two steps:

- 1 verify that the nominal system is stable; and then
- 2 robust performance analysis on an augmented system.

The algorithm in `robustperf` follows this in spirit, but may require user attention.

If `sys` is a `uss` object, then the first requirement of stability of nominal value is explicitly checked within `robustperf`. However, if `sys` is an `ufrd`, then the verification of nominal stability from the nominal frequency response data is not performed, and is instead assumed.

The exact performance margin is guaranteed to be no larger than `UpperBound` (some uncertain elements associated with this magnitude cause instability – one instance is returned in the structure `perfmargunc`). The instability created by `perfmargunc` occurs at frequency value in `CriticalFrequency`.

Similarly, the exact performance margin is guaranteed to be no smaller than `LowerBound`.

## Limitations

Because the calculation is carried out with a frequency gridding, it is possible (likely) that the true critical frequency is missing from the frequency vector used in the analysis. This is similar to the problem in `robuststab`. However, in comparing to `robuststab`, the problem in `robustperf` is less acute. The robust performance margin, considered a function of problem data and frequency, is typically a continuous function (unlike the robust stability margin, described in the Robust Control Toolbox demo entitled *Getting Reliable Estimates of Robustness Margins* in the online documentation). Hence, in robust performance margin calculations, increasing the density of the frequency grid will always increase the accuracy of the answers, and in the limit, answers arbitrarily close to the actual answers are obtainable with finite frequency grids.

## See Also

|                                |                                                             |
|--------------------------------|-------------------------------------------------------------|
| <code>loopmargin</code>        | Comprehensive analysis of feedback loop.                    |
| <code>mussv</code>             | Calculate bounds on the Structured Singular Value ( $\mu$ ) |
| <code>norm</code>              | Calculate LTI system norms                                  |
| <code>robopt</code>            | Create a <code>robuststab/robustperf</code> options object  |
| <code>robuststab</code>        | Calculates stability margins of uncertain systems           |
| <code>actual2normalized</code> | Normalizes range of uncertain atoms                         |
| <code>wcgain</code>            | Calculate worst-case gain of uncertain systems              |
| <code>wcsens</code>            | Calculate worst-case sensitivities for feedback loop        |
| <code>wcmargin</code>          | Calculate worst-case margins for feedback loop              |

# robuststab

---

**Purpose**                    Calculates robust stability margins of an uncertain multivariable system.

**Syntax**                    `[stabmarg,destabunc,report,info] = robuststab(sys)`  
`[stabmarg,destabunc,report,info] = robuststab(sys,opt)`

**Description**            A nominally stable uncertain system will generally be unstable for specific values of its uncertain elements. Determining the values of the uncertain elements “closest” to their nominal values for which instability occurs is a *robust stability* calculation.

If the uncertain system is stable for all values of uncertain elements within their allowable ranges (ranges for `ureal`, norm bound or positive-real constraint for `ultidyn`, radius for `ucomplex`, weighted ball for `ucomplexm`), the uncertain system is *robustly stable*. Conversely, if there is a combination of element values that cause instability, and all lie within their allowable ranges, then the uncertain system is not robustly stable.

`robuststab` computes the margin of stability robustness for an uncertain system. A stability robustness margin greater than 1 means that the uncertain system is stable for all values of its modeled uncertainty. A stability robustness margin less than 1 implies that certain allowable values of the uncertain elements, within their specified ranges, lead to instability.

Numerically, a margin of 0.5 (for example) implies two things: the uncertain system remains stable for all values of uncertain elements which are less than 0.5 normalized units away from their nominal values; and, there is a collection of uncertain elements which are less than or equal to 0.5 normalized units away from their nominal values that results in instability. Similarly, a margin of 1.3 implies that the uncertain system remains stable for all values of uncertain elements up to 30% outside of their modeled uncertain ranges. See `actual2normalized` for converting between actual and normalized deviations from the nominal value of an uncertain element.

As with other *uncertain-system* analysis tools, only bounds on the exact stability margin are computed. The exact robust stability margin is guaranteed to lie in between these upper and lower bounds.

The computation used in `robuststab` is a frequency-domain calculation. If the input system `sys` is a `ufrd`, then the analysis is performed on the frequency grid within the `ufrd`. If the input system `sys` is a `uss`, then an appropriate

frequency grid is generated (automatically), and the analysis performed on that frequency grid. In all discussion that follows below,  $N$  denotes the number of points in the frequency grid.

### Basic syntax

Suppose `sys` is a `ufrd` or `uss` with  $M$  uncertain elements. The results of

```
[stabmarg,destabunc,Report] = robuststab(sys)
```

are `stabmarg` is a structure with the following fields

| Field                  | Description                                                                                                                                                                                                                                                                                                                                                                                             |
|------------------------|---------------------------------------------------------------------------------------------------------------------------------------------------------------------------------------------------------------------------------------------------------------------------------------------------------------------------------------------------------------------------------------------------------|
| LowerBound             | Lower bound on stability margin, positive scalar. If greater than 1, then the uncertain system is guaranteed stable for all values of the modeled uncertainty. If the nominal value of the uncertain system is unstable, then <code>stabmarg.UpperBound</code> and <code>stabmarg.LowerBound</code> will equal $-\infty$ .                                                                              |
| UpperBound             | Upper bound on stability margin, positive scalar. If less than 1, the uncertain system is not stable for all values of the modeled uncertainty.                                                                                                                                                                                                                                                         |
| DestabilizingFrequency | The critical value of frequency at which instability occurs, with uncertain elements “closest” to their nominal values. At a particular value of uncertain elements (see <code>destabunc</code> below), the poles migrate across the stability boundary (imaginary-axis in continuous-time systems, unit-disk in discrete-time systems) at the frequency given by <code>DestabilizingFrequency</code> . |

`destabunc` is a structure of values of uncertain elements, closest to nominal, which cause instability. There are  $M$  fieldnames, which are the names of uncertain elements of `sys`. The value of each field is the corresponding value of

the uncertain element, such that when jointly combined, lead to instability. The command `pole(usubs(sys,destabunc))` shows the instability. If `A` is an uncertain atom of `sys`, then

```
actual2normalized(destabunc.A,sys.Uncertainty.A)
```

will be less than or equal to `UpperBound`, and for at least one uncertain element of `sys`, this normalized distance will be equal to `UpperBound`, proving that `UpperBound` is indeed an upper bound on the robust stability margin.

`Report` is a text description of the robustness analysis results.

## Example

Construct a feedback loop with a second order plant and a PID controller with approximate differentiation. The second-order plant has frequency-dependent uncertainty, in the form of additive unmodeled dynamics, introduced with a `ultidyn` object and a shaping filter.

`robuststab` is used to compute the stability margins of the closed-loop system with respect to the plant model uncertainty.

```
P = tf(4,[1 .8 4]);
delta = ultidyn('delta',[1 1],'SampleStateDim',5);
Pu = P + 0.25*tf([1],[.15 1])*delta;
C = tf([1 1],[.1 1]) + tf(2,[1 0]);
S = feedback(1,Pu*C);
[stabmarg,destabunc,report,info] = robuststab(S);
```

You can view the `stabmarg` variable.

```
stabmarg
stabmarg =
    UpperBound: 0.8181
    LowerBound: 0.8181
    DestabilizingFrequency: 9.1321
```

As the margin is less than 1, the closed-loop system is not stable for plant models covered by the uncertain model `Pu`. There is a specific plant within the uncertain behavior modeled by `Pu` (actually about 82% of the modeled uncertainty) that leads to closed-loop instability, with the poles migrating across the stability boundary at 9.1 rads/s.

The `report` variable is specific, giving a plain-language version of the conclusion.

```

report
report =
UncertainSystem is NOT robustly stable to modeled uncertainty.
-- It can tolerate up to 81.8% of modeled uncertainty.
-- A destabilizing combination of 81.8% the modeled uncertainty
exists, causing an instability at 9.13 rad/s.
-- Sensitivity with respect to uncertain element ...
'delta' is 100%. Increasing 'delta' by 25% leads to a 25%
decrease in the margin.

```

Since the problem has only one uncertain element, the stability margin is completely determined by this element, and hence the margin exhibits 100% sensitivity to this uncertain element.

You can verify that the destabilizing value of delta is indeed about 0.82 normalized units from its nominal value.

```

actual2normalized(S.Uncertainty.delta,destabunc.delta)
ans =
    0.8181

```

Use `usubs` to substitute the specific value into the closed-loop system. Verify that there is a closed-loop pole near  $j9.1$ , and plot the unit-step response of the nominal closed-loop system, as well as the unstable closed-loop system.

```

Sbad = usubs(S,destabunc);
pole(Sbad)
ans =
    1.0e+002 *
    -3.2318
    -0.2539
    -0.0000 + 0.0913i
    -0.0000 - 0.0913i
    -0.0203 + 0.0211i
    -0.0203 - 0.0211i
    -0.0106 + 0.0116i
    -0.0106 - 0.0116i
step(S.NominalValue,'r--',Sbad,'g',4);

```

Finally, as an ad-hoc test, set the gain-bound on the uncertain delta to 0.81 (slightly less than the stability margin). Sample the closed-loop system at 100 values, and compute the poles of all of these systems.

```
S.Uncertainty.delta.Bound = 0.81;  
S100 = usample(S,100);  
p100 = pole(S100);  
max(real(p100(:)))  
ans =  
-6.4647e-007
```

As expected, all poles have negative real-parts.

## Basic syntax with 4th output argument

A 4th output argument yields more specialized information, including sensitivities and frequency-by-frequency information.

```
[StabMarg, Destabunc, Report, Info] = robuststab(sys)
```

In addition to the first 3 output arguments, described previous, Info is a structure with the following fields

| Field       | Description                                                                                                                                                                                                                                                                                                                                                                                                                                           |
|-------------|-------------------------------------------------------------------------------------------------------------------------------------------------------------------------------------------------------------------------------------------------------------------------------------------------------------------------------------------------------------------------------------------------------------------------------------------------------|
| Sensitivity | A struct with $M$ fields, fieldnames are names of uncertain elements of sys. Values of fields are positive, each the local sensitivity of the overall Stability Margin to that element's uncertainty range. For instance, a value of 25 indicates that if the uncertainty range is enlarged by 8%, then the stability margin should drop by about 2% (25% of 8). If the Sensitivity property of the robot object is 'off', the values are set to NaN. |
| Frequency   | $N \times 1$ frequency vector associated with analysis.                                                                                                                                                                                                                                                                                                                                                                                               |



| Field              | Description                                                                                                                                                                                                                                                                                                                                                                                                                                                                                                                                                                                                                                                                                                                                                                                                 |
|--------------------|-------------------------------------------------------------------------------------------------------------------------------------------------------------------------------------------------------------------------------------------------------------------------------------------------------------------------------------------------------------------------------------------------------------------------------------------------------------------------------------------------------------------------------------------------------------------------------------------------------------------------------------------------------------------------------------------------------------------------------------------------------------------------------------------------------------|
| BadUncertainValues | $N$ -by-1 cell array, with one entry for each frequency point. The $k$ 'th entry <code>Info.BadUncertainValues{k}</code> is a struct of values of uncertain elements, closest to their nominal values, which cause the system poles to migrate across the stability boundary at frequency <code>Info.Frequency(k)</code> . The command <code>pole(usubs(sys,Info.BadUncertainValues{k}))</code> shows the migration. The command <code>usubs(sys,cat(1,Info.BadUncertainValues{:}))</code> generates an $N$ -by-1 ss array. Each instance is unstable, with poles on the stability boundary at frequencies given by the vector <code>Info.Frequency</code> . This migration to instability has been achieved with the “smallest” normalized deviations in the uncertain elements from their nominal values. |
| MussvBnds          | A 1-by-2 frd, with upper and lower bounds from <code>mussv</code> . The (1,1) entry is the $\mu$ -upper bound (corresponds to <code>stabmarg.LowerBound</code> ) and the (1,2) entry is the $\mu$ -lower bound (for <code>stabmarg.UpperBound</code> ).                                                                                                                                                                                                                                                                                                                                                                                                                                                                                                                                                     |
| MussvInfo          | Structure of compressed data from <code>mussv</code> .                                                                                                                                                                                                                                                                                                                                                                                                                                                                                                                                                                                                                                                                                                                                                      |

**Options** (e.g., controlling what is displayed during the computation, turning on/off the sensitivity computation, setting the “step-size” in the sensitivity computation, and controlling the option argument used in the underlying call to `mussv`) can be specified using the robustness analysis options `robopt` object. For instance, you can turn the display on, and the sensitivity calculation off by executing

```
opt = robopt('Sensitivity','off','Display','on');
[StabMarg, Destabunc, Report, Info] = robuststab(sys, opt)
```

## Handling array dimensions

If `sys` has array dimensions (for example, suppose that the size of `sys` is  $r \times c \times d_1 \times d_2 \times \dots \times d_F$ , refer to the  $d_1 \times d_2 \times \dots \times d_F$  as the *array dimensions*) then the margin calculation is performed “pointwise” (individually, at each and every array value) and the computed answers all have array dimensions as well. Details are described below. Again, assume that there are  $N$  frequency points and  $M$  uncertain elements.

The results of

```
[stabmarg,destabunc,Report,Info] = robuststab(sys,opt)
```

are `stabmarg` is a structure with the following fields

| Field                  | Description                                                                                                                                                                                                                                                                                                              |
|------------------------|--------------------------------------------------------------------------------------------------------------------------------------------------------------------------------------------------------------------------------------------------------------------------------------------------------------------------|
| LowerBound             | $d_1 \times \dots \times d_F$ , lower bound on stability margin across the array dimensions.                                                                                                                                                                                                                             |
| UpperBound             | $d_1 \times \dots \times d_F$ , upper bound on stability margin across the array dimensions. Using single-indexing, for each $i$ , the upper bound on the stability margin of <code>sys(:, :, i)</code> is <code>stabmarg.UpperBound(i)</code> .                                                                         |
| DestabilizingFrequency | $d_1 \times \dots \times d_F$ , frequency at which instability occurs, associated with <code>stabmarg.UpperBound</code> . Using single-indexing, for each $i$ , the frequency at which instability occurs in robust stability analysis of <code>sys(:, :, i)</code> is <code>stabmarg.DestabilizingFrequency(i)</code> . |

`destabunc` is a  $d_1 \times \dots \times d_F$  structure array of values of uncertain elements, which cause instability. Using single-indexing, for each  $i$ , the destabilizing values of uncertain elements for uncertain system `sys(:, :, i)` is `destabunc(i)`.

`Report` is a character array, dimensions 3, 4, ...,  $F+2$  are  $d_1 \times \dots \times d_F$ , containing text description of the robustness analysis results at each grid in the array dimensions.

In addition to the first 3 output arguments, described previous, `Info` is a structure with the following fields

| Field              | Description                                                                                                                                                                                                                                                                                                                                                                                                                                                                                                                                                                                                                                                                                                              |
|--------------------|--------------------------------------------------------------------------------------------------------------------------------------------------------------------------------------------------------------------------------------------------------------------------------------------------------------------------------------------------------------------------------------------------------------------------------------------------------------------------------------------------------------------------------------------------------------------------------------------------------------------------------------------------------------------------------------------------------------------------|
| Sensitivity        | A $d_1 \times \dots \times d_F$ struct, fieldnames are names of uncertain elements of <code>sys</code> . Using single indexing notation, <code>Sensitivity(i)</code> contains the sensitivities of <code>stabmarg.UpperBound(i)</code> for the uncertain system <code>sys(:, :, i)</code> .                                                                                                                                                                                                                                                                                                                                                                                                                              |
| Frequency          | $N \times 1$ frequency vector associated with analysis.                                                                                                                                                                                                                                                                                                                                                                                                                                                                                                                                                                                                                                                                  |
| BadUncertainValues | $N$ -by-1 cell array, with one entry for each frequency point. The $k$ 'th entry <code>Info.BadUncertainValues{k}</code> is a $d_1 \times \dots \times d_F$ struct of values of uncertain elements, closest to their nominal values, which cause the system poles to migrate across the stability boundary at frequency <code>Info.Frequency(k)</code> . The command <code>usubs(sys, Info.BadUncertainValues{k})</code> produces an <code>ss</code> array of size $d_1 \times \dots \times d_F$ with the substitutions made. Alternatively, <code>usubs(sys, cat(F+1, Info.BadUncertainValues{:}))</code> produces an <code>ss</code> array of size $d_1 \times \dots \times d_F \times N$ with the substitutions made. |
| MussvBnds          | A $1 \times 2 \times d_1 \times \dots \times d_f$ frd, with upper and lower bounds from <code>mussv</code> . Using single-indexing for the dimensions associated with the array dimensions, it follows that the $(1, 1, i)$ entry is the $\mu$ -upper bound (corresponding to <code>stabmarg.LowerBound(i)</code> ) while the $(1, 2, i)$ entry is the $\mu$ -lower bound (which corresponds to <code>stabmarg.UpperBound(i)</code> ).                                                                                                                                                                                                                                                                                   |
| MussvInfo          | Structure of compressed data from <code>mussv</code> .                                                                                                                                                                                                                                                                                                                                                                                                                                                                                                                                                                                                                                                                   |

You can compute the smallest stability margin over all array dimensions via

```
min(stabmarg.UpperBound(:)).
```

Computing `i = find(UpperBound==min(UpperBound(:)))` and then `destabunc(i)` yields values for an uncertainty corresponding to the smallest stability margin across all array dimensions.

## Algorithm

A rigorous robust stability analysis consists of two steps:

- 1 verify that the nominal system is stable; and then
- 2 verify that no poles cross the stability boundary as the uncertain elements vary within their ranges.

Since the stability boundary is also associated with the frequency response, the second step can be interpreted (and carried out) as a frequency domain calculation. This amounts to a classical  $\mu$ -analysis problem.

The algorithm in `robuststab` follows this in spirit, but may require user attention.

If `sys` is a `uss` object, then the first requirement of stability of nominal value is explicitly checked within `robuststab`. However, if `sys` is an `ufrd`, then the verification of nominal stability from the nominal frequency response data is not performed, and is instead assumed.

In the second step (monitoring the stability boundary for the migration of poles), rather than check all points on stability boundary, the algorithm only detects migration of poles across the stability boundary at the frequencies in `info.Frequency`.

See the “Limitations” section below about issues related to migration detection.

The exact stability margin is guaranteed to be no larger than `UpperBound` (some uncertain elements associated with this magnitude cause instability – one instance is returned in the structure `destabunc`). The instability created by `destabunc` occurs at frequency value in `DestabilizingFrequency`.

Similarly, the exact stability margin is guaranteed to be no smaller than `LowerBound`. In other words, for all modeled uncertainty with magnitude up to `LowerBound`, the system is guaranteed stable. These bounds are derived using upper bound for the structured singular value, which is essentially optimally-scaled, small-gain theorem analysis.

## Limitations

Under most conditions, the robust stability margin that occurs at each frequency is a continuous function of the problem data at that frequency. Since the problem data, in turn, is a continuous function of frequency, it follows that finite frequency grids are usually adequate in correctly assessing robust stability bounds, assuming the frequency grid is “dense” enough.

Nevertheless, there are simple examples which violate this. In some problems, the migration of poles from stable to unstable *only* occurs at a finite collection of specific frequencies (generally unknown to you). Any frequency grid which excludes these critical frequencies (and almost every grid will exclude them) will result in undetected migration and misleading results, namely stability margins of  $\infty$ .

See the Robust Control Toolbox demo titled *Getting Reliable Estimates of Robustness Margins* in the online documentation about circumventing the problem in an engineering-relevant fashion.

## See Also

|            |                                                              |
|------------|--------------------------------------------------------------|
| loopmargin | Comprehensive analysis of a feedback loop                    |
| mussv      | Calculates bounds on the Structured Singular Value ( $\mu$ ) |
| robopt     | Creates a robuststab/robustperf options object               |
| robustperf | Calculates performance margins of uncertain systems          |
| wcgain     | Calculates worst-case gain of uncertain systems              |
| wcsens     | Calculates worst-case sensitivities for a feedback loop      |
| wcmargin   | Calculates worst-case margins for a feedback loop            |

# frd/schur

---

**Purpose** Schur decomposition of an frd object.

**Syntax**

```
[u,t] = schur(x)
      t = schur(x)
[u,t] = schur(x,0)
      t = schur(x,0)
[u,t] = schur(x,'econ')
      t = schur(x,'econ')
```

**Description** frd/schur applies the schur command to frd objects. [u,t] = schur(x) operates on x.ReponseData of the frd object at each frequency point to construct u and t. u and t are frd objects. x must be square. See the built in schur command for details.

**See Also**

|       |                                                        |
|-------|--------------------------------------------------------|
| qz    | Creates a QZ factorization for generalized eigenvalues |
| schur | Calculates a Schur decomposition                       |

**Purpose** Balanced model truncation via Schur method

**Syntax**

```
GRED = schurmr(G)
GRED = schurmr(G,order)
[GRED,redinfo] = schurmr(G,key1,value1,...)
[GRED,redinfo] = schurmr(G,order,key1,value1,...)
```

**Description** schurmr returns a reduced order model GRED of G and a struct array redinfo containing the error bound of the reduced model and Hankel singular values of the original system.

The error bound is computed based on Hankel singular values of G. For a stable system Hankel singular values indicate the respective state energy of the system. Hence, reduced order can be directly determined by examining the system Hankel SV's,  $\sigma$ .

With only one input argument G, the function will show a Hankel singular value plot of the original model and prompt for model order number to reduce.

This method guarantees an error bound on the infinity norm of the *additive error*  $\|G - GRED\|_{\infty}$  for well-conditioned model reduced problems [1]:

$$\|G - Gred\|_{\infty} \leq 2 \sum_{k=1}^n \sigma_k$$

This table describes input arguments for schurmr.

| Argument | Description                                                                                                                        |
|----------|------------------------------------------------------------------------------------------------------------------------------------|
| G        | LTI model to be reduced (without any other inputs will plot its Hankel singular values and prompt for reduced order).              |
| ORDER    | (Optional) an integer for the desired order of the reduced model, or optionally a vector packed with desired orders for batch runs |

A batch run of a serial of different reduced order models can be generated by specifying order = x:y, or a vector of integers. By default, all the anti-stable

part of a system is kept, because from control stability point of view, getting rid of unstable state(s) is dangerous to model a system.

'*MaxError*' can be specified in the same fashion as an alternative for 'ORDER'. In this case, reduced order will be determined when the sum of the tails of the Hankel sv's reaches the '*MaxError*'.

| Argument   | Value                                         | Description                                                                                                                |
|------------|-----------------------------------------------|----------------------------------------------------------------------------------------------------------------------------|
| 'MaxError' | A real number or a vector of different errors | Reduce to achieve $H_\infty$ error. When present, ' <i>MaxError</i> ' overrides ORDER input.                               |
| 'Weights'  | {Wout,Win} cell array                         | Optimal 1x2 cell array of LTI weights Wout (output) and Win (input); default is both identity; Weights must be invertible. |
| 'Display'  | 'on' or 'off'                                 | Display Hankel singular plots (default 'off').                                                                             |
| 'Order'    | Integer, vector or cell array                 | Order of reduced model. Use only if not specified as 2nd argument.                                                         |

Weights on the original model input and/or output can make the model reduction algorithm focus on some frequency range of interests. But weights have to be stable, minimum phase and invertible.



This table describes output arguments.

| Argument | Description                                                                                                                                                |
|----------|------------------------------------------------------------------------------------------------------------------------------------------------------------|
| GRED     | LTI reduced order model. Becomes multi-dimensional array when input is a serial of different model order array.                                            |
| REDINFO  | A STRUCT array with 3 fields: <ul style="list-style-type: none"> <li>• REDINFO.ErrorBound</li> <li>• REDINFO.StabSV</li> <li>• REDINFO.UnstabSV</li> </ul> |

G can be stable or unstable. G and GRED can be either continuous or discrete.

## Algorithm

Given a state space  $(A, B, C, D)$  of a system and  $k$ , the desired reduced order, the following steps will produce a similarity transformation to truncate the original state space system to the  $k^{th}$  order reduced model [16].

- 1 Find the controllability and observability grammians  $P$  and  $Q$ .
- 2 Find the Schur decomposition for  $PQ$  in both ascending and descending order, respectively,

$$V_A^T P Q V_A = \begin{bmatrix} \lambda_1 & \dots & \dots \\ 0 & \dots & \dots \\ 0 & 0 & \lambda_n \end{bmatrix}$$

$$V_D^T P Q V_D = \begin{bmatrix} \lambda_n & \dots & \dots \\ 0 & \dots & \dots \\ 0 & 0 & \lambda_1 \end{bmatrix}$$

- 3 Find the left/right orthonormal eigen-bases of  $PQ$  associated with the  $k^{th}$  big Hankel singular values.
- 4 Find the SVD of  $(V_{L,BIG}^T V_{R,BIG}) = U \Sigma V^T$

$$V_A = [V_{R,SMALL}, \overbrace{V_{L,BIG}}]$$

$$V_D = [\overbrace{V_{R,BIG}}, V_{L,SMALL}]$$

- 5 Form the left/right transformation for the final  $k^{th}$  order reduced model

$$S_{L,BIG} = V_{L,BIG} U \Sigma(1:k, 1:k)^{-1/2}$$

$$S_{R,BIG} = V_{R,BIG} V \Sigma(1:k, 1:k)^{-1/2}$$

- 6 Finally,

$$\left[ \begin{array}{c|c} \hat{A} & \hat{B} \\ \hline \hat{C} & \hat{D} \end{array} \right] = \left[ \begin{array}{c|c} S_{L,BIG}^T A S_{R,BIG} & S_{L,BIG}^T B \\ \hline C S_{R,BIG} & D \end{array} \right]$$

The proof of the Schur balance truncation algorithm can be found in [2].

## Example

Given a continuous or discrete, stable or unstable system, **G**, the following commands can get a set of reduced order models based on your selections:

```
rand('state',1234); randn('state',5678);G = rss(30,5,4);
[g1, redinfo1] = schurmr(G); % display Hankel SV plot
                        % and prompt for order (try 15:20)
[g2, redinfo2] = schurmr(G,20);
[g3, redinfo3] = schurmr(G,[10:2:18]);
[g4, redinfo4] = schurmr(G,'MaxError',[0.01, 0.05]);
rand('state',12345); randn('state',6789);
wt1 = rss(6,5,5); wt1.d = eye(5)*2;
wt2 = rss(6,4,4); wt2.d = 2*eye(4);
[g5, redinfo5] = schurmr(G, [10:2:18], 'weight',{wt1,wt2});
for i = 1:5
    figure(i); eval(['sigma(G,g' num2str(i) ');']);
end
```

## Reference

[1] K. Glover, "All Optimal Hankel Norm Approximation of Linear Multivariable Systems, and Their  $L_\infty$ - error Bounds," Int. J. Control, vol. 39, no. 6, pp. 1145-1193, 1984.

[2] M. G. Safonov and R. Y. Chiang, "A Schur Method for Balanced Model Reduction," *IEEE Trans. on Automat. Contr.*, vol. 34, no. 7, July 1989, pp. 729-733.

**See Also**

|          |                                                    |
|----------|----------------------------------------------------|
| reduce   | Top level model reduction routines                 |
| balancmr | Balanced truncation via square-root method         |
| bstmr    | Balanced stochastic truncation via Schur method    |
| ncfmr    | Balanced truncation for normalized coprime factors |
| hankelmr | Hankel minimum degree approximation                |
| hankelsv | Hankel singular value                              |

# sdhinfnorm

**Purpose** Computes the  $L_2$  norm of a continuous-time system in feedback with a discrete-time system

**Syntax**

```
[gaml,gamu] = sdhinfnorm(sdsys,k)
[gaml,gamu] = sdhinfnorm(sdsys,k,delay)
[gaml,gamu] = sdhinfnorm(sdsys,k,delay,tol)
```

**Description** `[gaml,gamu] = sdhinfnorm(sdsys,k)` computes the  $L_2$  induced norm of a continuous-time LTI plant, `sdsys`, in feedback with a discrete-time controller, `k`, connected through an ideal sampler and a zero-order hold (see figure below). `sdsys` must be strictly proper, such that the constant feedback gain must be zero. The outputs, `gamu` and `gaml`, are upper and lower bounds on the induced  $L_2$  norm of the sampled-data closed-loop system.

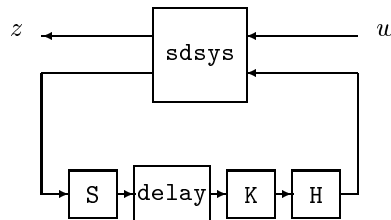

`[gaml,gamu] = sdhinfnorm(sdsys,k,h,delay)` includes the input argument, `delay`. `delay` is a non-negative integer associated with the number of computational delays of the controller. The default value of the delay is 0.

`[gaml,gamu] = sdhinfnorm(sdsys,k,h,delay,tol)` includes the input argument, `tol`, which defines the difference between upper and lower bounds when search terminates. The default value of `tol` is 0.001.

**Example** Consider an open-loop, continuous-time transfer function  $p = 30/s(s+30)$  and a continuous-time controller  $k = 4/(s+4)$ . The closed-loop continuous-time system has a peak magnitude across frequency of 1.

```
p = ss(tf(30,[1 30])*tf([1],[1 0]));
k = ss(tf(4,[1 4]));
cl = feedback(p,k);
norm(cl,'inf')
ans =
    1
```

Initially the controller is to be implemented at a sample rate of 1.5 Hz. The sample-data norm of the closed-loop system with the discrete-time controller is 1.0.

```
kd = c2d(k,0.75,'zoh');
[gu,gl] = sdhinfnorm([1; 1]*p*[1 1],-kd);
[gu gl]
ans =
    3.7908    3.7929
```

Due to the large difference in norm between the continuous-time and sampled-data closed-loop system, the sample rate of the controller is increased from 1.5 Hz to 5 Hz. The sample-data norm of new closed-loop system is 3.79.

```
kd = c2d(k,0.2,'zoh');
[gu,gl] = sdhinfnorm([1; 1]*p*[1 1],-kd);
[gu gl]
ans =
    1.0044    1.0049
```

## Algorithm

sdhinfnorm uses variations of the formulae described in the Bamieh and Pearson paper to obtain an equivalent discrete-time system. (These variations are done to improve the numerical conditioning of the algorithms.) A preliminary step is to determine whether the norm of the continuous-time system over one sampling period without control is less than the given-value. This requires a search and is, computationally, a relatively expensive step.

## Reference

Bamieh, B.A., and J.B. Pearson, "A General Framework for Linear Periodic Systems with Applications to Sampled-Data Control," *IEEE Transactions on Automatic Control*, vol. AC-37, pp. 418--435, 1992.

## See Also

|           |                                                         |
|-----------|---------------------------------------------------------|
| gapmetric | Computes the gap and the Vinnicombe gap metric          |
| hinfsyn   | Synthesizes a $H_\infty$ optimal controller             |
| norm      | Calculates the system norm of an LTI object             |
| sdhinfsyn | Synthesizes a sample-data $H_\infty$ optimal controller |
| sdlsim    | Simulates response of a sampled-data feedback system    |

# sdhifsyn

**Purpose** sdhifsyn computes an  $H_\infty$  controller for a sampled-data system.

**Syntax**  $[K, GAM] = \text{sdhifsyn}(P, NMEAS, NCON)$   
 $[K, GAM] = \text{sdhifsyn}(P, NMEAS, NCON, \text{KEY1}, \text{VALUE1}, \text{KEY2}, \text{VALUE2}, \dots)$

**Description** sdhifsyn is concerned with the control of a continuous-time LTI system  $P$  by a discrete-time controller  $K$ . The continuous-time LTI plant  $P$ , has state-space realization partitioned as follows

$$P = \left[ \begin{array}{c|cc} A & B_1 & B_2 \\ \hline C_1 & 0 & 0 \\ C_2 & 0 & 0 \end{array} \right]$$

where the continuous-time disturbance inputs enter through  $B_1$ , the outputs from the controller are held constant between sampling instants and enter through  $B_2$ , the continuous-time errors to be kept small correspond to the  $C_1$  partition, and the output measurements that are sampled by the controller correspond to the  $C_2$  partition.  $B_2$  has column size ( $ncon$ ) and  $C_2$  has row size ( $nmeas$ ). Note that the  $D$  matrix is must be zero.

sdhifsyn synthesizes a discrete-time LTI controller  $K$  to achieve a given norm (if possible) or find the minimum possible norm to within tolerance TOLGAM

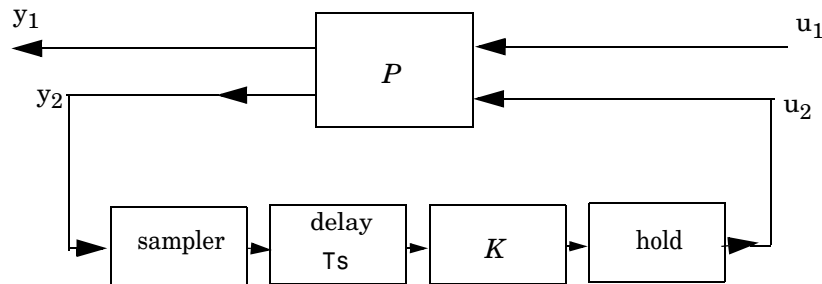

Similar to hifsyn, the function sdhifsyn employs a  $\gamma$  iteration. Given a high and low value of  $\gamma$ , GMAX and GMIN, the bisection method is used to iterate on the value of  $\gamma$  in an effort to approach the optimal  $H_\infty$  control design. If GMAX = GMIN, only one  $\gamma$  value is tested. The stopping criteria for the bisection algorithm

requires the relative difference between the last  $\gamma$  value that failed and the last  $\gamma$  value that passed be less than TOLGAM.

Input arguments:

P                    LTI plant  
 NMEAS             number of measurements output to controller  
 NCON               number of control inputs

Optional input arguments (KEY, VALUE) pairs are similar to hifsyn, but with additional KEY values 'Ts' and 'DELAY'.

| KEY       | VALUE         | MEANING                                                                                                   |
|-----------|---------------|-----------------------------------------------------------------------------------------------------------|
| 'GMAX'    | real          | initial upper bound on GAM (default=Inf)                                                                  |
| 'GMIN'    | real          | initial lower bound on GAM (default=0)                                                                    |
| 'TOLGAM'  | real          | relative error tolerance for GAM (default=.01)                                                            |
| 'Ts'      | real          | (default=1) sampling period of the controller to be designed                                              |
| 'DELAY'   | integer       | (default=0) a non-negative integer giving the number of sample periods delays for the control computation |
| 'DISPLAY' | 'off'<br>'on' | (default) no command window display, or command window displays synthesis progress information            |

Output arguments:

K                     $H_\infty$  controller  
 GAM                final  $\gamma$  value of  $H_\infty$  cost achieved

### Algorithm

sdhifsyn uses a variation of the formulae described in the Bamieh and Pearson paper [1] to obtain an equivalent discrete-time system. (This is done to improve the numerical conditioning of the algorithms.) A preliminary step is

to determine whether the norm of the continuous-time system over one sampling period without control is less than the given  $\gamma$ -value, this requires a search and is computationally a relatively expensive step.

## Reference

[1] Bamieh, B.A., and J.B. Pearson, "A General Framework for Linear Periodic Systems with Applications to Sampled-Data Control," *IEEE Transactions on Automatic Control*, vol. AC-37, pp. 418–435, 1992.

## See Also

|          |                                                |
|----------|------------------------------------------------|
| norm     | System norm of an LTI object                   |
| hinfosyn | Synthesize an $H_\infty$ optimal controller    |
| sdhinfo  | Calculate norm of sampled-data feedback system |



**Purpose** Time response of sampled-data feedback system.

**Syntax**

```
sdlsim(p,k,w,t,tf)
sdlsim(p,k,w,t,tf,x0,z0)
sdlsim(p,k,w,t,tf,x0,z0,int)
[vt,yt,ut,t] = sdlsim(p,k,w,t,tf)
[vt,yt,ut,t] = sdlsim(p,k,w,t,tf,x0,z0,int)
```

**Description** `sdlsim(p,k,w,t,tf)` plots the time response of the hybrid feedback system, `lft(p,k)`, is forced by the continuous input signal described by `w` and `t` (values and times, as in `lsim`). `p` must be a continuous-time LTI system, and `k` must be discrete-time LTI system, with a specified sampling time (the unspecified sampling time, -1, is not allowed). The final time is specified with `tf`.

`sdlsim(p,k,w,t,tf,x0,z0)` specifies the initial state vector `x0` of `p`, and `z0` of `k`, at time `t(1)`.

`sdlsim(p,k,w,t,tf,x0,z0,int)` specifies the continuous-time integration step size `int`. `sdlsim` forces `int = (k.Ts)/N int` where `N>4` is an integer. If any of these optional arguments are omitted, or passed as empty matrices, then default values are used. The default value for `x0` and `z0` is zero. Nonzero initial conditions are allowed for `p` (and/or `k`) only if `p` (and/or `k`) is an ss object.

If `p` and/or `k` are LTI arrays with consistent array dimensions, then the time simulation is performed “pointwise” across the array dimensions.

`[vt,yt,ut,t] = sdlsim(p,k,w,t,tf)` computes the continuous-time response of the hybrid feedback system `lft(p,k)` forced by the continuous input signal defined by `w` and `t` (values and times, as in `lsim`). `p` must be a continuous-time system, and `k` must be discrete-time, with a specified sampling time (the unspecified sampling time, -1, is not allowed). The final time is specified with `tf`. The outputs `vt`, `yt` and `ut` are 2-by-1 cell arrays: in each the first entry is a time vector, and the 2nd entry is the signal values. Stored in this manner, the signal `vt` can be plotted by using one of the following commands:

```
plot(vt{1},vt{2})
plot(vt{:})
```

Signals `yt` and `ut` are respectively the input to `k` and output of `k`.

If  $p$  and/or  $k$  are LTI arrays with consistent array dimensions, then the time simulation is performed “pointwise” across the array dimensions. The outputs are 2-by-1-by-Array Dimension cell arrays. All responses can be plotted simultaneously, for example, `plot(vt)`.

`[vt,yt,ut,t] = sdlsim(p,k,w,t,tf,x0,z0,int)` The optional arguments are `int` (integration step size), `x0` (initial condition for  $p$ ), and `z0` (initial condition for  $k$ ). `sdlsim` forces `int = (k.Ts)/N`, where  $N > 4$  is an integer. If any of these arguments are omitted, or passed as empty matrices, then default values are used. The default value for `x0` and `z0` is zero. Nonzero initial conditions are allowed for  $p$  (and/or  $k$ ) only if  $p$  (and/or  $k$ ) is an `ss` object.

## Example

To illustrate the use of `sdlsim`, consider the application of a discrete controller to an integrator with near integrator. A continuous plant and a discrete controller are created. A sample and hold equivalent of the plant is formed and the discrete closed-loop system is calculated. Simulating this with `lsim` gives the system response at the sample points. `sdlsim` is then used to calculate the intersample behavior.

```
P = tf(1,[1, 1e-5,0]);
T = 1.0/20;
C = ss([-1.5 T/4; -2/T -.5],[.5 2;1/T 1/T],...
      [-1/T^2 -1.5/T], [1/T^2 0],T);
Pd = c2d(P,T,'zoh');
```

The closed-loop digital system is now set up. You can use `sysic` to construct the interconnected feedback system.

```
systemnames = 'Pd C';
inputvar = '[ref]';
outputvar = '[Pd]';
input_to_Pd = '[C]';
input_to_C = '[ref ; Pd]';
sysoutname = 'dclp';
cleanup_sysic = 'yes';
sysic;
```

`lsim` is used to simulate the digital step response.

```
[yd,td] = step(dclp,20*T);
```

The continuous interconnection is set up and the sampled data response is calculated with `sdl`sim.

```
M = [0,1;1,0;0,1]*blkdiag(1,P);
t = [0:.01:1]';
u = ones(size(t));
y1 = sdl
```

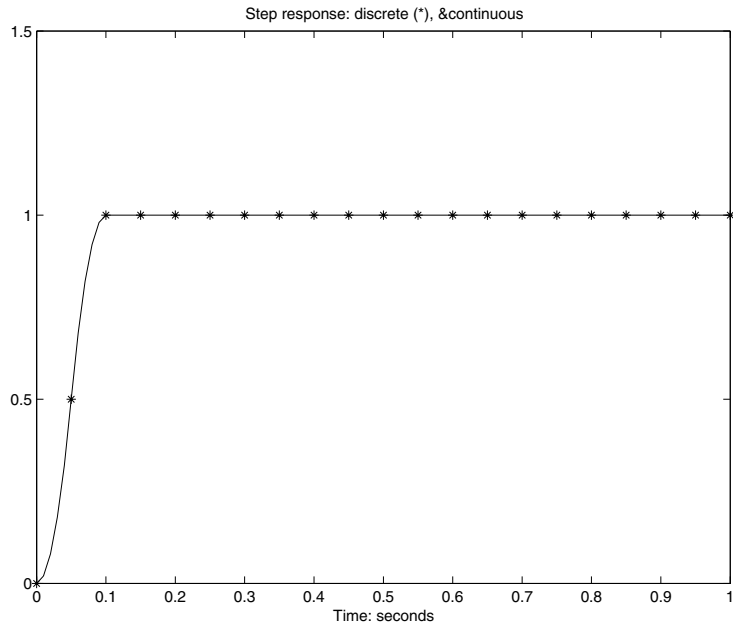

You can see the effect of a nonzero initial condition in the continuous-time system. Note how examining the system at only the sample points will underestimate the amplitude of the overshoot.

```
y2 = sdl
```

```
xlabel('Time: seconds')  
title('Step response: non zero initial condition')
```

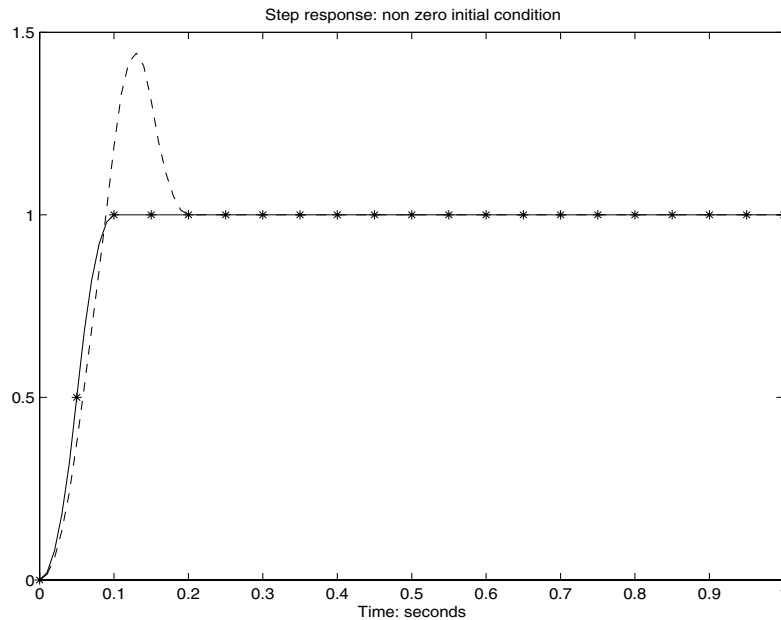

Finally, you can examine the effect of a sinusoidal disturbance at the continuous-time plant output. This controller has not been designed to reject such a disturbance and the system does not contain anti-aliasing filters. Simulating the effect of anti-aliasing filters is easily accomplished by including them in the continuous interconnection structure.

```
M2 = [0,1,1;1,0,0;0,1,1]*blkdiag(1,1,P);  
t = [0:.001:1]';  
dist = 0.1*sin(41*t);  
u = ones(size(t));  
[y3,meas,act] = sdlsim(M2,C,[u dist],t,1);  
plot(y3{:},'-' ,t,dist,'b--',t,u,'g-.')  
xlabel('Time: seconds')
```

```
title('Step response: disturbance (dashed) & output (solid)')
```

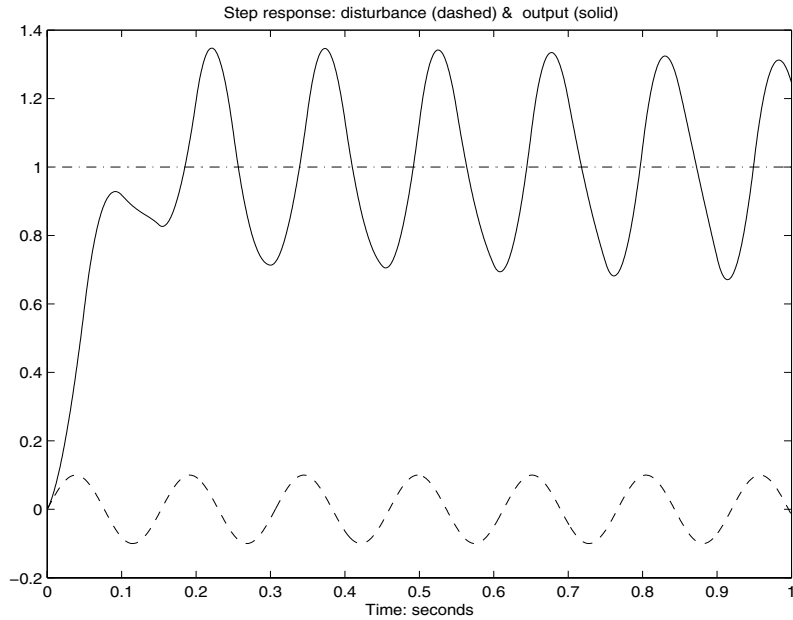

**Algorithm**

sdlsim over samples the continuous-time, N times the sample rate of the controller k.

**See Also**

- gapmetric            Computes the gap and the Vinnicombe gap metric
- hinfsyn             Synthesizes a  $H_\infty$  optimal controller
- norm                Computes the system norm of an LTI object
- sdhinfnorm         Calculates the norm of a sampled-data feedback system
- sdhinfsyn          Synthesizes a sample-data  $H_\infty$  optimal controller
- sdlsim              Simulates response of a sampled-data feedback system

# sectf

**Purpose** State-space sector bilinear transformation

**Syntax**  $[G, T] = \text{sectf}(F, \text{SECF}, \text{SECG})$

**Description**  $[G, T] = \text{sectf}(F, \text{SECF}, \text{SECG})$  computes a linear fractional transform  $T$  such that the system  $\text{lft}(F, K)$  is in sector  $\text{SECF}$  if and only if the system  $\text{lft}(G, K)$  is in sector  $\text{SECG}$  where

$$G = \text{lft}(T, F, NU, NY)$$

where  $NU$  and  $NY$  are the dimensions of  $u_{T2}$  and  $y_{T2}$ , respectively—see Figure 10-17.

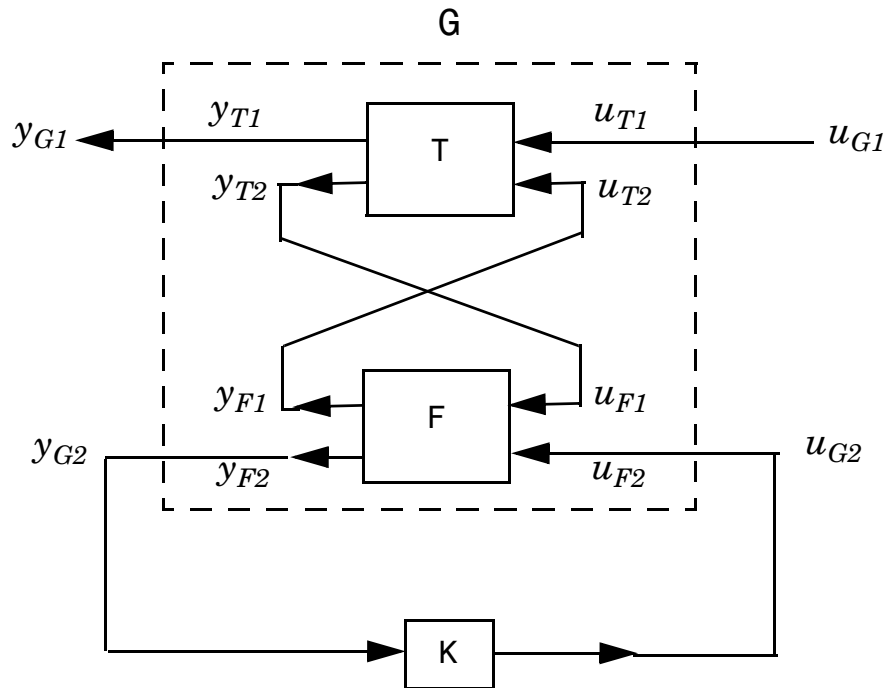

**Figure 10-17: Sector transform  $G = \text{lft}(T, F, NU, NY)$ .**

$\text{sectf}$  are used to transform general conic-sector control system performance specifications into equivalent  $H_\infty$ -norm performance specifications.

| <b>Input arguments:</b>                |                                                                  |
|----------------------------------------|------------------------------------------------------------------|
| F                                      | LTI state-space plant                                            |
| SECG, SECF:                            | Conic Sector:                                                    |
| $[-1, 1]$ or $[-1; 1]$                 | $\ y\ ^2 \leq \ u\ ^2$                                           |
| $[0, \text{Inf}]$ or $[0; \text{Inf}]$ | $0 \leq \text{Re}[y^*u]$                                         |
| $[A, B]$ or $[A; B]$                   | $0 \geq \text{Re}[(y - Au)^*(y - Bu)]$                           |
| $[a, b]$ or $[a; b]$                   | $0 \geq \text{Re}[(y - \text{diag}(a)u)^*(y - \text{diag}(b)u)]$ |
| S                                      | $0 \geq \text{Re}[(S_{11}u + S_{12}y)^*(S_{21}u + S_{22}y)]$     |
| S                                      | $0 \geq \text{Re}[(S_{11}u + S_{12}y)^*(S_{21}u + S_{22}y)]$     |

where A,B are scalars in  $[-\infty, \infty]$  or square matrices; a, b are vectors; S=[S11 S12; S21, S22] is a square matrix whose blocks S11, S12, S21, S22 are either scalars or square matrices; S is a two-port system S=mksys(a,b1,b2, 'tss') with transfer function

$$S(s) = \begin{bmatrix} S_{11}(s) & S_{12}(s) \\ S_{21}(s) & S_{22}(s) \end{bmatrix}$$

.)

| <b>Output arguments:</b> |                                                                     |
|--------------------------|---------------------------------------------------------------------|
| G                        | transformed plant $G(s)=\text{lftf}(T, F)$                          |
| T                        | LFT sector transform, maps conic sector SECF into conic sector SECG |

**Output variables are:**

- G                    The transformed plant  $G(s)=\text{lft}(T,F)$ :
- T                    The linear fractional transformation  $T(s)=T$

### Examples

The statement  $G(j\omega)$  inside *sector*[-1, 1] is equivalent to the  $H_\infty$  inequality

$$\sup_{\omega} \bar{\sigma}(G(j\omega)) = \|G\|_\infty \leq 1$$

Given a two-port open-loop plant  $P(s) := P$ , the command  $P1 = \text{sectf}(P, [0, \text{Inf}], [-1, 1])$  computes a transformed  $P_1(s) := P1$  such that if  $\text{lft}(G,K)$  is inside *sector*[-1, 1] if and only if  $\text{lft}(F,K)$  is inside *sector*[0,  $\infty$ ]. In other words,  $\text{norm}(\text{lft}(G,K), \text{inf}) < 1$  if and only if  $\text{lft}(F,K)$  is strictly positive real. See Figure 10-19

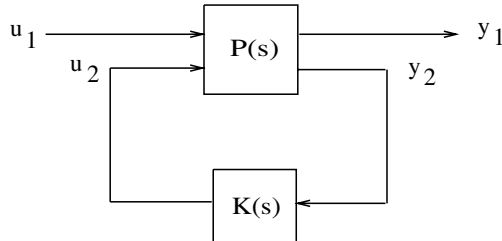

**Figure 10-18: Sector Transform Block Diagram.**

Here is a simple example of the sector transform.

$$P(s) = \frac{1}{s+1} \in \text{sector}[-1, 1] \rightarrow P_1(s) = \frac{s+2}{s} \in \text{sector}[0, \infty].$$

You can compute this by simply executing the following commands:

```

P = ss(tf(1,[1 1]));
P1 = sectf(P, [-1,1],[0, Inf]);

```

The Nyquist plots for this transformation are depicted in Figure 10-19, Example of Sector Transform.. The condition  $P_1(s)$  inside [0,  $\infty$ ] implies that  $P_1(s)$  is stable and  $P_1(j\omega)$  is *positive real*, i.e.,



$$P_1^*(j\omega) + P_1(j\omega) \geq 0 \quad \forall \omega$$

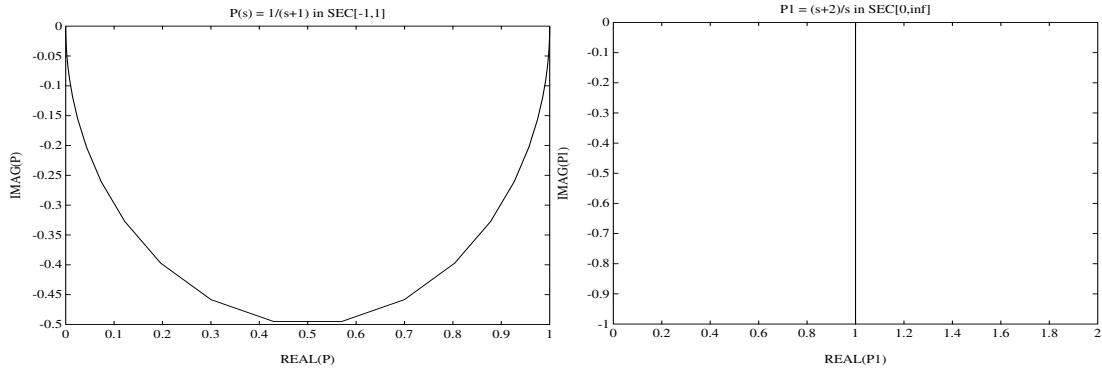

**Figure 10-19: Example of Sector Transform.**

## Algorithm

sectf uses the generalization of the sector concept of [3] described by [1]. First the sector input data Sf= SECF and Sg=SECG is converted to two-port state-space form; non-dynamical sectors are handled with empty  $a$ ,  $b1$ ,  $b2$ ,  $c1$ ,  $c2$  matrices. Next the equation

$$S_g(s) \begin{bmatrix} u_{g_1} \\ y_{g_1} \end{bmatrix} = S_f(s) \begin{bmatrix} u_{f_1} \\ y_{f_1} \end{bmatrix}$$

is solved for the two-port transfer function  $T(s)$  from  $u_{g_1} y_{f_1}$  to  $u_{f_1} y_{g_1}$ . Finally, the function lftf is used to compute  $G(s)$  as  $G=lftf(T,F)$ .

## Limitations

A well-posed conic sector must have  $\det(B - A) \neq 0$  or  $\det \begin{pmatrix} s_{11} & s_{12} \\ s_{21} & s_{22} \end{pmatrix} \neq 0$ .

Also, you must have  $\dim(u_{F1}) = \dim(y_{F1})$  since sectors are only defined for square systems.

## References

- [1] Safonov, M. G., *Stability and Robustness of Multivariable Feedback Systems*. Cambridge, MA: MIT Press, 1980.
- [2] Safonov, M. G., E. A. Jonckheere, M. Verma and D. J. N. Limebeer, "Synthesis of Positive Real Multivariable Feedback Systems," *Int. J. Control*, vol. 45, no. 3, pp. 817-842, 1987.
- [3] Zames, G., "On the Input-Output Stability of Time-Varying Nonlinear Feedback Systems  $\geq$ — Part I: Conditions Using Concepts of Loop Gain, Conicity, and Positivity," *IEEE Trans. on Automat. Contr.*, AC-11, pp. 228-238, 1966.

## See Also

|         |                                         |
|---------|-----------------------------------------|
| lft     | Forms Redheffer star product of systems |
| hinfsyn | $H_\infty$ controller synthesis         |

|                    |                                                                                                      |                                     |
|--------------------|------------------------------------------------------------------------------------------------------|-------------------------------------|
| <b>Purpose</b>     | Semi-log scale plot of a frd object.                                                                 |                                     |
| <b>Syntax</b>      | semilogx(...) same as plot                                                                           |                                     |
| <b>Description</b> | semilogx(...) is the same as plot(...), except a logarithmic (base 10) scale is used for the X-axis. |                                     |
| <b>See Also</b>    | loglog                                                                                               | Plot frd object on a log-log scale  |
|                    | plot                                                                                                 | Plot frd object on a linear scale   |
|                    | semilogy                                                                                             | Plot frd object on a semi-log scale |

# setlmis

---

**Purpose** Initialize the description of an LMI system

**Syntax** `setlmis(lmi0)`

**Description** Before starting the description of a new LMI system with `lmivar` and `lmiterm`, type

```
setlmis([])
```

to initialize its internal representation.

To add on to an existing LMI system, use the syntax

```
setlmis(lmi0)
```

where `lmi0` is the internal representation of this LMI system. Subsequent `lmivar` and `lmiterm` commands will then add new variables and terms to the initial LMI system `lmi0`.

|                 |                      |                                                |
|-----------------|----------------------|------------------------------------------------|
| <b>See Also</b> | <code>getlmis</code> | Get the internal description of an LMI system  |
|                 | <code>lmivar</code>  | Specify the matrix variables in an LMI problem |
|                 | <code>lmiterm</code> | Specify the term content of LMIs               |
|                 | <code>newlmi</code>  | Attach an identifying tag to LMIs              |

**Purpose** Instantiate a matrix variable and evaluate all LMI terms involving this matrix variable

**Syntax** `newsys = setmvar(lmisys,X,Xval)`

**Description** `setmvar` sets the matrix variable  $X$  with identifier  $X$  to the value  $Xval$ . All terms involving  $X$  are evaluated, the constant terms are updated accordingly, and  $X$  is removed from the list of matrix variables. A description of the resulting LMI system is returned in `newsys`.

The integer  $X$  is the identifier returned by `lmivar` when  $X$  is declared. Instantiating  $X$  with `setmvar` does not alter the identifiers of the remaining matrix variables.

The function `setmvar` is useful to freeze certain matrix variables and optimize with respect to the remaining ones. It saves time by avoiding partial or complete redefinition of the set of LMI constraints.

**Example** Consider the system

$$\dot{x} = Ax + Bu$$

and the problem of finding a stabilizing state-feedback law  $u = Kx$  where  $K$  is an unknown matrix.

By the Lyapunov Theorem, this is equivalent to finding  $P > 0$  and  $K$  such that

$$(A + BK)P + P(A + BK)^T + I < 0.$$

With the change of variable  $Y := KP$ , this condition reduces to the LMI

$$AP + PA^T + BY + Y^T B^T + I < 0.$$

This LMI is entered by the commands

```
n = size(A,1) % number of states
ncon = size(B,2) % number of inputs

setlmis([])
P = lmivar(1,[n 1]) % P full symmetric
Y = lmivar(2,[ncon n]) % Y rectangular

lmiterm([1 1 1 P],A,1,'s') % AP+PA'
```

## setmvar

---

```
lmiterm([1 1 1 Y],B,1,'s') % BY+Y'B'  
lmiterm([1 1 1 0],1) % I  
lmis = getlmis
```

To find out whether this problem has a solution  $K$  for the particular Lyapunov matrix  $P = I$ , set  $P$  to  $I$  by typing

```
news = setmvar(lmis,P,1)
```

The resulting LMI system `news` has only one variable  $Y = K$ . Its feasibility is assessed by calling `feasp`:

```
[tmin,xffeas] = feasp(news)  
Y = dec2mat(news,xffeas,Y)
```

The computed  $Y$  is feasible whenever  $tmin < 0$ .

### See Also

|                      |                                                                                                          |
|----------------------|----------------------------------------------------------------------------------------------------------|
| <code>evallmi</code> | Given a particular instance of the decision variables, evaluate all variable terms in the system of LMIs |
| <code>delmvar</code> | Delete one of the matrix variables of an LMI problem                                                     |

**Purpose** Return the left- and right-hand sides of an LMI after evaluation of all variable terms

**Syntax** `[lhs,rhs] = showlmi(evalsys,n)`

**Description** For given values of the decision variables, the function `evallmi` evaluates all variable terms in a system of LMIs. The left- and right-hand sides of the  $n$ -th LMI are then constant matrices that can be displayed with `showlmi`. If `evalsys` is the output of `evallmi`, the values `lhs` and `rhs` of these left- and right-hand sides are given by

```
[lhs,rhs] = showlmi(evalsys,n)
```

An error is issued if `evalsys` still contains variable terms.

**Example** See the description of `evallmi`.

**See Also**

|                      |                                                                                                          |
|----------------------|----------------------------------------------------------------------------------------------------------|
| <code>evallmi</code> | Given a particular instance of the decision variables, evaluate all variable terms in the system of LMIs |
| <code>setmvar</code> | Instantiate a matrix variable and evaluate all LMI terms involving this matrix variable                  |

# simplify

---

**Purpose** Simplify representations of uncertain objects

**Syntax**

```
B = simplify(A)
B = simplify(A,'full')
B = simplify(A,'basic')
B = simplify(A,'off')
```

**Description** `B = simplify(A)` performs model-reduction-like techniques to detect and eliminate redundant copies of uncertain elements. Depending on the result, the class of `B` may be lower than `A`. The `AutoSimplify` property of each uncertain element in `A` governs what reduction methods are used. After reduction, any uncertain element which does not actually affect the result is deleted from the representation.

`B = simplify(A,'full')` overrides all uncertain element's `AutoSimplify` property, and uses 'full' reduction techniques.

`B = simplify(A,'basic')` overrides all uncertain element's `AutoSimplify` property, and uses 'basic' reduction techniques.

`B = simplify(A,'off')` does not perform reduction. However, any uncertain elements in `A` with zero occurrences are eliminated, and the class of `B` may be lower than the class of `A`.

**Example** Create a simple umat with a single uncertain real parameter. Select specific elements, note that result remains in class umat. Simplify those same elements, and note that class changes.

```
p1 = ureal('p1',3,'Range',[2 5]);
L = [2 p1];
L(1)
UMAT: 1 Rows, 1 Columns
L(2)
UMAT: 1 Rows, 1 Columns
    p1: real, nominal = 3, range = [2 5], 1 occurrence
simplify(L(1))
ans =
     2
simplify(L(2))
Uncertain Real Parameter: Name p1, NominalValue 3, Range [2 5]
```



Create four uncertain real parameters, with a default value of `AutoSimplify('basic')`, and define a high order polynomial [1].

```
m = ureal('m',125000,'Range',[100000 150000]);
xcg = ureal('xcg',.23,'Range',[.15 .31]);
zcg = ureal('zcg',.105,'Range',[0 .21]);
va = ureal('va',80,'Range',[70 90]);
cw = simplify(m/(va*va)*va,'full')
UMAT: 1 Rows, 1 Columns
    m: real, nominal = 1.25e+005, range = [100000 150000], 1
occurrence
    va: real, nominal = 80, range = [70 90], 1 occurrence
cw = m/va;
fac2 = .16726*xcg*cw*cw*zcg - .17230*xcg*xcg*cw ...
      -3.9*xcg*cw*zcg - .28*xcg*xcg*cw*cw*zcg ...
      -.07*xcg*xcg*zcg + .29*xcg*xcg*cw*zcg ...
      + 4.9*xcg*cw - 2.7*xcg*cw*cw ...
      +.58*cw*cw - 0.25*xcg*xcg - 1.34*cw ...
      +100.1*xcg -14.1*zcg - 1.91*cw*cw*zcg ...
      +1.12*xcg*zcg + 24.6*cw*zcg ...
      +.45*xcg*xcg*cw*cw - 46.85
UMAT: 1 Rows, 1 Columns
    m: real, nominal = 1.25e+005, range = [100000 150000], 18
occurrences
    va: real, nominal = 80, range = [70 90], 8 occurrences
    xcg: real, nominal = 0.23, range = [0.15 0.31], 18 occurrences
    zcg: real, nominal = 0.105, range = [0 0.21], 1 occurrence
```

The result of the high-order polynomial is an inefficient representation involving 18 copies of `m`, 8 copies of `va`, 18 copies of `xcg` and 1 copy of `zcg`. Simplify the expression, using the `'full'` simplification algorithm

```
fac2s = simplify(fac2,'full')
UMAT: 1 Rows, 1 Columns
    m: real, nominal = 1.25e+005, range = [100000 150000], 4
occurrences
    va: real, nominal = 80, range = [70 90], 4 occurrences
    xcg: real, nominal = 0.23, range = [0.15 0.31], 2 occurrences
    zcg: real, nominal = 0.105, range = [0 0.21], 1 occurrence
```

which results in a much more economical representation.

Alternatively, change the AutoSimplify property of each parameter to 'full' before forming the polynomial.

```
m.AutoSimplify = 'full';
xcg.AutoSimplify = 'full';
zcg.AutoSimplify = 'full';
va.AutoSimplify = 'full';
```

You can form the polynomial, which immediately gives a low order representation.

```
cw = m/va;
fac2f = .16726*xcg*cw*cw*zcg - .17230*xcg*xcg*cw ...
        -3.9*xcg*cw*zcg - .28*xcg*xcg*cw*cw*zcg ...
        -.07*xcg*xcg*zcg + .29*xcg*xcg*cw*zcg ...
        + 4.9*xcg*cw - 2.7*xcg*cw*cw ...
        +.58*cw*cw - 0.25*xcg*xcg - 1.34*cw ...
        +100.1*xcg -14.1*zcg - 1.91*cw*cw*zcg ...
        +1.12*xcg*zcg + 24.6*cw*zcg ...
        +.45*xcg*xcg*cw*cw - 46.85
UMAT: 1 Rows, 1 Columns
      m: real, nominal = 1.25e+005, range = [100000 150000], 4
occurrences
      va: real, nominal = 80, range = [70 90], 4 occurrences
      xcg: real, nominal = 0.23, range = [0.15 0.31], 2 occurrences
      zcg: real, nominal = 0.105, range = [0 0.21], 1 occurrence
```

Create two real parameters, da and dx, and a 2-by-3 matrix, ABmat, involving polynomial expressions in the two real parameters [2].

```
da = ureal('da',0,'Range',[-1 1]);
dx = ureal('dx',0,'Range',[-1 1]);
a11 = -.32 + da*(.8089 + da*(-.987 + 3.39*da)) + .15*dx;
a12 = .934 + da*(.0474 - .302*da);
a21 = -1.15 + da*(4.39 + da*(21.97 - 561*da*da)) ...
      + dx*(9.65 - da*(55.7 + da*177));
a22 = -.66 + da*(1.2 - da*2.27) + dx*(2.66 - 5.1*da);
b1 = -0.00071 + da*(0.00175 - da*.00308) + .0011*dx;
b2 = -0.031 + da*(.078 + da*(-.464 + 1.37*da)) + .0072*dx;
ABmat = [a11 a12 b1;a21 a22 b2]
UMAT: 2 Rows, 3 Columns
      da: real, nominal = 0, range = [-1 1], 19 occurrences
```

```
dx: real, nominal = 0, range = [-1 1], 2 occurrences
```

Use 'full' simplification to reduce the complexity of the description.

```
ABmatsimp = simplify(ABmat, 'full')
UMAT: 2 Rows, 3 Columns
da: real, nominal = 0, range = [-1 1], 7 occurrences
dx: real, nominal = 0, range = [-1 1], 2 occurrences
```

Alternatively, you can set the parameter's AutoSimplify property to 'full'.

```
da.AutoSimplify = 'full';
dx.AutoSimplify = 'full';
```

Now you can rebuild the matrix

```
a11 = -.32 + da*(.8089 + da*(-.987 + 3.39*da)) + .15*dx;
a12 = .934 + da*(.0474 - .302*da);
a21 = -1.15 + da*(4.39 + da*(21.97 - 561*da*da)) ...
      + dx*(9.65 - da*(55.7 + da*177));
a22 = -.66 + da*(1.2 - da*2.27) + dx*(2.66 - 5.1*da);
b1 = -0.00071 + da*(0.00175 - da*.00308) + .0011*dx;
b2 = -0.031 + da*(.078 + da*(-.464 + 1.37*da)) + .0072*dx;
ABmatFull = [a11 a12 b1;a21 a22 b2]
UMAT: 2 Rows, 3 Columns
da: real, nominal = 0, range = [-1 1], 7 occurrences
dx: real, nominal = 0, range = [-1 1], 2 occurrences
```

## Algorithm

simplify uses heuristics along with one-dimensional model reduction algorithms to partially reduce the dimensionality of the representation of an uncertain matrix or system.

## Limitations

Multidimensional model reduction and realization theory are only partially complete theories. The heuristics used by simplify are that - heuristics. The order in which expressions involving uncertain elements are built up, eg., distributing across addition and multiplication, can affect the details of the representation (i.e., the number of occurrences of a ureal in an uncertain matrix). It is possible that simplify's naive methods cannot completely resolve these differences, so one may be forced to work with "nonminimal" representations of uncertain systems.

## References

[1] Varga, A. and G. Looye, "Symbolic and numerical software tools for LFT-based low order uncertainty modeling," *IEEE International Symposium on Computer Aided Control System Design*, pp. 5, 1999.

[2] Belcastro, C.M., K.B. Lim and E.A. Morelli, "Computer aided uncertainty modeling for nonlinear parameter-dependent systems Part II: F-16 example," *IEEE International Symposium on Computer Aided Control System Design*, pp. 17, 1999.

## See Also

|          |                                        |
|----------|----------------------------------------|
| umat     | Creates an uncertain matrix object     |
| uss      | Creates an uncertain system object     |
| ucomplex | Creates an uncertain complex parameter |
| ureal    | Creates an uncertain real parameter    |
| uss      | Creates an uncertain system            |

**Purpose** Form a skew-symmetric matrix

**Syntax** `x = skewdec(m,n)`

**Description** `skewdec(m,n)` forms the  $m$ -by- $m$  skew-symmetric matrix

$$\begin{bmatrix} 0 & -(n-1) & -(n-2) & \dots \\ (n+1) & 0 & -(n-3) & \dots \\ (n+2) & (n+3) & 0 & \dots \\ \dots & \dots & \dots & \dots \\ \dots & \dots & \dots & \dots \end{bmatrix}$$

This function is useful to define skew-symmetric matrix variables. In this case, set  $n$  to the number of decision variables already used.

**See Also**

|                      |                                                                                    |
|----------------------|------------------------------------------------------------------------------------|
| <code>decinfo</code> | Describe how the entries of a matrix variable $X$ relate to the decision variables |
| <code>lmivar</code>  | Specify the matrix variables in an LMI problem                                     |

# slowfast

---

**Purpose** Slow and fast modes decomposition

**Syntax** `[G1,G2] = slowfast(G,cut)`

**Description** `slowfast` computes the slow and fast modes decompositions of a system  $G(s)$  such that

$$G(s) = [G(s)]_s + [G(s)]_f$$

where  $[G(s)]_s := (\hat{A}_{11}, \hat{B}_1, \hat{C}_1, \hat{D}_1)$  denotes the slow part of  $G(s)$ , and

$[G(s)]_f := (\hat{A}_{22}, \hat{B}_2, \hat{C}_2, \hat{D}_2)$  denotes the fast part. The variable `cut` denotes the index where the modes will be split.

`stabproj` employs the algorithm in [1] as follows:

Find a unitary matrix  $V$  via the ordered Schur decomposition routines `blksch` or `rschur` such that

$$A = V^T A V = \begin{bmatrix} \hat{A}_{11} & \hat{A}_{12} \\ 0 & \hat{A}_{22} \end{bmatrix}$$

Based on the style of ordered Schur form, you get  $|\lambda_i(\hat{A}_{11})| < |\lambda_i(\hat{A}_{22})|$ .

Finally solving the matrix equation for  $X$

$$\hat{A}_{11}X - X\hat{A}_{22} + \hat{A}_{12} = 0$$

you get the state-space projections

$$[G(s)]_s := (\hat{A}_{11}, \hat{B}_1, \hat{C}_1, \hat{D}_1)$$

and

$$[G(s)]_f := (\hat{A}_{22}, \hat{B}_2, \hat{C}_2, \hat{D}_2)$$

where

$$\begin{bmatrix} \hat{B}_1 \\ \hat{B}_2 \end{bmatrix} := \begin{bmatrix} I & -X \\ 0 & I \end{bmatrix} VB$$

and

$$\begin{bmatrix} \hat{C}_1 & \hat{C}_2 \end{bmatrix} := CV^T \begin{bmatrix} I & X \\ 0 & I \end{bmatrix}$$

## References

- [1] M. G. Safonov, E. A. Jonckheere, M. Verma and D. J. N. Limebeer, "Synthesis of Positive Real Multivariable Feedback Systems", *Int. J. Control*, vol. 45, no. 3, pp. 817-842, 1987.

## See Also

|         |                                 |
|---------|---------------------------------|
| blkrsch | Block ordered Schur realization |
| cschur  | Complex Schur realization       |
| rschur  | Real Schur decomposition        |
| schur   | Schur decomposition             |
| modreal | Modal form realization          |

# squeeze

---

**Purpose** Remove singleton dimensions for umat objects

**Syntax** `B = squeeze(A)`

**Description** `B = squeeze(A)` returns an array B with the same elements as A but with all the singleton dimensions removed. A singleton is a dimension such that `size(A,dim)==1`. 2-D arrays are unaffected by `squeeze` so that row vectors remain rows.

**See Also**

|                      |                            |
|----------------------|----------------------------|
| <code>permute</code> | Permutes array dimensions. |
| <code>reshape</code> | Changes size of matrix     |



|                    |                                                                                                                                                                                                                                                                                                                                                                                                                                                                                                                                                                                                                                                                                                                                                                                                                                                                                                                                                                                                                                                                                                                                                                                                                                                                                                                                                                                                                                                                                                                                                                                                                                                                                                                                                                                                                                                                                                                                                                                                                                                                                                                                                |
|--------------------|------------------------------------------------------------------------------------------------------------------------------------------------------------------------------------------------------------------------------------------------------------------------------------------------------------------------------------------------------------------------------------------------------------------------------------------------------------------------------------------------------------------------------------------------------------------------------------------------------------------------------------------------------------------------------------------------------------------------------------------------------------------------------------------------------------------------------------------------------------------------------------------------------------------------------------------------------------------------------------------------------------------------------------------------------------------------------------------------------------------------------------------------------------------------------------------------------------------------------------------------------------------------------------------------------------------------------------------------------------------------------------------------------------------------------------------------------------------------------------------------------------------------------------------------------------------------------------------------------------------------------------------------------------------------------------------------------------------------------------------------------------------------------------------------------------------------------------------------------------------------------------------------------------------------------------------------------------------------------------------------------------------------------------------------------------------------------------------------------------------------------------------------|
| <b>Purpose</b>     | Scale state/uncertainty while preserving the uncertain input/output map of an uncertain system.                                                                                                                                                                                                                                                                                                                                                                                                                                                                                                                                                                                                                                                                                                                                                                                                                                                                                                                                                                                                                                                                                                                                                                                                                                                                                                                                                                                                                                                                                                                                                                                                                                                                                                                                                                                                                                                                                                                                                                                                                                                |
| <b>Syntax</b>      | <pre>usysout = ssbal(usys) usysout = ssbal(usys,Wc) usysout = ssbal(usys,Wc,FSflag) usysout = ssbal(usys,Wc,FSflag,BLTflag)</pre>                                                                                                                                                                                                                                                                                                                                                                                                                                                                                                                                                                                                                                                                                                                                                                                                                                                                                                                                                                                                                                                                                                                                                                                                                                                                                                                                                                                                                                                                                                                                                                                                                                                                                                                                                                                                                                                                                                                                                                                                              |
| <b>Description</b> | <p><code>usysout = ssbal(usys)</code> yields a system whose input/output and uncertain properties are the same as <code>usys</code>, an <code>uss</code> object. The numerical conditioning of <code>usysout</code> is usually better than that of <code>usys</code>, improving the accuracy of additional computations performed with <code>usysout</code>. <code>usysout</code> is an <code>uss</code> object. The balancing algorithm uses <code>mussv</code> to balance the constant uncertain state-space matrices in discrete-time. If <code>usys</code> is a continuous-time uncertain system, the uncertain state-space is mapped by using a bilinear transformation into discrete-time for balancing.</p> <p><code>usysout = ssbal(usys,wc)</code> defines the critical frequency, <code>wc</code>, for the bilinear prewarp transformation from continuous-time to discrete-time. The default value of <code>wc</code> is 1 when the nominal uncertain system is stable and <math>1.25 \cdot \text{mxeig}</math> when it is unstable. <code>mxeig</code> corresponds to the value of real of the most positive pole of <code>usys</code>.</p> <p><code>usysout = ssbal(usys,wc,FSflag)</code> sets the scaling flag, <code>FSflag</code>, to handle repeated uncertain parameters. Setting <code>FSflag=1</code> uses full matrix scalings to balance the repeated uncertain parameter blocks. <code>FSflag=0</code>, the default, uses a single, positive scalar to balance the repeated uncertain parameter blocks.</p> <p><code>usysout = ssbal(usys,wc,FSflag,BLTflag)</code> sets the bilinear transformation flag, <code>BLTflag</code>. By default, <code>BLTflag=1</code> and transforms the continuous-time system <code>usys</code> to a discrete-time system for balancing. <code>BLTflag=0</code> results in balancing the continuous-time state-space data from <code>usys</code>. Note that if <code>usys</code> is a discrete-time system, no bilinear transformation is performed.</p> <p><code>ssbal</code> does not work on an array of uncertain systems. An error message is generated to alert you of this.</p> |
| <b>Example</b>     | Consider a two-input, two-output, two-state uncertain system with two real parameter uncertainties, <code>p1</code> and <code>p2</code> .                                                                                                                                                                                                                                                                                                                                                                                                                                                                                                                                                                                                                                                                                                                                                                                                                                                                                                                                                                                                                                                                                                                                                                                                                                                                                                                                                                                                                                                                                                                                                                                                                                                                                                                                                                                                                                                                                                                                                                                                      |

```
p2=ureal('p2',-17,'Range',[-19 -11]);
p1=ureal('p1',3.2,'Percentage',0.43);
A = [-12 p1;.001 p2];
B = [120 -809;503 24];
C = [.034 .0076; .00019 2];
usys = ss(A,B,C,zeros(2,2))
USS: 2 States, 2 Outputs, 2 Inputs, Continuous System
  p1: real, nominal = 3.2, variability = [-0.43 0.43]%, 1
occurrence
  p2: real, nominal = -17, range = [-19 -11], 1 occurrence
usys.NominalValue
a =
      x1      x2
x1   -12     3.2
x2   0.001   -17

b =
      u1      u2
x1   120   -809
x2   503     24

c =
      x1      x2
y1   0.034  0.0076
y2  0.00019      2

d =
      u1  u2
y1    0   0
y2    0   0
```

Continuous-time model.

ssbal is used to balance the uncertain system, usys.

```
usysout = ssbal(usys)
USS: 2 States, 2 Outputs, 2 Inputs, Continuous System
  p1: real, nominal = 3.2, variability = [-0.43 0.43]%, 1
occurrence
  p2: real, nominal = -17, range = [-19 -11], 1 occurrence
```

```

usysout.NominalValue
a =
           x1      x2
x1      -12      0.3302
x2  0.009692      -17

b =
           u1      u2
x1  0.7802    -5.26
x2   31.7     1.512

c =
           x1      x2
y1    5.229    0.1206
y2  0.02922    31.74

d =
           u1  u2
y1    0    0
y2    0    0

```

Continuous-time model.

## See Also

|                           |                                                           |
|---------------------------|-----------------------------------------------------------|
| <code>canon</code>        | Forms canonical state-space realizations                  |
| <code>c2d</code>          | Converts continuous-time models to discrete-time          |
| <code>d2c</code>          | Converts discrete-time models to continuous-time          |
| <code>mussv</code>        | Sets bounds on the Structure Singular Value ( $\mu$ )     |
| <code>mussvextract</code> | Extracts compressed data returned from <code>mussv</code> |
| <code>ss2ss</code>        | Changes state coordinates for state-space models          |

# stabproj

---

**Purpose** Stable and antistable projection

**Syntax** `[G1,G2,m] = stabproj(G)`

**Description** `stabproj` computes the stable and antistable projections of a minimal realization  $G(s)$  such that  $G(s) = [G(s)]_- + [G(s)]_+$  where

$[G(s)]_- := (\hat{A}_{11}, \hat{B}_1, \hat{C}_1, \hat{D}_1)$  denotes the stable part of  $G(s)$ , and

$[G(s)]_+ := (\hat{A}_{22}, \hat{B}_2, \hat{C}_2, \hat{D}_2)$  denotes the antistable part. The variable `m` returns the number of stable eigenvalues of  $A$ .

**Algorithm** `stabproj` employs the algorithm in [1] as follows:

Find a unitary matrix  $V$  via the ordered Schur decomposition routines `blksc` or `rschur` such that

$$A = V^T A V = \begin{bmatrix} \hat{A}_{11} & \hat{A}_{12} \\ 0 & \hat{A}_{22} \end{bmatrix}$$

Based on the style of ordered Schur form, you can get a stable  $\hat{A}_{11}$  and an antistable  $\hat{A}_{22}$  ;  $|\lambda_i(\hat{A}_{11})| < |\lambda_i(\hat{A}_{22})|$  for the case of `slowfast`.

Finally solving the matrix equation for  $X$

$$\hat{A}_{11}X - X\hat{A}_{22} + \hat{A}_{12} = 0$$

you get the state-space projections  $[G(s)]_-$  or  $[G(s)]_s := (\hat{A}_{11}, \hat{B}_1, \hat{C}_1, \hat{D}_1)$

and  $[G(s)]_+$  or  $[G(s)]_{us} := (\hat{A}_{22}, \hat{B}_2, \hat{C}_2, \hat{D}_2)$

where

$$\begin{bmatrix} \hat{B}_1 \\ \hat{B}_2 \end{bmatrix} := \begin{bmatrix} I & -X \\ 0 & I \end{bmatrix} VB$$

and

$$\begin{bmatrix} \hat{C}_1 & \hat{C}_2 \end{bmatrix} := CV^T \begin{bmatrix} I & X \\ 0 & I \end{bmatrix}$$

## References

- [1] M. G. Safonov, E. A. Jonckheere, M. Verma and D. J. N. Limebeer, "Synthesis of Positive Real Multivariable Feedback Systems", *Int. J. Control*, vol. 45, no. 3, pp. 817-842, 1987.

## See Also

|         |                                 |
|---------|---------------------------------|
| blkrsch | Block ordered Schur realization |
| cschur  | Complex Schur realization       |
| rschur  | Real Schur decomposition        |
| schur   | Schur decomposition             |
| modreal | Modal form realization          |

**Purpose** Construct an array by stacking uncertain matrices, models, or arrays

**Syntax**

```
umatout = stack(arraydim,umat1,umat2,...)
usysout = stack(arraydim,usys1,usys2,...)
```

**Description** `stack` constructs an uncertain array by stacking uncertain matrices, models, or arrays along array dimensions of an uncertain array.

`umatout = stack(arraydim,umat1,umat2,...)` produces an array of uncertain matrices, `umatout`, by stacking (concatenating) the `umat` matrices (or `umat` arrays) `umat1,umat2,...` along the array dimension `arraydim`. All models must have the same number of columns and rows. The column/row dimensions are not counted in the array dimensions.

`umatout = stack(arraydim,usys1,usys2,...)` produces an array of uncertain models, `ufrd` or `uss`, or `usysout`, by stacking (concatenating) the `ufrd` or `uss` matrices (or `ufrd` or `uss` arrays) `usys1,usys2,...` along the array dimension `arraydim`. All models must have the same number of columns and rows (the same input/output dimensions). Note that the input/output dimensions are not considered for arrays.

**Example** Consider `usys1` and `usys2`, two single-input/single-output `uss` models:

```
zeta = ureal('zeta',1,'Range',[0.4 4]);
wn = ureal('wn',0.5,'Range',[0.3 0.7]);
P1 = tf(1,[1 2*zeta*wn wn^2]);
P2 = tf(zeta,[1 10]);
```

You can stack along the first dimension to produce a 2-by-1 `uss` array.

```
stack(1,P1,P1)
USS: 2 States, 1 Output, 1 Input, Continuous System [array, 2 x 1]
    wn: real, nominal = 0.5, range = [0.3 0.7], 3 occurrences
    zeta: real, nominal = 1, range = [0.4 4], 1 occurrence
```

You can stack along the second dimension to produce a 1-by-2 `uss` array.

```
stack(2,P1,P2) % produces a 1-by-2 USS array.
USS: 2 States, 1 Output, 1 Input, Continuous System [array, 1 x 2]
    wn: real, nominal = 0.5, range = [0.3 0.7], 3 occurrences
    zeta: real, nominal = 1, range = [0.4 4], 1 occurrence
```

You can stack along the third dimension to produce a 1-by-1-by-2 USS array.

```
stack(3,P1,P2) % produces a 1-by-1-by-2 USS array.  
USS: 2 States, 1 Output, 1 Input, Continuous System [array, 1 x 1  
x 2]  
  wn: real, nominal = 0.5, range = [0.3 0.7], 3 occurrences  
  zeta: real, nominal = 1, range = [0.4 4], 1 occurrence
```

## See Also

|         |                                                     |
|---------|-----------------------------------------------------|
| append  | Groups models by appending their inputs and outputs |
| blkdiag | Groups models by appending their inputs and outputs |
| horzcat | Performs horizontal concatenation                   |
| vertcat | Performs vertical concatenation                     |

# frd/svd

---

**Purpose** Singular value decomposition of a frd object

**Syntax**  $S = \text{svd}(X)$   
 $[U, S, V] = \text{svd}(X)$

**Description**  $S = \text{svd}(X)$  operates on  $X$ .ReponseData at each frequency to construct  $S$ .  
 $[U, S, V] = \text{svd}(X)$  produces a diagonal frd  $S$  that has the same dimensions as  $X$  and includes positive diagonal elements in decreasing order.  $U$  and  $V$  are unitary matrices and frd objects, such that  $X = U*S*V'$ . For more information, see the built in svd command for more details.

**See Also** schur Constructs a Schur decomposition  
svd Constructs a singular value decomposition



**Purpose** Form a symmetric matrix

**Syntax** `x = symdec(m,n)`

**Description** `symdec(m,n)` forms an m-by-m symmetric matrix of the form

$$\begin{bmatrix} (n+1) & (n+2) & (n+4) & \dots \\ (n+2) & (n+3) & (n+5) & \dots \\ (n+4) & (n+5) & (n+6) & \dots \\ \dots & \dots & \dots & \dots \\ \dots & \dots & \dots & \dots \end{bmatrix}$$

This function is useful to define symmetric matrix variables. `n` is the number of decision variables.

**See Also** `decinfo` Show how matrix variables depend on decision variables

# sysic

---

**Purpose** Build interconnections of certain and uncertain matrices and systems.

**Syntax** `sysout = sysic`

**Description** `sysic` requires that 3 variables with fixed names are present in the calling workspace: `systemnames`, `inputvar` and `outputvar`.

`systemnames` is a char, containing the names of the subsystems (`double`, `tf`, `zpk`, `ss`, `uss`, `frd`, `ufrd`, etc) that comprise the interconnection. The names must be separated by spaces with no additional punctuation. Each named variable must exist in the calling workspace.

`inputvar` is a char, defining the names of the external inputs to the interconnection. The names are separated by semicolons, and the entire list is enclosed in square brackets [ ]. Inputs can be scalar or multivariate. For instance, a 3-component ( $x, y, z$ ) force input can be specified with 3 separate names, `Fx`, `Fy`, `Fz`. Alternatively, a single name with a defined integer dimension can be specified, as in `F{3}`. The order of names in `inputvar` determines the order of inputs in the interconnection.

`outputvar` is a char, describing the outputs of the interconnection. Outputs do not have names – they are simply linear combinations of individual subsystem’s outputs and external inputs. Semicolons delineate separate components of the interconnection’s outputs. Between semicolons, signals can be added and subtracted, and multiplied by scalars. For multivariable subsystems, arguments within parentheses specify which subsystem outputs are to be used and in what order. For instance `plant(2:4,1,9:11)` specifies outputs 2,3,4,1,9,10,11 from the subsystem `plant`. If a subsystem is listed in `outputvar` without arguments, then all outputs from that subsystem are used.

`sysic` also requires that for every subsystem name listed in `systemnames`, a corresponding variable, `input_to_ListedSubSystemName` must exist in the calling workspace. This variable is similar to `outputvar` – it defines the input signals to this particular subsystem as linear combinations of individual subsystem’s outputs and external inputs.

`sysout = sysic` will perform the interconnection described by the variables above, using the subsystem data in the names found in `systemnames`. The

resulting interconnection will be returned in the output argument, listed above as sysout.

**Example**

A simple system interconnection, identical to the system illustrated in the iconnect description. Consider a three-input, two-output LTI matrix  $T$ ,

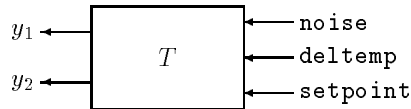

which has internal structure

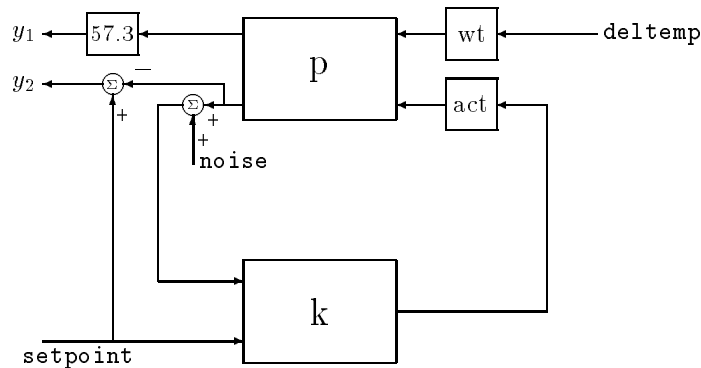

```
P = rss(3,2,2);
K = rss(1,1,2);
A = rss(1,1,1);
W = rss(1,1,1);
systemnames = 'W A K P';
inputvar = '[noise;deltemp;setpoint]';
outputvar = '[57.3*P(1);setpoint-P(2)]';
input_to_W = '[deltemp]';
input_to_A = '[K]';
input_to_K = '[P(2)+noise;setpoint]';
input_to_P = '[W;A]';
T = sysic;
```

# sysic

---

## Limitations

The syntax of `sysic` is limited, and for the most part is restricted to what is shown here. The `iconnect` interconnection object can also be used to define complex interconnections, and has a more flexible syntax.

Within `sysic`, error-checking routines monitor the consistency and availability of the subsystems and their inputs. These routines provide a basic level of error detection to aid the user in debugging.

## See Also

`iconnect`

Equates expressions for `icsignal` objects

## Purpose

Create an uncertain complex parameter

## Syntax

```
A = ucomplex('NAME',nominalvalue)
A = ucomplex('NAME',nominalvalue,'Property1',Value1,...
            'Property2',Value2,...)
```

## Description

An uncertain complex parameter is used to represent a complex number whose value is uncertain. Uncertain complex parameters have a name (the Name property), and a nominal value (the NominalValue property).

The uncertainty (potential deviation from the nominal value) is described in two different manners:

- Radius (radius of disc centered at NominalValue)
- Percentage (disc size is percentage of magnitude of NominalValue)

The Mode property determines which description remains invariant if the NominalValue is changed (the other is derived). The default Mode is 'Radius' and the default radius is 1.

Property/Value pairs may also specified upon creation. For instance,

- `B = ucomplex('B',6-j,'Percentage',25)`

sets the nominal value to  $6 - j$ , the percentage uncertainty to be 25 and, implicitly, the Mode to 'Percentage'.

## Example

Create an uncertain complex parameter with internal name A. The uncertain parameter's possible values are a complex disc of radius 1, centered at  $4+3j$ . The value of A.percentage is 20 (radius is  $1/5$  of the magnitude of the nominal value).

```
A = ucomplex('A',4+3*j)
Uncertain Complex Parameter: Name A, NominalValue 4+3i, Radius 1
```

You can visualized the uncertain complex parameter by sampling and plotting the data.

```
sa = usample(A,400);
w = linspace(0,2*pi,200);
circ = sin(w) + j*cos(w);
rc = real(A.NominalValue+circ);
```

# ucomplex

```
ic = imag(A.NominalValue+circ);  
plot(real(sa(:)),imag(sa(:)), 'o',rc,ic, 'k-')  
xlim([2.5 5.5])  
ylim([1.5 4.5])  
axis equal
```

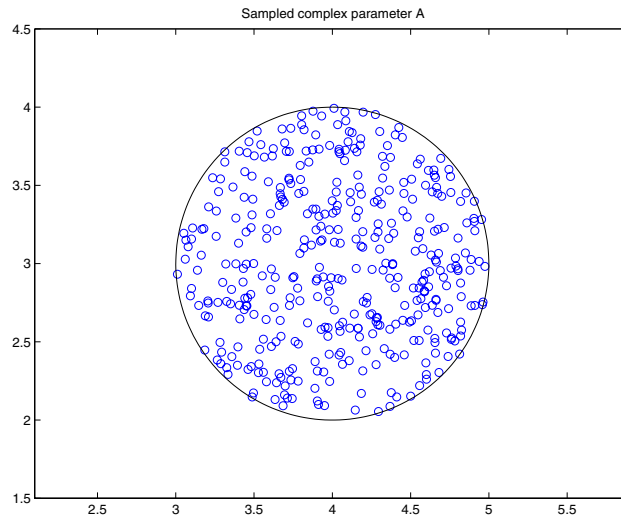

## See Also

|           |                                         |
|-----------|-----------------------------------------|
| get       | Gets object properties                  |
| umat      | Creates an uncertain matrix object      |
| ucomplexm | Creates an uncertain complex matrix     |
| ultidyn   | Creates an uncertain LTI dynamic object |
| ureal     | Creates an uncertain real parameter     |

**Purpose** Create uncertain complex matrix

**Syntax**

```
M = ucomplexm('Name',NominalValue)
M = ucomplexm('Name',NominalValue,'WL',WLvalue,'WR',WRvalue)
M = ucomplexm('Name',NominalValue,'Property',Value)
```

**Description** `M = ucomplexm('Name',NominalValue)` creates an uncertain complex matrix represents a “ball” of complex-valued matrices, centered at a `NominalValue` and named `Name`.

`M = ucomplexm('Name',NominalValue,'WL',WLvalue,'WR',WRvalue)` creates an uncertain complex matrix with weights `WL` and `WR`. Specifically, the values represented by `M` are all matrices `H` which satisfy  $\text{norm}(\text{inv}(M.WL) * (H - M.NominalValue) * \text{inv}(M.WR)) \leq 1$ . `WL` and `WR` are square, invertible, and weighting matrices that quantify the size and shape of the ball of matrices represented by this object. The default values for `WL` and `WR` are identity matrices of appropriate dimensions.

Trailing `Property/Value` pairs are allowed, as in

```
M = ucomplexm('NAME',nominalvalue,'P1',V1,'P2',V2,...)
```

The property `AutoSimplify` controls how expressions involving the uncertain matrix are simplified. Its default value is `'basic'`, which means elementary methods of simplification are applied as operations are completed. Other values for `AutoSimplify` are `'off'`, no simplification performed, and `'full'` which applies model-reduction-like techniques to the uncertain object.

**Example** Create a `ucomplexm` with the name `'F'`, nominal value `[1 2 3; 4 5 6]`, and weighting matrices `WL = diag([.1 .3])`, `WR = diag([.4 .8 1.2])`.

```
F = ucomplexm('F',[1 2 3;4 5 6],'WL',diag([.1 .3]),...
'WR',diag([.4 .8 1.2]));
```

Sample the difference between the uncertain matrix and its nominal value at 80 points, yielding a 2-by-3-by-80 matrix `typicaldev`.

```
typicaldev = usample(F-F.NominalValue,40);
```

Plot histograms of the deviations in the (1,1) entry as well as the deviations in the (2,3) entry.

# ucomplexm

The absolute value of the (1,1) entry and the (2,3) entry are shown by histogram plots. Typical deviations in the (1,1) entry should be about 10 times smaller than the typical deviations in the (2,3) entry.

```
subplot(2,1,1);  
hist(abs(typicaldev(1,1,:)));xlim([0 .25])  
title('Sampled F(1,1) - F(1,1).NominalValue')  
subplot(2,1,2);  
hist(abs(typicaldev(2,3,:)));xlim([0 .25])  
title('Sampled F(2,3) - F(2,3).NominalValue')
```

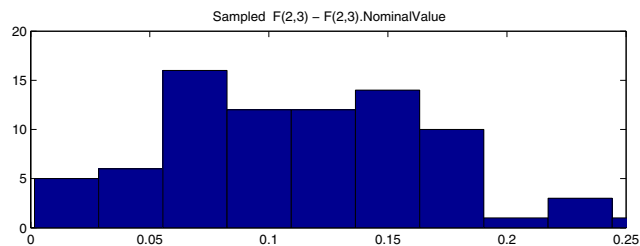
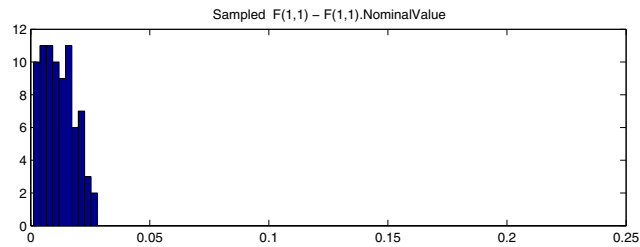

## See Also

|           |                                         |
|-----------|-----------------------------------------|
| get       | Gets object properties                  |
| umat      | Creates an uncertain matrix object      |
| ucomplexm | Creates an uncertain complex parameter  |
| ultidyn   | Creates an uncertain LTI dynamic object |
| ureal     | Creates an uncertain real parameter     |



**Purpose** Create an unstructured uncertain dynamic system object.

**Syntax** `n = udyn('name',iosize);`

**Description** `n = udyn('name',iosize)` creates an unstructured uncertain dynamic system class, with input/output dimension specified by `iosize`. This object represents the class of completely unknown multivariable, time-varying nonlinear systems.

For practical purposes, these uncertain elements represent noncommuting symbolic variables (placeholders). All algebraic operations, such as addition, subtraction, multiplication (i.e., cascade) operate properly, and substitution (with `usubs`) is allowed.

The analysis tools (e.g., `robuststab`) do not currently handle these types of uncertain elements. As such, these elements do not provide a significant amount of usability, and their role in the toolbox is small.

**Example** You can create a 2-by-3 `udyn` element and check its size and properties.

```
N = udyn('N',[2 3])
Uncertain Dynamic System: Name N, size 2x3
size(N)
ans =
     2     3
get(N)
      Name: 'N'
      NominalValue: [2x3 double]
      AutoSimplify: 'basic'
```

**See Also**

|                        |                                                   |
|------------------------|---------------------------------------------------|
| <code>ureal</code>     | Creates an uncertain real parameter               |
| <code>ultidyn</code>   | Creates an uncertain linear time-invariant object |
| <code>ucomplex</code>  | Creates an uncertain complex parameter            |
| <code>ucomplexm</code> | Creates an uncertain complex matrix               |

# ufrd

---

**Purpose** Create an uncertain frequency response data (ufrd) object, or convert another model type to a ufrd model.

**Syntax**

```
usysufrd = ufrd(usys,frequency)
usysufrd = ufrd(usys,frequency,'Units',units)
usysufrd = ufrd(sysufrd)
usys = ufrd(response,frequency)
usys = ufrd(response,frequency,Ts)
usys = ufrd(response,frequency,RefSys)
usys = ufrd(response,frequency,'Units',units,Ts)
usys = ufrd(response,frequency,'Units',units,Ts,RefSys)
```

**Description** Uncertain frequency response data (ufrd) models results from the conversion of an uncertain state-space (uss) system to its uncertain frequency response. ufrd models also result when frequency response data models (frd) are combined with uncertain matrices (umat).

`usysufrd = ufrd(usys,frequency,'Units',units)` converts a `uss` model `usys` to a `ufrd` model `usysufrd` by frequency response. 'Units' specifies the units of the frequencies in `frequency`, which may be 'rad/s' or 'Hz'. If the last two arguments are omitted, the default for frequency units is 'rad/s'.

Any of the previous syntaxes can be followed by property name/property value pairs.

`usysufrd = ufrd(usys,frequency,'Units',units,'P1',V1,'P2',V2,...)`  
set the properties `P1`, `P2`, ... to the values `V1`, `V2`, ...

`usys = ufrd(response,frequency)` creates a `ufrd` from the `response` and `frequency` arguments. `response` should be a `umat` array, whose 1st array dimension (i.e., `size(response,3)`) aligns with the `frequency`. Note that you are unlikely to use this option.

`usysufrd = ufrd(sysufrd)` converts an `frd` model `sysufrd` to a `ufrd` model `usysufrd` with no uncertain elements.

**Example** In the first example, you create a continuous-time uncertain system with both parametric uncertainty and unmodeled dynamics uncertainty. Compute the uncertain frequency response, and plot the Bode plot, using 20 random samples, and a color choice of red for random samples, and blue for nominal.

```

p1 = ureal('p1',5,'Range',[2 6]);
p2 = ureal('p2',3,'Plusminus',0.4);
p3 = ultidyn('p3',[1 1]);
Wt = makeweight(.15,30,10);
A = [-p1 0;p2 -p1];
B = [0;p2];
C = [1 1];
usys = uss(A,B,C,0)*(1+Wt*p3);
usysfrd =ufrd(usys,logspace(-2,2,60));
bode(usysfrd,'r',usysfrd.NominalValue,'b+')

```

### Example 2

Convert a not-uncertain frd model toufrd without uncertainties. Verify that the equality of the nominal value and simplified representation to the original system.

```

G = frd(tf([1 2 3],[1 2 3 4]),logspace(-2,2,40));
usys =ufrd(G)
UFRD: 1 Output, 1 Input, Continuous System, 40 Frequency points
isequal(usys.NominalValue,G)
ans =
    1
isequal(simplify(usys,'class'),G)
ans =
    1

```

### See Also

|     |                                                      |
|-----|------------------------------------------------------|
| frd | Creates or converts to frequency response data model |
| ss  | Creates or converts to state-space model             |

**Purpose** Create an uncertain linear time-invariant object.

**Syntax**

```
H = ultidyn('Name',iosize)
H =
    ultidyn('Name',iosize,'Property1',Value1,'Property2',Value2,...)
```

**Description** `H = ultidyn('Name',iosize)` creates an uncertain linear, time-invariant objects are used to represent unknown dynamic objects, whose only known attributes are bounds on their frequency response. Uncertain linear, time-invariant objects have a name (the `Name` property), and an input/output size (`ioSize` property).

The property `Type` is `'GainBounded'` (default) or `'PositiveReal'`, and describes in what form the knowledge about the object's frequency response is specified.

- If `Type` is `'GainBounded'`, then the knowledge is a upper bound on the magnitude (ie., absolute value), namely  $\text{abs}(H) \leq \text{Bound}$  at all frequencies. The matrix generalization of this is  $\| |H| \| \leq \text{Bound}$ .
- If `Type` is `'PositiveReal'` then the knowledge is a lower bound on the real part, namely  $\text{Real}(H) \geq \text{Bound}$  at all frequencies. The matrix generalization of this is  $H+H' \geq 2*\text{Bound}$ ;

The property `Bound` is a real, scalar, which quantifies the bound on the frequency response of the uncertain object as described above.

Trailing `Property/Value` pairs are allowed in the construction.

```
H=ultidyn('name',iosize,'Property1',Value1,'Property2',Value2,...)
```

The property `SampleStateDim` is a positive integer, defining the state dimension of random samples of the uncertain object when sampled with `usample`. The default value is 1.

The property `AutoSimplify` controls how expressions involving the uncertain matrix are simplified. Its default value is `'basic'`, which means elementary methods of simplification are applied as operations are completed. Other values for `AutoSimplify` are `'off'`, no simplification performed, and `'full'` which applies model-reduction-like techniques to the uncertain object.

**Example****Example 1**

Create a ultidyn object with internal name 'H', dimension 2-by-3, norm bounded by 7.

```
H = ultidyn('H',[2 3],'Bound',7)
Uncertain GainBounded LTI Dynamics: Name H, 2x3, Gain Bound = 7
```

**Example 2**

Create a scalar ultidyn object with an internal name 'B', whose frequency response has a real part greater than 2.5. Change the SampleStateDim to 5, and plot the Nyquist plot of 30 random samples.

```
B = ultidyn('B',[1 1],'Type','PositiveReal','Bound',2.5)
Uncertain PositiveReal LTI Dynamics: Name B, 1x1, M+M' >= 2*(2.5)
B.SampleStateDim = 5;
nyquist(usample(B,30))
```

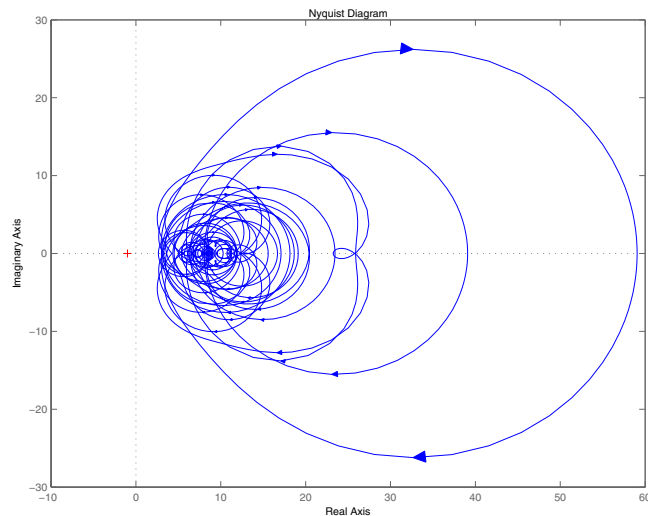
**See Also**

|                              |                                                                                                                  |
|------------------------------|------------------------------------------------------------------------------------------------------------------|
| <p>get<br/>ureal<br/>uss</p> | <p>Gets object properties<br/>Creates an uncertain real parameter<br/>Creates an uncertain LTI system object</p> |
|------------------------------|------------------------------------------------------------------------------------------------------------------|

# umat

---

**Purpose** Uncertain matrices

**Syntax** `h = umat(m)`

**Description** Uncertain matrices are usually created by manipulation of uncertain atoms (ureal, ucomplex, ultidyn, etc), double matrices and other uncertain matrices. Most standard matrix manipulations are valid, including addition, multiplication, inverse, horizontal and vertical concatenation. Specific rows/columns of a uncertain matrix can be referenced and assigned.

The command `umat` is rarely used. There are two situations where it may be useful. If `M` is a double, then `H = umat(M)` recasts `M` as an uncertain matrix (UMAT object) without any uncertainties. Similarly, if `M` is an uncertain atom, then `H = umat(M)` recasts `M` as an uncertain matrix (UMAT object) whose value is merely the uncertain atom. In both cases, `simplify(H, 'class')` is the same as `M`.

If `M` is a `umat`, then `M.NominalValue` is the result obtained by replacing each uncertain atom in `M` with its own nominal value.

If `M` is a `umat`, then `M.Uncertainty` is an object describing all of the uncertain atoms in `M`. All atoms can be referenced, and their properties modified with this Uncertainty gateway. For instance, if `B` is an uncertain real parameter in `M`, then `M.Uncertainty.B` accesses the uncertain atom `B` in `M`.

**Example** Create 3 uncertain atoms, and then a 3-by-2 `umat`.

```
a = ureal('a',5,'Range',[2 6]);
b = ucomplex('b',1+j,'Radius',0.5);
c = ureal('c',3,'Plusminus',0.4);
M = [a b;b*a 7;c-a b^2]
UMAT: 3 Rows, 2 Columns
a: real, nominal = 5, range = [2 6], 1 occurrence
b: complex, nominal = 1+1i, radius = 0.5, 4 occurrences
c: real, nominal = 3, variability = [-0.4 0.4], 1 occurrence
```

View the properties of `M` with `get`

```
get(M)
NominalValue: [3x2 double]
Uncertainty: [1x1 atomlist]
```

The nominal value of `M` is the result when all atoms are replaced by their nominal values. View the properties of `M` with `get`

```
M.NominalValue
ans =
    5.0000          1.0000 + 1.0000i
    5.0000 + 5.0000i    7.0000
   -2.0000              0 + 2.0000i
```

Change the nominal value of `a` within `M` to 4. The nominal value of `M` reflects this change.

```
M.Uncertainty.a.NominalValue = 4;
M.NominalValue
ans =
    4.0000          1.0000 + 1.0000i
    4.0000 + 4.0000i    7.0000
   -1.0000              0 + 2.0000i
```

Get a random sample of `M`, obtained by taking random samples of the uncertain atoms within `M`.

```
usample(M)
ans =
    2.0072          0.8647 + 1.3854i
    1.7358 + 2.7808i    7.0000
    1.3829          -1.1715 + 2.3960i
```

Select the 1st and 3rd rows, and 2nd column of `M`. The result is a 2-by-1 `umat`, whose dependence is only on `b`.

```
M([1 3],2)
UMAT: 2 Rows, 1 Columns
    b: complex, nominal = 1+1i, radius = 0.5, 3 occurrences
```

## See Also

|                        |                                                   |
|------------------------|---------------------------------------------------|
| <code>ureal</code>     | Creates an uncertain real parameter               |
| <code>ultidyn</code>   | Creates an uncertain linear time-invariant object |
| <code>ucomplex</code>  | Creates an uncertain complex parameter            |
| <code>ucomplexm</code> | Creates an uncertain complex matrix               |
| <code>usample</code>   | Generates random samples of an uncertain object   |

# uplot

---

**Purpose** Plot multiple frequency response objects and doubles on the same graph

**Syntax**

```
uplot(G1)
uplot(G1,G2)
uplot(G1,Xdata,Ydata)
uplot(G1,Xdata,Ydata,...)
uplot(G1,linetype)
uplot(G1,linetype,G2,...)
uplot(G1,linetype,Xdata,Ydata,linetype)
uplot(type,G1,linetype,Xdata,Ydata,linetype)
H = uplot(G1)
H = uplot(G1,G2)
H = uplot(G1,Xdata,Ydata)
H = uplot(G1,Xdata,Ydata,...)
H = uplot(G1,linetype)
H = uplot(G1,linetype,G2,...)
H = uplot(G1,linetype,Xdata,Ydata,linetype)
```

**Description** uplot plots double and frd objects. The syntax is the same as the MATLAB plot command except that all data is contained in frd objects, and the axes are specified by type.

The (optional) type argument must be one of:

| Type    | Description                                |
|---------|--------------------------------------------|
| 'iv,d'  | data versus independent variable (default) |
| 'iv,m'  | magnitude versus independent variable      |
| 'iv,lm' | log(magnitude) versus independent variable |
| 'iv,p'  | phase versus independent variable          |
| 'liv,m' | magnitude versus log(independent variable) |
| 'liv,d' | data versus log(independent variable)      |
| 'liv,m' | magnitude versus log(independent variable) |



| Type     | Description                                                 |
|----------|-------------------------------------------------------------|
| 'liv,lm' | log(magnitude) versus log(independent variable)             |
| 'liv,p'  | phase versus log(independent variable)                      |
| 'r,i'    | real versus imaginary (parametrize by independent variable) |
| 'nyq'    | real versus imaginary (parametrize by independent variable) |
| 'nic'    | Nicholas plot                                               |
| 'bode'   | Bode magnitude and phase plot                               |

The remaining arguments of `uplot` take the same form as the MATLAB `plot` command. Line types (for example, '+', 'g-', or '\*r') can be optionally specified after any frequency response argument.

There is a subtle distinction between constant and `frd` objects with only one independent variable. A constant is treated as such across all frequency, and consequently shows up as a line on any graph with the independent variable as an axis. A `frd` object with only one frequency point will always show up as a point. You may need to specify one of the more obvious point types in order to see it (e.g., '+', 'x', etc.).

### Example

Two SISO second-order systems are created, and their frequency responses are calculated for each over different frequency ranges.

```

a1 = [-1,1;-1,-0.5];
b1 = [0;2]; c1 = [1,0]; d1 = 0;
sys1 = ss(a1,b1,c1,d1);
a2 = [-.1,1;-1,-0.05];
b2 = [1;1]; c2 = [-0.5,0]; d2 = 0.1;
sys2 = ss(a2,b2,c2,d2);
omega = logspace(-2,2,100);
sys1g = frd(sys1,omega);
omega2 = [ 0.05:0.1:1.5] [1.6:.5:20] [0.9:0.01:1.1] ];
omega2 = sort(omega2);
sys2g = frd(sys2,omega2);

```

A frd object with a single frequency is also created. Note the distinction between the frd object and the constant matrix in the subsequent plots.

```
sys3 = rss(1,1,1);  
rspot = frd(sys3,2);
```

The following plot uses the 'liv,lm' plot\_type specification.

```
uplot('liv,lm',sys1g,'b-.',rspot,'r*',sys2g);  
xlabel('log independent variable')  
ylabel('log magnitude')  
title('axis specification: liv,lm')
```

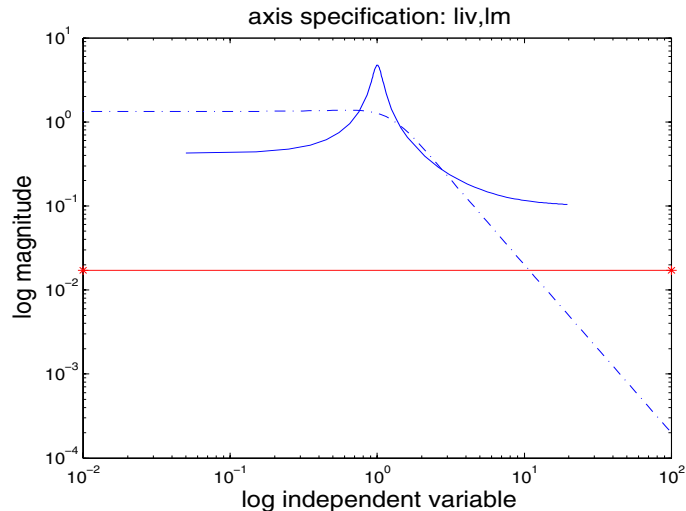

## See Also

|          |                                       |
|----------|---------------------------------------|
| bode     | Plots Bode frequency response         |
| plot     | Plots on linear axis                  |
| nichols  | Plots Nichols frequency response      |
| nyquist  | Plots Nyquist frequency response      |
| semilogx | Plots semi-log scale plot             |
| semilogy | Plots semi-log scale plot             |
| sigma    | Plots singular values of a LTI system |

|                    |                                                                                                                                                                                                                                                                                                                                                                                                                                                                                                                                                                                                                                                                                                                                                                                                                                                                                                                                                                                                                                                                                                                                                                                                                                                                                                                                                                                                       |
|--------------------|-------------------------------------------------------------------------------------------------------------------------------------------------------------------------------------------------------------------------------------------------------------------------------------------------------------------------------------------------------------------------------------------------------------------------------------------------------------------------------------------------------------------------------------------------------------------------------------------------------------------------------------------------------------------------------------------------------------------------------------------------------------------------------------------------------------------------------------------------------------------------------------------------------------------------------------------------------------------------------------------------------------------------------------------------------------------------------------------------------------------------------------------------------------------------------------------------------------------------------------------------------------------------------------------------------------------------------------------------------------------------------------------------------|
| <b>Purpose</b>     | Create an uncertain real parameter.                                                                                                                                                                                                                                                                                                                                                                                                                                                                                                                                                                                                                                                                                                                                                                                                                                                                                                                                                                                                                                                                                                                                                                                                                                                                                                                                                                   |
| <b>Syntax</b>      | <pre>p = ureal('name',nominalvalue) p = ureal('name',nominalvalue,'Property1',Value1,... 'Property2',Value2,...)</pre>                                                                                                                                                                                                                                                                                                                                                                                                                                                                                                                                                                                                                                                                                                                                                                                                                                                                                                                                                                                                                                                                                                                                                                                                                                                                                |
| <b>Description</b> | <p>An uncertain real parameter is used to represent a real number whose value is uncertain. Uncertain real parameters have a name (the Name property), and a nominal value (NominalValue property).</p> <p>The uncertainty (potential deviation from NominalValue) is described (equivalently) in 3 different properties:</p> <ul style="list-style-type: none"><li>• <b>PlusMinus:</b> the additive deviation from NominalValue</li><li>• <b>Range:</b> the interval containing NominalValue</li><li>• <b>Percentage:</b> the percentage deviation from NominalValue</li></ul> <p>The Mode property specifies which one of these 3 descriptions remains unchanged if the NominalValue is changed (the other two descriptions are derived). The possible values for the Mode property are 'Range', 'Percentage' or 'PlusMinus'.</p> <p>The default Mode is 'PlusMinus', and [-1 1] is the default value for the 'PlusMinus' property. The range of uncertainty need not be symmetric about NominalValue.</p> <p>The property AutoSimplify controls how expressions involving the uncertain matrix are simplified. Its default value is 'basic', which means elementary methods of simplification are applied as operations are completed. Other values for AutoSimplify are 'off', no simplification performed, and 'full' which applies model-reduction-like techniques to the uncertain object.</p> |
| <b>Example</b>     | <p><b>Example 1</b></p> <p>Create an uncertain real parameter and use get to display the properties and their values. Create uncertain real parameter object a with the internal name 'a' and nominal value 5.</p> <pre>a = ureal('a',5) Uncertain Real Parameter: Name a, NominalValue 5, variability = [-1 1]</pre>                                                                                                                                                                                                                                                                                                                                                                                                                                                                                                                                                                                                                                                                                                                                                                                                                                                                                                                                                                                                                                                                                 |

```
get(a)
      Name: 'a'
NominalValue: 5
      Mode: 'PlusMinus'
      Range: [4 6]
      PlusMinus: [-1 1]
      Percentage: [-20 20]
AutoSimplify: 'basic'
```

Note that the Mode is 'PlusMinus', and that value of PlusMinus is indeed [-1 1]. As expected, the range description of uncertainty is [4 6], while percentage description of uncertainty is [-20 20].

Set the range to [3 9]. This leaves Mode and NominalValue unchanged, but all three descriptions of uncertainty have been modified.

```
a.Range = [3 9];
get(a)
      Name: 'a'
NominalValue: 5
      Mode: 'PlusMinus'
      Range: [3 9]
      PlusMinus: [-2 4]
      Percentage: [-40 80]
AutoSimplify: 'basic'
```

## Example 2

Property/Value pairs may also specified upon creation.

```
b = ureal('b',6,'Percentage',[-30 40],'AutoSimplify','full');
get(b)
      Name: 'b'
NominalValue: 6
      Mode: 'Percentage'
      Range: [4.2000 8.4000]
      PlusMinus: [-1.8000 2.4000]
      Percentage: [-30.0000 40.0000]
AutoSimplify: 'full'
```

Note that Mode is automatically set to 'Percentage'.

### Example 3

Specify the uncertainty in terms of percentage, but force Mode to 'Range'.

```
c = ureal('c',4,'Mode','Range','Percentage',25);
get(c)
    Name: 'c'
  NominalValue: 4
        Mode: 'Range'
        Range: [3 5]
    PlusMinus: [-1 1]
    Percentage: [-25 25]
  AutoSimplify: 'basic'
```

### See Also

|          |                                             |
|----------|---------------------------------------------|
| ucomplex | Creates an uncertain complex parameter      |
| umat     | Creates an uncertain matrix                 |
| uss      | Creates an uncertain, linear dynamic object |

# usample

---

**Purpose** Generate random samples of an uncertain object.

**Syntax**

```
B = usample(A);  
B = usample(A,N)  
[B,SampleValues] = usample(A,N)  
[B,SampleValues] = usample(A,Names,N)  
[B,SampleValues] = usample(A,Names1,N1,Names2,N2,...)
```

**Description**

`B = usample(A)` substitutes a random sample of the uncertain objects in `A`, returning a certain (ie., not uncertain) array of size `[size(A)]`.

`B = usample(A,N)` substitutes `N` random samples of the uncertain objects in `A`, returning a certain (ie., not uncertain) array of size `[size(A) N]`.

`[B,SampleValues] = usample(A,N)` additionally returns the specific sampled values (as a Struct whose fieldnames are the names of `A`'s uncertain elements) of the uncertain elements. Hence, `B` is the same as `usubs(A,SampleValues)`.

`[B,SampleValues] = usample(A,Names,N)` samples only the uncertain elements listed in the `Names` variable (cell, or char array). If `Names` does not include all of the uncertain objects in `A`, then `B` will be an uncertain object. Any entries of `Names` that are not elements of `A` are simply ignored. Note that `usample(A,fieldnames(A.Uncertainty),N)` is the same as `usample(A,N)`.

`[B,SampleValues] = usample(A,Names1,N1,Names2,N2,...)` takes `N1` samples of the uncertain elements listed in `Names1`, and `N2` samples of the uncertain elements listed in `Names2` and so on. `size(B)` will equal `[size(A) N1 N2 ...]`.

**Example** Sample a real parameter, and plot a histogram

```
A = ureal('A',5);  
Asample = usample(A,500);  
size(A)  
ans =  
     1     1  
size(Asample)  
ans =  
     1     1    500  
class(Asample)  
ans =
```

```
double
hist(Asample(:))
```

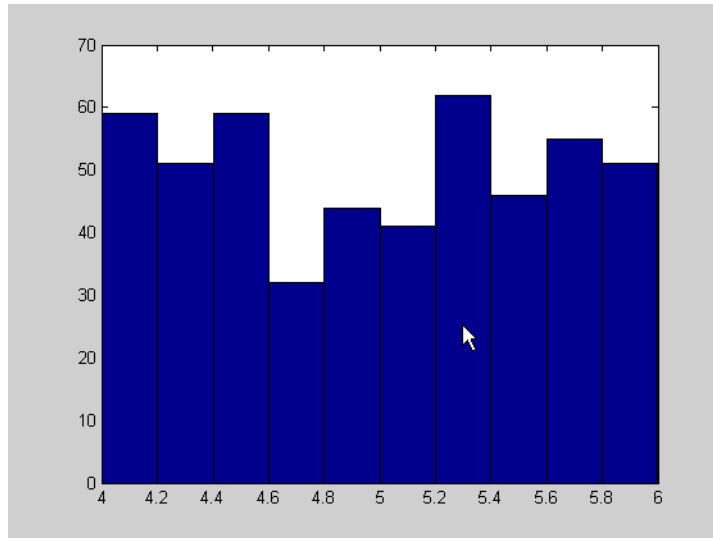

The second example illustrates the open and closed-loop response of an uncertain plant model. You can create two uncertain real parameters, and an uncertain plant.

```
gamma = ureal('gamma',4);
tau = ureal('tau',.5,'Percentage',30);
P = tf(gamma,[tau 1]);
```

Create an integral controller based on nominal plant parameters

```
KI = 1/(2*tau.Nominal*gamma.Nominal);
C = tf(KI,[1 0]);
```

Create uncertain closed-loop system

```
CLP = feedback(P*C,1);
```

You can sample the plant at 20 values (distributed uniformly about the tau and gamma parameter cube).

```
[Psample1D,Values1D] = usample(P,20);
size(Psample1D)
```

# usample

20x1 array of state-space models  
Each model has 1 output, 1 input, and 1 state.

You can sample the plant, P, at 10 values in the tau parameter, and 15 values in the gamma parameter.

```
[Psample2D,Values2D] = usample(P,'tau',10,'gamma',15);  
size(Psample2D)  
10x15 array of state-space models  
Each model has 1 output, 1 input, and 1 state.
```

You can plot the 1-D sampled plant step responses

```
subplot(2,1,1); step(Psample1D)
```

You can also evaluate the uncertain closed-loop at the same values, and plot the step response using usubs.

```
subplot(2,1,2); step(usubs(CLP,Values1D))
```

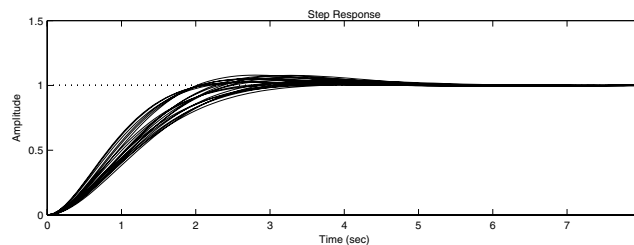
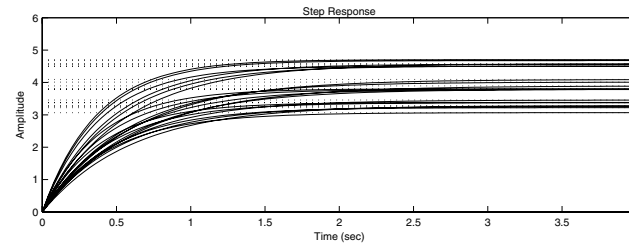

## See Also

`usubs`

Substitutes values for uncertain atoms



- Purpose** Specify uncertain state space models or convert a LTI model to an uncertain state space model.
- Syntax**
- ```

usys = uss(a,b,c,d)
usys = uss(a,b,c,d,Ts)
usys = uss(d)
usys = uss(a,b,c,d,Property,Value,...)
usys = uss(a,b,c,d,Ts,Property,Value,...)
usys = uss(sys)

```
- Description**
- `uss` is used to create uncertain state-space models (`uss` objects) or to convert LTI models to the `uss` class.
- `usys = uss(a,b,c,d)` creates a continuous-time uncertain state-space object. The matrices `a`, `b`, `c` and `d` may be `umat` and/or `double` and/or uncertain atoms. These are the 4 matrices associated with the linear differential equation model to describe the system.
- `usys = uss(a,b,c,d,Ts)` creates a discrete-time uncertain state-space object with sampling time `Ts`.
- `usys = uss(d)` specifies a static gain matrix and is equivalent to `usys = uss([],[],[],d)`.
- Any of these syntaxes can be followed by property name/property value pairs.
- `usys = uss(a,b,c,d,'P1',V1,'P2',V2,...)` set the properties `P1`, `P2`, ... to the values `V1`, `V2`, ...
- `usys = uss(sys)` converts an arbitrary `ss` or `tf` or `zpk` model `sys` to an uncertain state space object without uncertainties. Both `usys.NominalValue` and `simplify(usys,'class')` are the same as `ss(sys)`.
- Example**
- You can first create 2 uncertain atoms and use them to create two uncertain matrices. These 4 matrices can be packed together to form a 1-output, 1-input, 2-state continuous-time uncertain state space system.

```

p1 = ureal('p1',5,'Range',[2 6]);
p2 = ureal('p2',3,'Plusminus',0.4);
A = [-p1 0;p2 -p1];
B = [0;p2];

```

```
C = [1 1];  
usys = uss(A,B,C,0);
```

In the second example, you can convert a not-uncertain tf model to an uncertain state-space model without uncertainties. Verify that the equality of the nominal value and simplified representation to the original system.

```
G = tf([1 2 3],[1 2 3 4]);  
usys = uss(G)  
USS: 3 States, 1 Output, 1 Input, Continuous System  
isequal(usys.NominalValue,ss(G))  
ans =  
    1  
isequal(simplify(usys,'class'),ss(G))  
ans =  
    1
```

### See Also

frd	Creates or converts to frequency response data model
ss	Creates or converts to state-space model

**Purpose** Substitute given values for uncertain elements of uncertain objects

**Syntax**

```
B = usubs(M,atomname1,value1,atomname2,value2,...)
B = usubs(M,{atomname1;atomname2;...},{value1;value2;...})
B = usubs(M,StrucArray)
```

**Description** usubs is used to substitute a specific value for an uncertain element of an uncertain object. The value may itself be uncertain. It needs to be the correct size, but otherwise can be of any class, and can be an array. Hence, the result may be of any class. In this manner, uncertain elements act as symbolic placeholders, for which specific values (which may contain other placeholders too) can be substituted.

`B = usubs(M,atomname1,value1,atomname2,value2,...)` sets the atoms in `M`, identified by `atomname1`, `atomname2`, etc., to the values in `value1`, `value2`, etc. respectively.

`B = usubs(M,ElementName1,value1,ElementName2,value2,...)` sets the elements in `M`, identified by `ElementName1`, `ElementName2`, etc., to the values in `value1`, `value2`, etc. respectively.

The names and values can also be grouped in Cell Arrays, as

- `B = usubs(M,atomname1,value1,...)`

In this case, if the value cell is 1-by-1, then that value is substituted for all of the listed atoms. For this situation, it is not required that value be in a cell array.

value can also be the strings 'NominalValue' or 'Random' (or specified only partially) in which case the nominal value, or a random instance of the atom is used.

Combinations of the above syntax's is also allowed, so that

- `B = usubs(M,{atomname1;atomname2},{value1;value2})`

is allowed.

The names and values can also be grouped in a structure, with its fieldnames constituting the Names, and the field values constituting the Values. In the following function call, `StrucArray` is a structure with fieldnames and values.

- `B = usubs(M,StrucArray)`

Robustness analysis commands, such as `wcnorm`, `wcgain` and `robuststab` return the offending uncertain element values in this manner. `usample`, which randomly samples uncertain objects also returns the sample points in this manner.

## Example

Create an uncertain matrix, and perform identical substitution in two different manners.

```
p = ureal('p',5);
m = [1 p;p^2 4];
size(m)
ans =
     2     2
m1 = usubs(m,'p',5)
m1 =
     1     5
    25     4
NamesValues.p = 5;
m2 = usubs(m,NamesValues)
m2 =
     1     5
    25     4
m1 - m2
ans =
     0     0
     0     0
```

You can make an array-valued substitution using the structure-based syntax,

```
NamesValues.p = rand(1,1,6);
m3 = usubs(m,NamesValues); % 2-by-2-by-6
size(m3)
ans =
     2     2     6
```

You can use `usubs` to substitute for individual uncertainties. Create 3 uncertain real parameters, and form a simple 2-by-2 uncertain matrix with the parameters

```
a = ureal('a',5); b = ureal('b',3); c = ureal('c',1);
```

```
m = [a b;c a*b*c];
```

You can perform a single parameter substitution, and check the results

```
m1 = usubs(m,'a',10);
simplify(m1(1,1))
ans =
    10
simplify(10*m1(1,2)*m1(2,1) - m1(2,2))
ans =
    0
```

You can substitute one real parameter with a transfer function, and other parameters with DOUBLES. You can do this using two different forms of the syntax, and check that the results are identical.

```
m2 = usubs(m,'a',tf([5],[1 1]),'b',2.6,'c',1.3);
nv.a = tf([5],[1 1]);
nv.b = 2.6;
nv.c = 1.3;
m3 = usubs(m,nv);
norm(m2-m3,'inf')
ans =
    0
```

In `m`, substitute 'a' with 'b', obtaining 'b' directly from `m`

```
m4 = usubs(m,'a',m.Uncertainty.b);
```

## See Also

<code>gridureal</code>	Grids uncertain real parameters over their range
<code>usample</code>	Generates random samples of an atom
<code>simplify</code>	Simplify representation of uncertain objects

# wcgain

## Purpose

Calculates bounds on the worst-case gain of an uncertain system.

## Syntax

```
[maxgain,wcu,info] = wcgain(sys)  
[maxgain,wcu,info] = wcgain(sys,opts)
```

## Description

The gain of an uncertain system will generally be depend on the values of its uncertain elements. Here “gain” refers to the frequency response magnitude. Determining the maximum gain over all allowable values of the uncertain elements is referred to as a *worst-case gain* analysis. This maximum gain is called the *worst-case gain*.

The following figure shows the frequency response magnitude of many samples of an uncertain system model.

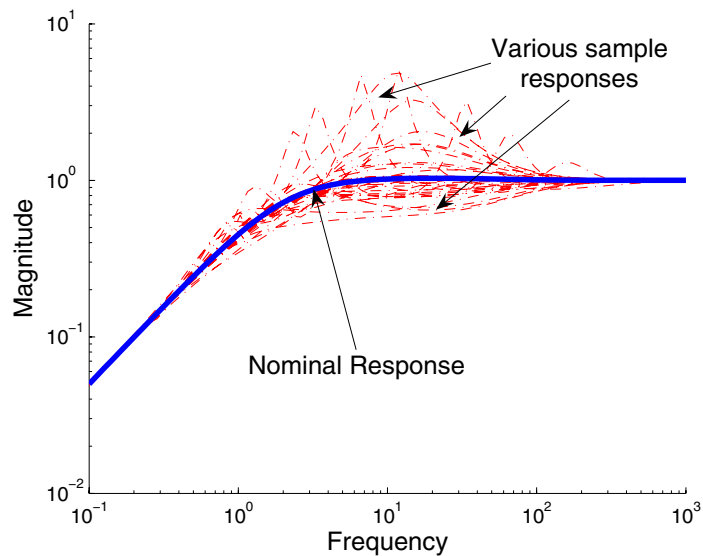

wcgain can perform two types of analysis on uncertain systems.

- A *pointwise-in-frequency* worst-gain analysis yields the frequency-dependent curve of maximum gain, shown in the figure below.

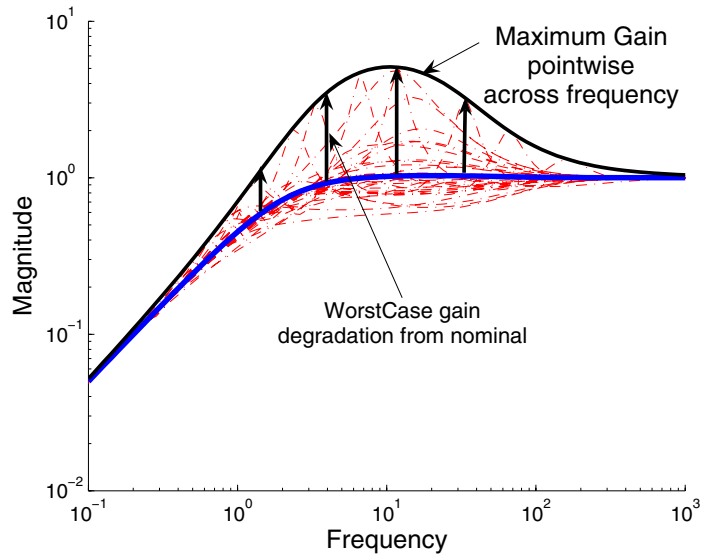

This plot shows the maximum frequency-response magnitude at each frequency due to the uncertain elements within the model.

- A *peak-over-frequency* worst-gain analysis only aims to compute the largest value of frequency-response magnitude across all frequencies. During such

an analysis, large frequency ranges can be quickly eliminated from consideration, thus reducing the computation time.

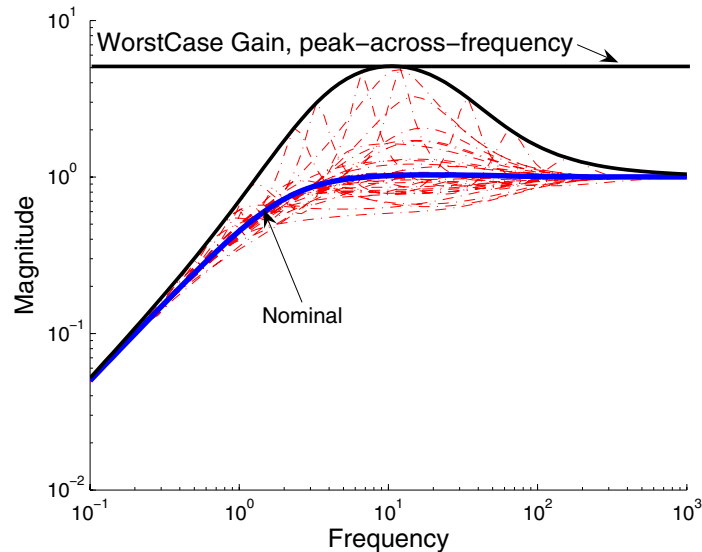

The default analysis performed by `wcgain` is (*peak-over-frequency*). You can control which analysis is performed using the `wcgopt` options object. For multi-input, multi-output systems, the gain is the maximum singular value of the frequency response matrix.

As with other *uncertain-system* analysis tools, only bounds on the worst-case gain are computed. The exact value of the worst-case gain is guaranteed to lie between these upper and lower bounds.

The computation used in `wcgain` is a frequency-domain calculation. If the input system `sys` is an uncertain frequency response object (`ufrd`), then the analysis is performed on the frequency grid within the `ufrd`. If the input system `sys` is an uncertain state space object (`uss`), then an appropriate frequency grid is generated (automatically), and the analysis performed on that frequency grid. In all descriptions below,  $N$  denotes the number of points in the frequency grid.

## Basic syntax

Suppose `sys` is an `ufrd` or `uss` with  $M$  uncertain elements. The results of



```
[maxgain,maxgainunc] = wcgain(sys)
```

maxgain is a structure with the following fields

Field	Description
LowerBound	Lower bound on worst-case gain, positive scalar.
UpperBound	Upper bound on worst-case gain, positive scalar. If the nominal value of the uncertain system is unstable, then maxgain.LowerBound and maxgain.UpperBound equal $\infty$ .
CriticalFrequency	The critical value of frequency at which maximum gain occurs (this is associated with maxgain.LowerBound).

maxgainunc is a structure containing values of uncertain elements which maximize the system gain. There are  $M$  fieldnames, which are the names of uncertain elements of sys. The value of each field is the corresponding value of the uncertain element, such that when jointly combined, lead to the gain value in maxgain.LowerBound. The command

```
norm(usubs(sys,maxgainunc),'inf')
```

shows the gain.

## Example

Create a plant with nominal model of an integrator, and include additive unmodeled dynamics uncertainty of a level of 0.4 (this corresponds to 100% model uncertainty at 2.5 rad/s).

Design a “proportional” controller  $K_1$  which puts the nominal closed-loop bandwidth at 0.8 rad/sec. Roll-off  $K_1$  at a frequency 25 times the nominal closed-loop bandwidth. Repeat the design for a controller  $K_2$  which puts the nominal closed-loop bandwidth at 2.0 rad/sec. In each case, form the closed-loop sensitivity function.

```
P = tf(1,[1 0]) + ultidyn('delta',[1 1],'bound',0.4);
BW1 = 0.8;
K1 = tf(BW1,[1/(25*BW1) 1]);
S1 = feedback(1,P*K1);
```

```
BW2 = 2.0;  
K2 = tf(BW2,[1/(25*BW2) 1]);  
S2 = feedback(1,P*K2);
```

Assess the worst-case gain of the closed-loop sensitivity function.

```
[maxgain1,wcunc1] = wcgain(S1);  
[maxgain2,wcunc2] = wcgain(S2);  
maxgain1  
maxgain1 =  
    LowerBound: 1.5070e+000  
    UpperBound: 1.5080e+000  
    CriticalFrequency: 5.3096e+000  
maxgain2  
maxgain2 =  
    LowerBound: 5.1024e+000  
    UpperBound: 5.1034e+000  
    CriticalFrequency: 1.0215e+001
```

The maxgain variables indicate that controller  $K_1$  achieves better worst-case performance than  $K_2$ . Plot Bode magnitude plots of the nominal closed-loop sensitivity functions, as well as the “worst” instances, using usubs to replace the uncertain element with the worst value returned by wcgain.

```
bodemag(S1.Nom,'r--',usubs(S1,wcunc1),'r',...)
```

S2.Nom, 'b - - ', usubs(S2,wcunc2), 'b ')

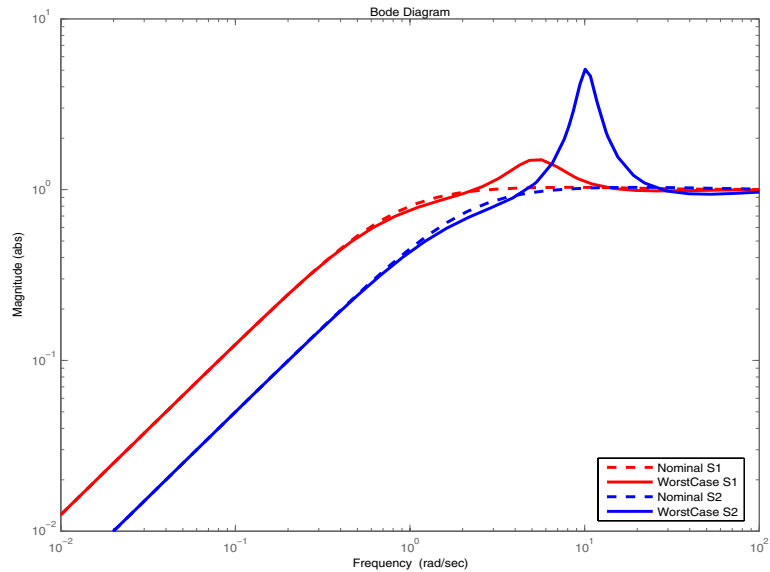

Note that although the nominal closed-loop sensitivity resulting from  $K_2$  is superior to that with  $K_1$ , the worst-case behavior is much worse.

### Basic syntax with 3rd output argument

A 3rd output argument yields more specialized information, including sensitivities of the worst-case gain to the uncertain elements ranges and frequency-by-frequency information.

```
[maxgain,maxgainunc,info] = wcgain(sys)
```

The 3rd output argument `info` is a structure with the following fields

Field	Description
Sensitivity	A struct with $M$ fields, fieldnames are names of uncertain elements of <code>sys</code> . Values of fields are positive numbers, each entry indicating the local sensitivity of the worst-case gain in <code>maxgain.LowerBound</code> to all of the individual uncertain elements uncertainty ranges. For instance, a value of 25 indicates that if the uncertainty range is enlarged by 8%, then the worst-case gain should increase by about 2%. If the <code>Sensitivity</code> property of the <code>wcgopt</code> object is 'off', the values are NaN.
Frequency	$N \times 1$ frequency vector associated with analysis.
ArrayIndex	1-by-1 scalar matrix, value is 1. In more complicated situations (described later) the value of this field will be dependent on the input data.

**Options** (eg., turning on/off the sensitivity computation, setting the “step-size” in the sensitivity computation, adjusting the stopping criteria, and controlling behavior across frequency and array dimensions) can be specified using the worst-case gain analysis options `wcgopt` object. For instance, you can turn the sensitivity calculation off by executing

```
opt = wcgopt('Sensitivity','off');  
[maxgain,maxgainunc,info] = wcgain(sys,opt)
```

### Advanced options: Pointwise-in-Frequency Calculations

It is also possible to perform the computation pointwise-in-frequency, determining the worst-case gain at each and every frequency point. To do this, the `wcgopt` options object must be used.

```
opt = wcgopt('FreqPtWise',1);  
[maxgain,maxgainunc,info] = wcgain(sys);
```

As the calculation is pointwise-in-frequency, many results are  $N \times 1$  cell arrays, often containing scalar information relevant to each particular frequency. `maxgain` is a structure with the following fields

Field	Description
LowerBound	Lower bound on worst-case gain, positive scalar ( <code>frd</code> with $N$ frequency points.)
UpperBound	Upper bound on worst-case gain, positive scalar. If the nominal value of the uncertain system is unstable, then <code>maxgain.LowerBound</code> and <code>maxgain.UpperBound</code> equal $\infty$ . ( <code>frd</code> with $N$ frequency points.)
CriticalFrequency	Scalar. The critical value of frequency at which maximum gain occurs (this is associated with <code>norm(maxgain.LowerBound,inf)</code> ).

`maxgainunc` is a  $N \times 1$  cell array of values of uncertain elements which maximize the system gain. Each entry of the cell array is a struct, whose  $M$  fieldnames are the names of uncertain elements of `sys`. The maximum singular value of `usubs(sys,maxgainunc{k})` at the  $k$ 'th frequency (in `info.Frequency(k)`) is equal to `maxgain.LowerBound{k}`.

`info` is a structure with the following fields

Field	Description
Sensitivity	$N \times 1$ cell, each entry is struct, corresponding to the sensitivities in the worst-case gain at each individual frequency.
Frequency	$N \times 1$ frequency vector associated with analysis.
ArrayIndex	$N \times 1$ cell array, each value is the 1-by-1 matrix, whose numerical value is 1. In more complicated situations (described later) the value of this field will be dependent on the input data.

## Advanced options: Handling array dimensions

If `sys` has array dimensions, the default behavior is to maximize over all of these dimensions as well. This can be controlled though, and it is also possible to perform the computation pointwise-in-the-array-dimensions, determining the worst-case gain at each and every grid point. Moreover, any combination of “peak-over” and “pointwise-over” is allowed. To specify the desired computation, the `wcgopt` must be used. For concreteness, suppose that `sys` is a  $r \times c \times 7 \times 5 \times 8$  uncertain system (ie., a 7-by-5-by-8 array of uncertain  $r$  output,  $c$  input systems). In order to perform the worst-case gain calculation pointwise over the 2nd and 3rd array dimensions (the slot with 5 points and the slot with 8 points), set the `ArrayDimPtWise` property as follows.

```
opt = wcgopt('ArrayDimPtWise',[2 3]);
```

In this case, the worst-case gain calculation is performed “pointwise” on the 5-by-8 grid, but only the “peak value” over the first array dimension (the slot with 7 points) is kept track of. For that reason, many of the results will be of dimension 1-by-5-by-8.

In general, suppose that the array dimensions of `sys` are  $d_1 \times \dots \times d_F$  ( $7 \times 5 \times 8$  in the above example). Furthermore, assume that the `ArrayDimPtWise` property of the `wcgopt` object has been set to some of the integers between 1 and  $F$ . Let  $e_1, e_2, \dots, e_F$  denote the dimensions of the array on which the results are computed. By definition, if  $j$  is an integer listed in `ArrayDimPtWise`, then  $e_j = d_j$ ; (all grid points in slot  $j$  are computed), otherwise  $e_j = 1$  (only the maximum in slot  $j$  is computed). In the above example, with `ArrayDimPtWise` set to `[2 3]`, it follows that  $e_1 = 1, e_2 = 5, e_3 = 8$ .

Assume `FreqPtWise` is set to 'off' (we'll return to that case later below). In this case, the results of

```
[maxgain,maxgainunc,info] = wcgain(sys,opt)
```

are: `maxgain` is a structure with the following fields

Field	Description
LowerBound	1-by-1 frd, with array dimensions $e_1 \times \dots \times e_F$ , lower bound on worst-case gain, computed pointwise over all array dimensions listed in <code>ArrayDimPtWise</code> property, and “peaked” over all others.
UpperBound	Upper bound, analogous to LowerBound
CriticalFrequency	$e_1 \times \dots \times e_F$ array with the critical value of frequency at which maximum gain occurs (this is associated with <code>maxgain.LowerBound</code> ).

`maxgainunc` is a  $e_1 \times \dots \times e_F$  struct, containing values of uncertain elements which maximize the system gain. There are  $M$  fieldnames, which are the names of uncertain elements of `sys`. The value of each field is the corresponding value of the uncertain element, such that when jointly combined, lead to the gain value in `maxgain.LowerBound`. The command `norm(usubs(sys,maxgainunc),'inf')` shows the gain, and should be identical to `maxgain.LowerBound` (to within tolerance used in `norm`).

`info` is a structure with the following fields

Field	Description
Sensitivity	$e_1 \times \dots \times e_F$ struct array, each entry is the local sensitivity of the worst-case gain in <code>maxgain.LowerBound</code> to all of the individual uncertain elements uncertainty ranges.
Frequency	$N \times 1$ frequency vector associated with analysis.
ArrayIndex	At each value in the $e_1 \times \dots \times e_F$ grid, there is a corresponding value in the $d_1 \times \dots \times d_F$ grid where the maximum occurs. The variable <code>info.ArrayIndex</code> is an $e_1 \times \dots \times e_F$ matrix whose value is the single-index representation of the maximizing location in the $d_1 \times \dots \times d_F$ grid.

## Advanced options:

### Array dimension handling with `FreqPtWise` set 'on'

The final case involves array dimensions and pointwise-in-frequency calculations. Again, suppose that the array dimensions of `sys` are  $d_1 \times \dots \times d_F$ . Furthermore, assume that the `ArrayDimPtWise` property of the `wcgopt` object has been set to some of the integers between 1 and  $F$ . Let  $e_1, e_2, \dots, e_F$  denote the dimensions of the array on which the results are computed.

As the calculation is pointwise-in-frequency, many results are  $N \times 1$  cell arrays, often containing  $e_1 \times \dots \times e_F$  arrays in each cell.

`maxgain` is a structure with the following fields

Field	Description
<code>LowerBound</code>	$N$ -by-1 cell array, <code>maxgain.LowerBound{k}</code> is a 1-by-1 <code>frd</code> with array dimensions $e_1 \times \dots \times e_F$ , and is a lower bound on worst-case gain at frequency <code>info.Frequency(k)</code> , computed pointwise over all array dimensions listed in <code>ArrayDimPtWise</code> property, and “peaked” over all others.
<code>UpperBound</code>	Upper bound on worst-case gain, analogous to <code>maxgain.LowerBound</code> .
<code>CriticalFrequency</code>	$e_1 \times \dots \times e_F$ array with the critical value of frequency at which maximum gain (pointwise over all array dimensions listed in <code>ArrayDimPtWise</code> property, and “peaked” over all others) occurs.

`maxgain.CriticalFrequency`  $e_1 \times \dots \times e_F$  array with the critical value of frequency at which maximum gain (pointwise over all array dimensions listed in `ArrayDimPtWise` property, and “peaked” over all others) occurs.

`maxgainunc` is a  $N \times 1$  cell array,  $k$ 'th entry is a  $e_1 \times \dots \times e_F$  struct, containing values of uncertain elements which maximize the system gain at frequency `info.Frequency(k)`.



info is a structure with the following fields

Field	Description
Sensitivity	$N \times 1$ cell, each entry is the $e_1 \times \dots \times e_F$ struct array which holds the local sensitivity of the worst-case gain at one frequency to all of the individual uncertain elements uncertainty ranges.
Frequency	$N \times 1$ frequency vector associated with analysis.
ArrayIndex	$N$ -by-1 cell array, $k$ 'th $e_1 \times \dots \times e_F$ , at each value in the $e_1 \times \dots \times e_F$ grid, there is a corresponding value in the $d_1 \times \dots \times d_F$ grid where the maximum occurs. The variable info.ArrayIndex is a $e_1 \times \dots \times e_F$ matrix whose value is the single-index representation of the maximizing location in the $d_1 \times \dots \times d_F$ grid.

### Behavior on not-uncertain systems

wcgain can also be used on not-uncertain systems (eg., ss and frd). If sys is a single ss or frd, then the worst-case gain is simply the gain of the system (identical to norm(sys, 'inf')). However, if sys has array dimensions, then the possible combinations of “peak-over” and “pointwise-over” can be used to customize the computation.

### Algorithm

The worst-case gain is guaranteed to be at least as large as LowerBound (some value of allowable uncertain elements yield this gain – one instance is returned in the structure maxgainunc. The frequency at which the gain in LowerBound occurs is in CriticalFrequency. Lower bounds for wcgain are computed using a power iteration on ultidyn, ucomplex and ucomplexm uncertain atoms, (holding uncertain real parameters fixed) and a coordinate aligned search on the uncertain real parameters (while holding the complex blocks fixed).

Similarly, the worst-case gain is guaranteed to be no larger than UpperBound. In other words, for all allowable modeled uncertainty, the gain is provably less than or equal to UpperBound. These bounds are derived using upper bound for the structured singular value, which is essentially optimally-scaled, small-gain theorem analysis. Upper bounds are obtained by solving a semidefinite

program. `wcgain` uses Branch and Bound on the uncertain real parameters to tighten the lower and upper bounds.

## Limitations

Because the calculation is carried out with a frequency gridding, it is possible (likely) that the true critical frequency is missing from the frequency vector used in the analysis. This is similar to the problem in `robuststab`. However, in comparing to `robuststab`, the problem in `wcgain` is less acute. Thought of as a function of problem data and frequency, the worst-case gain is a continuous function (unlike the robust stability margin, which in special cases is not – see section entitled *Regularizing Robust Stability calculations with only ureal uncertain elements* in the online documentation). Hence, in worst-case gain calculations, increasing the density of the frequency grid will always increase the accuracy of the answers and in the limit, answers arbitrarily close to the actual answers are obtainable with finite frequency grids.

## See Also

<code>loopmargin</code>	Comprehensive analysis of feedback loops
<code>mussv</code>	Calculate bounds on the Structured Singular Value ( $\mu$ )
<code>norm</code>	System norm of an LTI object
<code>robuststab</code>	Calculates stability margins of uncertain systems
<code>wcgopt</code>	Creates a <code>wcgain</code> options object
<code>wcsens</code>	Calculates worst-case sensitivities for a feedback loop
<code>wcmargin</code>	Calculates worst-case margins for a feedback loop

**Purpose** Create an options object for use with `wcgain`, `wcsens`, and `wcmargin`

**Syntax**

```
options = wcgopt
options = wcgopt('name1',value1,'name2',value2,...)
wcgopt
```

**Description** `options = wcgopt` (with no input arguments) creates an options object with all the properties set to their default values.

`options = wcgopt('name1',value1,'name2',value2,...)` creates a `wcgain`, `wcsens` and `wcmargin` options object called `options` in which specified properties have specific values. Any unspecified property is set to its default value. It is sufficient to type only enough leading characters to define the property name uniquely. Case is ignored for property names.

`wcgopt` with no input or output arguments displays a complete list of option properties and their default values.

The following are the `wcgopt` object properties:

Object Property	Description
Sensitivity	Computes margin sensitivity to individual uncertainties. Default is 'on'
LowerBoundOnly	If LowerBoundOnly is 'on', then only the lower bound computation will be performed. The default value is 'off', which implies that both upper and lower bounds for worst-case gain are computed.
FreqPtWise	Apply stopping criteria based on upper/lower bounds (described below) at every frequency point (as opposed to just the peak value). FreqPtWise=1 activates the pointwise criteria. In order to only compute the peak value to within tolerance, use 0. Default = 0.

Object Property	Description
ArrayDimPtWise	<p>Relevant for <code>uss/ufrd/ss/frd</code> arrays. For indices specified in <code>ArrayDimPtWise</code>, the stopping criteria based on upper/lower bounds (described below) is used at every point in array dimensions specified in <code>ArrayDimPtWise</code>, being applied to the peak value over all other array dimensions. Default = [].</p> <p>If <code>FreqPtWise==1</code>, the computation terminates when at least one of the following four conditions is true at <i>every</i> frequency:</p> <ul style="list-style-type: none"> <li>• <code>UpperBound - LowerBound &lt;= AbsTol</code></li> <li>• <code>UpperBound - LowerBound &lt;= Reltol*UpperBound</code></li> <li>• <code>UpperBound &lt;= AGoodThreshold + MGoodThreshold*Norm(NominalValue)</code></li> <li>• <code>LowerBound &gt;= ABadThreshold + MBadThreshold*Norm(NominalValue)</code></li> </ul> <p>If <code>FreqPtWise==0</code>, the computation terminates when <i>any</i> one of the following four conditions is true:</p> <ol style="list-style-type: none"> <li><b>1</b> <code>PeakUpperBound - PeakLowerBound &lt;= AbsTol</code></li> <li><b>2</b> <code>PeakUpperBound - PeakLowerBound &lt;= Reltol*PeakUpperBound</code> at every frequency:</li> <li><b>3</b> <code>UpperBound &lt;= AGoodThreshold + MGoodThreshold*Norm(NominalValue)</code> at some frequency:</li> <li><b>4</b> <code>LowerBound &gt;= ABadThreshold + MBadThreshold*Norm(NominalValue)</code></li> </ol> <p>In both situations above, the stopping condition is applied at every point in array dimensions specified in <code>ArrayDimPtWise</code>. <code>UpperBound</code> and <code>LowerBound</code> are the peak value over all other array dimensions.</p>
Default	Structure with default values of all <code>wcgopt</code> properties.

<b>Object Property</b>	<b>Description</b>
Meaning	Structure, fieldnames are wcgopt properties, and values text description of property
VaryUncertainty	Percentage variation of uncertainty used as a stepsize in finite-difference calculations to estimate sensitivity. Default is 25.
AbsTol	Upper and lower absolute stopping tolerance. Default=0.02.
RelTol	Upper and lower absolute stopping tolerance. Default = 0.02.
AbsTol	Upper and lower relative stopping tolerance. Default=0.05
MGoodThreshold	Multiplicative (UpperBound) Stopping Threshold, Default = 1.04.
AGoodThreshold	Additive (UpperBound) stopping threshold, Default = 0.05.
MBadThreshold	Multiplicative (LowerBound) stopping threshold, Default = 5.
AGoodThreshold	Additive (LowerBound) stopping threshold, default = 20.
NTimes	Number of restarts in lower bound search (positive integer).
MaxCnt	Number of cycles in lower bound search (positive integer), Default = 3.
MaxTime	Maximum computation time allowed (in seconds). The computation is prematurely terminated if this much real time elapses before the computation is complete. All quantities that have been computed are returned. Default = 720.

## Example

You can create a `wcgopt` options object called `opt` with all default values.

```
opt = wcgopt
Property Object Values:
    Sensitivity: 'on'
    LowerBoundOnly: 'off'
    FreqPtWise: 0
    ArrayDimPtWise: []
    VaryUncertainty: 25
        Default: [1x1 struct]
        Meaning: [1x1 struct]
        AbsTol: 0.0200
        RelTol: 0.0500
    MGoodThreshold: 1.0400
    AGoodThreshold: 0.0500
    MBadThreshold: 20
    ABadThreshold: 5
        NTimes: 2
        MaxCnt: 3
        MaxTime: 720
```

The following statements changes the absolute tolerance stopping criteria from 0.02 to 0.04 and the point-wise over frequency test from the peak worst-case value, `opt.FreqPtWise=0`, to the worst-case value at every frequency.

```
opt = wcgopt;
opt.AbsTol = 0.04;
opt.FreqPtWise = 1;
opt
Property Object Values:
    Sensitivity: 'on'
    LowerBoundOnly: 'off'
    FreqPtWise: 1
    ArrayDimPtWise: []
        Default: [1x1 struct]
        Meaning: [1x1 struct]
    VaryUncertainty: 25
        AbsTol: 0.0400
        RelTol: 0.0500
    MGoodThreshold: 1.0400
    AGoodThreshold: 0.0500
```

```
MBadThreshold: 20
ABadThreshold: 5
  NTimes: 2
  MaxCnt: 3
  MaxTime: 720
```

This statement makes a single call to `wcgopt` to set the maximum computation time to 10000 seconds and disables the Sensitivity calculation.

```
opt = wcgopt('MaxTime',10000,'Sensitivity','off');
```

**See Also**

<code>dkitopt</code>	Creates a <code>dksyn</code> options object
<code>robopt</code>	Creates a <code>robustperf/robuststab</code> options object
<code>wcgain</code>	Calculates worst-case gain of a system
<code>wcnorm</code>	Calculates worst-case gain of a matrix
<code>wcsens</code>	Calculates worst-case sensitivities for a feedback loop
<code>wcmargin</code>	Calculates worst-case margins for a feedback loop

# wcmargin

---

**Purpose** Worst-case disk gain/phase margins for plant-controller feedback loop.

**Syntax**

```
wcmargi = wcmargin(p,c)
[wcmargi,wcmargo] = wcmargin(p,c)
wcmargi = wcmargin(p,c,opt)
[wcmargi,wcmargo] = wcmargin(p,c,opt)
```

**Description** Classical gain and phase margins define the loop-at-a-time allowable, independent variations in the nominal system gain and phase for which the feedback loop retains stability. An alternative to classical gain and phase margins is the disk margin. The disk margin calculates the largest region for each channel such that for all gain and phase variations inside the region the nominal closed-loop system is stable. The guaranteed bound is calculated based on the balanced sensitivity function. See the `dmpplot` and `loopmargin` Algorithm sections for more information.

Consider a system with uncertain elements. It is of interest to determine the gain and phase margins of each individual channel in the presences of uncertainty. These margins are called worst-case margins. Worst-case margin, `wcmargin`, calculates the largest disk margin such that for values of the uncertainty and all gain and phase variations inside the disk, the closed-loop system is stable. The worst-case gain and phase margins bounds are defined based on the balanced sensitivity function. Hence, results from the worst-case margin calculation imply that the closed-loop system is stable for given uncertainty set and would remain stable in the presence of an additional gain and phase margin variation in the specified input/output channel.

`[wcmargi,wcmargo] = wcmargin(L)` calculates the combined worst-case input and output loop-at-a-time gain/phase margins of the feedback loop consisting of the loop transfer matrix `L` in negative feedback with an identity matrix. `L` must be an uncertain system, `uss` or `ufrd` object. If `L` is a `uss` object, the frequency range and number of points used to calculate `wcmargi` and `wcmargo` are chosen automatically. Note that in this case, the worst-case margins at the input and output are equal since an identity matrix is used in feedback.

`[wcmargi,wcmargo] = wcmargin(P,C)` calculates the combined worst-case input and output loop-at-a-time gain/phase margins of the feedback loop consisting of `C` in negative feedback with `P`. `C` should only be the compensator in the feedback path, without reference channels, if it is a *2-dof* architecture.



That is, if the closed-loop system has a 2-dof architecture the reference channel of the controller should be eliminated resulting in a 1-dof architecture as shown in the following figure. Either P or C must be an uncertain system, `uss` or `ufrd`, or an uncertain matrix, `umat`. If P and C are `ss/tf/zpk` or `uss` objects, the frequency range and number of points used to calculate `wcmargi` and `wcmargo` are chosen automatically.

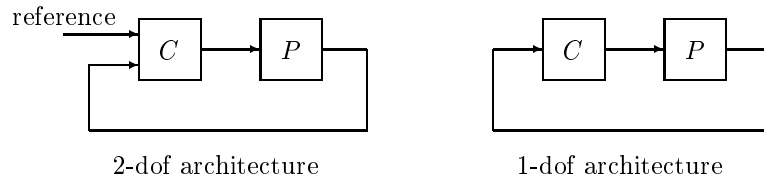

### Basic syntax

```
[wcmargi,wcmargo] = wcmargin(L)
[wcmargi,wcmargo] = wcmargin(P,C)
```

`wcmargi` and `wcmargo` are structures corresponding to the loop-at-a-time worst-case, single-loop gain and phase margin of the channel. For the single loop transfer matrix L of size N-by-N, `wcmargi` will be a N-by-1 structure. For the case with two input arguments, the plant model, P, will have NY outputs and NU inputs and hence the controller, C, must have NU outputs and NY inputs. `wcmargi` will be a NU-by-1 structure with the following fields:

Field	Description
GainMargin	Guaranteed bound on worst-case, single-loop gain margin at plant input(s). Loop-at-a-time analysis.
PhaseMargin	Loop-at-a-time worst-case phase margin at plant input(s). Units are degrees.

# wcmargin

Field	Description
Frequency	Frequency associated with the worst-case margin (rad/s).
Sensitivity	Struct with M fields, fieldnames are names of uncertain elements of P and C. Values of fields are positive numbers, each entry indicating the local sensitivity of the worst-case margins to all of the individual uncertain elements uncertainty ranges. For instance, a value of 50 indicates that if the uncertainty range is enlarged by 8%, then the worst-case gain should increase by about 4%. If the Sensitivity property of the wcgopt object is 'off', the values are NaN.

wcmargo is a N-by-1 structure for the single loop transfer matrix input and wcmargo is a NY-by-1 structure when the plant and controller are input. In both these cases, wcmargo will have the same fields as wcmargi. The worst-case bound on the gain and phase margins are calculated based on a balanced sensitivity function.

```
[wcmargi,wcmargo] = wcmargin(L,opt) and
```

```
[wcmargi,wcmargo] = wcmargin(p,c,opt) specifies options described in opt.  
(See wcgopt for more details on the options for wcmargin.)
```

The sensitivity of the worst-case margin calculations to the individual uncertain elements can be selected using the options object opt. To compute sensitivities, create a wcgopt options object, and set the Sensitivity property to 'on'.

```
opt = wcgopt('Sensitivity','on');  
[maxgain,maxgainunc,info] = wcgain(sys,opt)
```

## Example

### MIMO Loop-at-a-Time Margins

This example is designed to illustrate that loop-at-a-time margins (gain, phase, and/or distance to  $-1$ ) can be inaccurate measures of multivariable robustness margins. We will see that margins of the individual loops may be very sensitive to small perturbations within other loops.

The nominal closed-loop system considered here is shown as follows

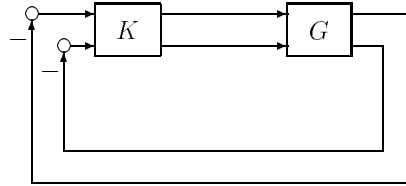

$G$  and  $K$  are  $2 \times 2$  multi-input/multi-output (MIMO) systems, defined as

$$G := \frac{1}{s^2 + \alpha^2} \begin{bmatrix} s - \alpha^2 & \alpha(s + 1) \\ -\alpha(s + 1) & s - \alpha^2 \end{bmatrix}, \quad K = I_2$$

Set  $\alpha := 10$ , construct the nominal model,  $G$ , in state-space form and compute its frequency response.

```
a = [0 10; -10 0];
b = eye(2);
c = [1 8; -10 1];
d = zeros(2,2);
G = ss(a,b,c,d);
K = [1 -2; 0 1];
```

The nominal plant was analyzed previous using the `loopmargin` command. Based on experimental data, the gain of the first input channel,  $b(1,1)$ , is found to vary between 0.97 and 1.06. The following statement generate the updated uncertain model.

```
ingain1 = ureal('ingain1',1,'Range',[0.97 1.06]);
b = [ingain1 0; 0 1];
Gunc = ss(a,b,c,d);
```

Due to differences between measured data and the plant model an 8% unmodeled dynamic uncertainty is added to the plant outputs.

```
unmod = ultidyn('unmod',[2 2],'Bound',0.08);
Gmod = (eye(2)+unmod)*Gunc;
Gmodg = ufrd(Gmod,logspace(-1,3,60));
```

# wcmargin

---

You can use the command `wcmargin` to determine the worst-case gain and phase margins in the presences of the uncertainty.

```
[wcmi,wcmo] = wcmargin(Gmodg,K);
```

The worst-case analysis corresponds to maximum allowable disk margin for all possible defined uncertainty ranges. The worst-case single- loop margin analysis performed using `wcmargin` results in a maximum allowable gain margin variation of 1.31 and phase margin variations of  $\pm 15.6$  degs in the second input channel in the presences of the uncertainties, 'unmod' and 'ingain1'. `wcmi(1)`

```
ans =  
    GainMargin: [0.3613 2.7681]  
    PhaseMargin: [-50.2745 50.2745]  
    Frequency: 0.1000  
    Sensitivity: [1x1 struct]  
wcmi(2)  
ans =  
    GainMargin: [0.7585 1.3185]  
    PhaseMargin: [-15.6426 15.6426]  
    Frequency: 0.1000  
    Sensitivity: [1x1 struct]
```

Hence even though the second channel had infinite gain margin and 90 degrees of phase margin, see the `loopmargin` command page example for more details, allowing variation in both uncertainties, 'unmod' and 'ingain1' leads to a dramatic reduction in the gain and phase margin.

You can display the sensitivity of the worst-case margin in the second input channel to 'unmod' and 'ingain1' as follows:

```
wcmi(2).Sensitivity  
ans =  
    ingain1: 12.1865  
    unmod: 290.4557
```

The results indicate that the worst-case margins are not very sensitive to the gain variation in the first input channel, 'ingain1', but is very sensitive the LTI dynamic uncertainty at the output of the plant.

The worst-case single-loop margin at the output results in a maximum allowable gain margin variation of 1.46 and phase margin variation of  $\pm 21.3$  degs in the second output channel in the presences of the uncertainties, 'unmod' and 'ingain1'.

```
wcmo(1)
ans =
    GainMargin: [0.2521 3.9664]
    PhaseMargin: [-61.6995 61.6995]
    Frequency: 0.1000
    Sensitivity: [1x1 struct]
wcmo(2)
ans =
    GainMargin: [0.6835 1.4632]
    PhaseMargin: [-21.2984 21.2984]
    Frequency: 0.1000
    Sensitivity: [1x1 struct]
```

You can display the sensitivity of the worst-case margin in the second output channel to 'unmod 'and 'ingain1' as follows:

```
wcmo(2).Sensitivity
ans =
    ingain1: 16.3435
    unmod: 392.1320
```

The results are similar to the worst-case margins at the input. Though the worst-case margins at the second output channel is even more sensitive to the LTI dynamic uncertainty than the input channel margins.

## See Also

dmpplot	Interprets disk gain and phase margins
loopsens	Calculates sensitivity functions of feedback loops
loopmargin	Performs comprehensive analysis of feedback loops
robuststab	Calculates stability margins of uncertain systems
usubs	Substitutes values for uncertain atoms
wcgain	Calculates worst-case gain of a system
wcgopt	Creates a worst-case options object
wcsens	Calculates worst-case sensitivity functions

# wcnorm

---

**Purpose** Calculate the worst-case norm of an uncertain matrix

**Syntax**

```
maxnorm = wcnorm(m)
[maxnorm,wcu] = wcnorm(m)
[maxnorm,wcu] = wcnorm(m,opts)
[maxnorm,wcu,info] = wcnorm(m)
[maxnorm,wcu,info] = wcnorm(m,opts)
```

**Description** The norm of an uncertain matrix generally depends on the values of its uncertain elements. Determining the maximum norm over all allowable values of the uncertain elements is referred to as a *worst-case norm* analysis. The maximum norm is called the *worst-case norm*.

As with other *uncertain-system* analysis tools, only bounds on the worst-case norm are computed. The exact value of the worst-case norm is guaranteed to lie between these upper and lower bounds.

## Basic syntax

Suppose `mat` is a `umat` or a `uss` with  $M$  uncertain elements. The results of

```
[maxnorm,maxnormunc] = wcnorm(mat)
```

`maxnorm` is a structure with the following fields

Field	Description
LowerBound	Lower bound on worst-case norm, positive scalar.
UpperBound	Upper bound on worst-case norm, positive scalar.

`maxnormunc` is a structure that includes values of uncertain elements and maximizes the matrix norm. There are  $M$  fieldnames, which are the names of uncertain elements of `mat`. The value of each field is the corresponding value of the uncertain element, such that when jointly combined, lead to the norm value in `maxnorm.LowerBound`. The following command shows the norm:

```
norm(usubs(mat,maxnormunc))
```

### Basic syntax with third output argument

A third output argument provides information about sensitivities of the worst-case norm to the uncertain elements ranges.

```
[maxnorm,maxnormunc,info] = wcgain(mat)
```

The third output argument `info` is a structure with the following fields:

Field	Description
Sensitivity	A struct with $M$ fields. Fieldnames are names of uncertain elements of <code>sys</code> . Field values are positive numbers, each entry indicating the local sensitivity of the worst-case norm in <code>maxnorm</code> . LowerBound to all of the individual uncertain elements uncertainty ranges. For instance, a value of 25 indicates that if the uncertainty range is increased by 8%, then the worst-case norm should increase by about 2%. If the <code>Sensitivity</code> property of the <code>wcgopt</code> object is 'off', the values are NaN.
ArrayIndex	1-by-1 scalar matrix with the value of 1. In more complicated situations (described later) the value of this field depends on the input data.

### Advanced options: Handling array dimensions

If `mat` has array dimensions, the default behavior is to maximize over all dimensions. It is also possible to perform the computation pointwise-in-the-array-dimensions to determine the worst-case norm at each grid point. Any combination of “peak-over” and “pointwise-over” is allowed.

To specify the desired computation, the `wcgopt` must be used. For concreteness, suppose that `mat` is an  $r \times c \times 7 \times 5 \times 8$  uncertain system (i.e., a 7-by-5-by-8 array of uncertain  $r$  output,  $c$  input systems). To perform the worst-case gain calculation pointwise over the second and third array dimensions (the slots with 5 points and 8 points, respectively), set the `ArrayDimPtWise` property:

```
opt = wcgopt('ArrayDimPtWise',[2 3]);
```

In this case, the worst-case norm calculation is performed “pointwise” on the 5-by-8 grid. Only the “peak value” in the first array dimension (the slot with 7

points) is tracked. For that reason, many of the results will be of dimension 1-by-5-by-8.

In general, suppose that the array dimensions of `sys` are  $d_1 \times \dots \times d_F$  ( $7 \times 5 \times 8$  in the above example). Furthermore, assume that the `ArrayDimPtWise` property of the `wcgopt` object has been set to some of the integers between 1 and  $F$ . Let  $e_1, e_2, \dots, e_F$  denote the dimensions of the array on which the results are computed. By definition, if  $j$  is an integer listed in `ArrayDimPtWise`, then  $e_j = d_j$  (all grid points in slot  $j$  are computed), otherwise  $e_j = 1$  (only the maximum in slot  $j$  is computed). In the above example, with `ArrayDimPtWise` set to `[2 3]`, it follows that  $e_1 = 1, e_2 = 5, e_3 = 8$ .

In this case, the following command

```
[maxgain,maxgainunc,info] = wcgain(sys,opt)
```

produces the `maxgain` a structure with the following fields

Field	Description
LowerBound	$e_1 \times \dots \times e_F$ matrix of lower bounds on worst-case norm, computed pointwise over all array dimensions listed in <code>ArrayDimPtWise</code> property and “peaked” over all others.
UpperBound	Upper bound, analogous to LowerBound

`maxgainunc` is a  $e_1 \times \dots \times e_F$  struct, containing values of uncertain elements which maximize the system norm. There are  $M$  fieldnames, which are the names of uncertain elements of `mat`. The value of each field is the corresponding value of the uncertain element, which lead to the gain value in `maxnorm.LowerBound` when jointly combined.



info is a structure with the following fields

Field	Description
Sensitivity	$e_1 \times \dots \times e_F$ struct array, where each entry is the local sensitivity of the worst-case norm in maxnorm. LowerBound to the uncertainty range of each uncertain element.
ArrayIndex	At each value in the $e_1 \times \dots \times e_F$ grid, there is a corresponding value in the $d_1 \times \dots \times d_F$ grid where the maximum occurs. The variable info.ArrayIndex is an $e_1 \times \dots \times e_F$ matrix, where the value is the single-index representation of the maximizing location in the $d_1 \times \dots \times d_F$ grid.

## Example

You can construct an uncertain matrix and compute the worst-case norm of the matrix, as well as its inverse. Your objective is to accurately estimate the worst-case, or the largest, value of the condition number of the matrix.

```
a=ureal('a',5,'Range',[4 6]);
b=ureal('b',2,'Range',[1 3]);
b=ureal('b',3,'Range',[2 10]);
c=ureal('c',9,'Range',[8 11]);
d=ureal('d',1,'Range',[0 2]);
M = [a b;c d];
Mi = inv(M);
[maxnormM] = wcnorm(M)
maxnormM =
    LowerBound: 14.7199
    UpperBound: 14.7327
[maxnormMi] = wcnorm(Mi)
maxnormMi =
    LowerBound: 2.5963
    UpperBound: 2.5979
```

The condition number of M must be less than the product of the two upper bounds for all values of the uncertain elements making up M. Conversely, the largest value of M condition number must be at least equal to the condition number of the nominal value of M. Compute these crude bounds on the worst-case value of the condition number.

```
condUpperBound = maxnormM.UpperBound*maxnormMi.UpperBound;  
condLowerBound = cond(M.NominalValue);  
[condLowerBound condUpperBound]  
ans =  
    5.0757    38.2743
```

How can you get a more accurate estimate? Recall that the condition number of an  $n \times m$  matrix  $M$  can be expressed as an optimization, where a free norm-bounded matrix  $\Delta$  tries to align the gains of  $M$  and  $M^{-1}$

$$\kappa(M) = \max_{\substack{\Delta \in \mathbb{C}^{m \times m} \\ \sigma_{\max}(\Delta) \leq 1}} (\sigma_{\max}(M\Delta M^{-1}))$$

If  $M$  is itself uncertain, then the worst-case condition number involves further maximization over the possible values of  $M$ . Therefore, you can compute the worst-case condition number of an uncertain matrix by using a `ucomplexm` uncertain element, and then by using `wcnorm` to carry out the maximization.

Create a 2-by-2 `ucomplexm` object, with nominal value equal to zero.

```
Delta = ucomplexm('Delta', zeros(2,2));
```

The range of values represented by `Delta` includes 2-by-2 matrices with the maximum singular value less than or equal to 1.

You can create the expression involving `M`, `Delta` and `inv(M)`.

```
H = M*Delta*Mi;
```

Finally, consider the stopping criteria and call `wcnorm`. One stopping criteria for `wcnorm(H)` is based on the norm of the nominal value of `H`. During the computation, if `wcnorm` determines that the worst-case norm is at least

```
ABadThreshold + MBadThreshold*norm(H.NominalValue)
```

then the calculation is terminated. In our case, since `H.NominalValue` equals 0, the stopping criteria is governed by `ABadThreshold`. The default value of `ABadThreshold` is 5. To keep `wcnorm` from prematurely stopping, set `ABadThreshold` to 38 (based on our crude upper bound above).

```
opt = wcgopt('ABadThreshold',38);
```

```
[maxKappa,wcu,info] = wcnorm(H,opt);  
maxKappa  
maxKappa =  
    LowerBound: 26.9629  
    UpperBound: 27.9926
```

You can verify that `wcu` makes the condition number as large as `maxKappa.LowerBound`.

```
cond(usubs(M,wcu))  
ans =  
    26.9629
```

## Algorithm

See `wcgain`

## See Also

<code>lti/norm</code>	Calculates LTI system norms
<code>svd</code>	Calculates singular value decomposition
<code>wcgain</code>	Calculates worst-case gain of a system
<code>wcgopt</code>	Creates a <code>wcgain</code> options object

# wcsens

## Purpose

Calculate the worst-case sensitivity and complementary sensitivity functions of a plant-controller feedback loop

## Syntax

```
wcst = wcsens(L)
wcst = wcsens(L,type)
wcst = wcsens(L,opt)
wcst = wcsens(L,type,scaling)
wcst = wcsens(L,type,scaling,opt)
wcst = wcsens(P,C)
wcst = wcsens(P,C,type)
wcst = wcsens(P,C,opt)
wcst = wcsens(P,C,type,scaling)
wcst = wcsens(P,C,type,scaling,opt)
```

## Description

The sensitivity function,  $S=(I+L)^{-1}$ , and the complementary sensitivity function,  $T=L(I+L)^{-1}$ , where  $L$  is the loop gain matrix associated with the input,  $CP$ , or output,  $PC$ , are two transfer functions related to the robustness and performance of the closed-loop system. The multivariable closed-loop interconnection structure, shown below, defines the input/output sensitivity, complementary sensitivity and loop transfer functions.

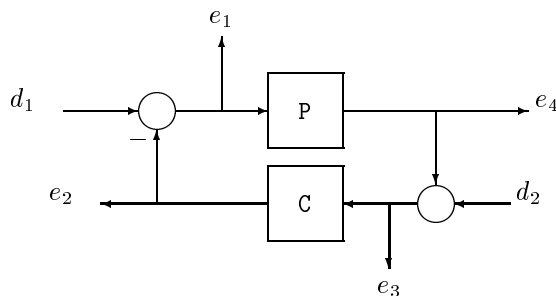

Description	Equation
Si: Input Sensitivity	$(I+CP)^{-1}$
Ti: Input Complementary Sensitivity	$CP(I+CP)^{-1}$
So: Output Sensitivity	$(I+PC)^{-1}$

Description	Equation
To: Output Complementary Sensitivity	$PC(I+PC)^{-1}$
Li: Input Loop Transfer Function	$CP$
Lo: Output Loop Transfer Function	$PC$

`wcst = wcsens(L)` calculates the worst-case sensitivity and complementary sensitivity functions for the loop transfer matrix  $L$  in feedback in negative feedback with an identity matrix. If  $L$  is a `uss` object, the frequency range and number of points are chosen automatically.

`wcst = wcsens(P,C)` calculates the worst-case sensitivity and complementary sensitivity functions for the feedback loop  $C$  in negative feedback with  $P$ .  $C$  should only be the compensator in the feedback path, not any reference channels, if it is a *2-dof* architecture (see `loopsens`). If  $P$  and  $C$  are `ss`/`tf`/`zpk` or `uss` objects, the frequency range and number of points are chosen automatically. `wcst` is a structure with the following substructures:

**Table 10-2: Fields of `wcst`:**

Field	Description
<code>Si</code>	Worst-case input-to-plant sensitivity function
<code>Ti</code>	Worst-case input-to-plant complementary sensitivity function
<code>So</code>	Worst-case output-to-plant sensitivity function
<code>To</code>	Worst-case output-to-plant complementary sensitivity function
<code>PSi</code>	Worst-case plant times input-to-plant sensitivity function
<code>CSo</code>	Worst-case compensator times output-to-plant sensitivity function
<code>Stable</code>	1 if nominal closed loop is stable, 0 otherwise. NaN for <code>frd</code> / <code>ufrd</code> objects.

Each sensitivity substructure is a structures with five fields `MaximumGain`, `BadUncertainValues`, `System`, `BadSystem`, `Sensitivity` derived from the outputs of `wcgain`.

**Table 10-3: Fields of `Si`, `So`, `Ti`, `To`, `PSi`, `CSo`:**

Field	Description
<code>MaximumGain</code>	struct with fields <code>LowerBound</code> , <code>UpperBound</code> and <code>CriticalFrequency</code> . <code>LowerBound</code> and <code>UpperBound</code> are bounds on the unweighted maximum gain of the uncertain sensitivity function. <code>CriticalFrequency</code> is the frequency at which the maximum gain occurs.
<code>BadUncertainValues</code>	Struct, containing values of uncertain elements which maximize the sensitivity gain. There are <code>M</code> fluidness, which are the names of uncertain elements of sensitivity function. The value of each field is the corresponding value of the uncertain element, such that when jointly combined, lead to the gain value in <code>MaximumGain.LowerBound</code> .
<code>System</code>	Uncertain sensitivity function ( <code>ufrd</code> or <code>uss</code> ).

Field	Description
BadSystem	Worst-case system based on the uncertain object values in BadUncertainValues. BadSystem is defined as <code>BadSystem=usubs(System, BadUncertainValues)</code> .
Sensitivity	Struct with M fields, fieldnames are names of uncertain elements of system. Values of fields are positive numbers, each entry indicating the local sensitivity of the maximum gain to all of the individual uncertain elements uncertainty ranges. For instance, a value of 50 indicates that if the uncertainty range is enlarged by 8%, then the maximum gain should increase by about 4%. If the 'Sensitivity' property of the wcgopt object is 'off', the values are NaN.

`wcst = wcsens(L,type)` and `wcst = wcsens(P,C,type)` allows selection of individual Sensitivity and Complementary Sensitivity functions, type, as 'Si', 'Ti', 'So', 'To', 'PSi', 'CSo' corresponding to the sensitivity and complementary sensitivity functions. Setting type to 'S' or 'T' selects all sensitivity functions ('Si', 'So', 'PSi', 'CSo') or all complementary sensitivity functions ('Ti', 'To'). Similarly, setting type to 'Input' or 'Output' selects all input Sensitivity functions ('Si', 'Ti', 'PSi') or all output sensitivity functions ('So', 'To', 'CSo'). 'All' selects all six Sensitivity functions for analysis (default). type may also be a cell containing a collection of strings, i.e. 'Si', 'To', as well as a comma separated list.

`wcst = wcsens(L,type,scaling)` and `wcst = wcsens(P,C,type,scaling)` adds a scaling to the worst-case sensitivity analysis. scaling is either the character strings 'Absolute' (default), 'Relative' or a ss/tf/zpk/frd object. The default scaling 'Absolute' calculates bounds on the maximum gain of the uncertain sensitivity function. The 'Relative' scaling finds bounds on the maximum relative gain of the uncertain sensitivity function. That is, the maximum relative gain is the largest ratio of the worst-case gain and the nominal gain evaluated at each frequency point in the analysis, Similarly if scaling is a ss/tf/zpk/frd object, bounds on the maximum scaled gain of the

uncertain sensitivity function are found. If `scaling` is 'Relative' or a `ss/tf/zpk/frd` object, the worst-case analysis peaks over frequency. If `scaling` is an object, its input/output dimensions should be 1-by-1 or dimensions compatible with `P` and `C`. `type` and `scaling` can also be combined in a cell array, e.g.

```
wcst = wcsens(P,C,{'Ti','So'},'Abs','Si','Rel','PSi',wt)
```

```
wcst = wcsens(P,C,opt) or wcst = wcsens(P,C,type,scaling,opt)
```

specifies options for the worst-case gain calculation as defined by `opt`. (See `wcgopt` for more details on the options for `wcsens`.)

The sensitivity of the worst-case sensitivity calculations to the individual uncertain components can be determined using the options object `opt`. To compute the sensitivities to the individual uncertain components, create a `wcgopt` options object, and set the `Sensitivity` property to 'on'.

```
opt = wcgopt('Sensitivity','on');  
wcst = wcsens(P,C,opt)
```

### Example

The following constructs a feedback loop with a first order plant and a proportional-integral controller. The time constant is uncertain and the model also includes an multiplicative uncertainty. The nominal (input) sensitivity function has a peak of 1.09 at  $\omega = 1.55$  rad/sec. Since the plant and controller are single-input / single-output, the input/output sensitivity functions are the same.

```
delta = ultidyn('delta',[1 1]);  
tau = ureal('tau',5,'range',[4 6]);  
P = tf(1,[tau 1])*(1+0.25*delta);  
C=tf([4 4],[1 0]);  
looptransfer = loopsens(P,C);  
Snom = looptransfer.Si.NominalValue;  
norm(Snom,inf)  
ans =  
    1.0864
```

`wcsens` is then used to compute the worst-case sensitivity function as the uncertainty ranges over its possible values. More information about the fields in `wcst.Si` can be found in the `wcgain` help. The `badsystem` field of `wcst.Si` contains the worst case sensitivity function. This worst case sensitivity has a



peak of 1.52 at  $\omega = 1.02$  rad/sec. The `maxgainunc` field of `wcst.Si` contains the perturbation that corresponds to this worst case sensitivity function.

```
wcst = wcsens(P,C)
wcst =
    Si: [1x1 struct]
    Ti: [1x1 struct]
    So: [1x1 struct]
    To: [1x1 struct]
    PSi: [1x1 struct]
    CSo: [1x1 struct]
    Stable: 1
Swc = wcst.Si.BadSystem;
omega = logspace(-1,1,50);
bodemag(Snom, '-', Swc, '-.', omega);
legend('Nominal Sensitivity', 'Worst-Case Sensitivity', ...
    'Location', 'SouthEast')
norm(Swc,inf)
ans =
    1.5075
```

For multi-input/multi-output systems the various input/output sensitivity functions will, in general, be different.

## Reference

J. Shin, G.J. Balas, and A.K. Packard, "Worst case analysis of the X-38 crew return vehicle flight control system," *AIAA Journal of Guidance, Dynamics and Control*, vol. 24, no. 2, March-April 2001, pp. 261-269.

## See Also

<code>loopsens</code>	Calculate sensitivity functions of feedback loops
<code>loopmargin</code>	Comprehensive analysis of feedback loops
<code>robuststab</code>	Calculate stability margins of uncertain systems
<code>usubs</code>	Substitutes values for uncertain atoms
<code>wcgain</code>	Calculate worst-case gain of a system
<code>wcgopt</code>	Create a worst-case options object
<code>wcmargin</code>	Calculate worst-case margins for feedback loop



## A

ACC Benchmark plant 10-29  
 additive error 10-22, 10-105, 10-277  
 all-pass phase matrix 10-34  
 augmented plant 10-19

## B

Balanced model truncation 10-22  
   balancmr 10-22  
   Schur method 10-277  
   schurmr 10-277  
   square root method 10-22  
 Balanced stochastic truncation 10-32  
   BST 10-32  
   bstmr 10-32  
 balancmr 10-22  
 Bamieh, B.A. 10-285  
 bilinear transform, frequency  
   continuous to continuous  
     pole-shifting transform 10-29  
   continuous to discrete  
     backward rectangular 10-27  
     forward rectangular 10-27  
     shifted Tustin 10-28  
   general bilinear 10-28  
   reverse transform 10-27  
 bisection algorithm 10-120

## C

Chiang, R. Y.  
   bilinear pole shifting 10-31  
 cmsc1syn 10-37

complementary sensitivity 2-5  
 complementary sensitivity  $T$  10-19  
 conic-sector 10-292  
 crossover frequency  $\omega_c$  2-16

## D

design goals  
   crossover 2-16  
   performance 2-16  
   roll-off 2-16  
   stability robustness 2-16  
 disturbance attenuation 2-6  
 Doyle, J. C.  
   state-space  $H_\infty$  10-104  
 $D$ -scalings  
   automatic prefitting 10-61

## F

fitmag 10-87  
 fitmaglp 10-87  
 forbidden regions 2-9  
 Franklin, G. F. 10-31  
 fundamental limits  
   right-half-plane poles 2-16  
   right-half-plane zeros 2-16

## G

gain reduction tolerance 2-10  
 gain/phase margins  
   MIMO system 2-9  
 gap metric 10-224

genphase 10-87  
 $\gamma$ -iteration 10-120

Glover, K.  
 loop shaping 10-181  
 state-space  $H_2$  10-104

## H

$H_\infty$   
 mixsyn 2-18  
 norm 2-3

$H_\infty$   
 loop shaping 1-10  
 mixed-sensitivity 1-10  
 Sampled-data 1-10

$H^\infty$  -norm 10-292

$H^\infty$  optimal controller 10-118

$H_\infty$  Control  
 performance objectives 5-3

$H_2$   
 norm 2-3

$H_2$  control synthesis 10-99  
 mixed-sensitivity 10-19

h2syn 10-99

Hankel Minimum Degree Approximation  
 10-105

Hankel minimum degree approximation  
 hankelmr 10-105  
 MDA 10-105  
 Zeroth Order Hankel MDA 10-109

Hankel singular value 10-22, 10-32, 10-105,  
 10-277  
 hankelsv 10-112

Hankel singular value based model reduction  
 10-250  
 reduce 10-250

Hankel singular values 10-22, 10-105, 10-277

hankel singular values  
 NCF 1-15

HiMAT aircraft model 1-10

## I

imp2ss 10-133

## L

Le, V. X. 10-181

linear matrix inequalities  
 LMI solvers 1-18

LMI solvers 1-18

loop shaping 1-10  
 loopsyn 2-5

loop transfer function matrix 2-5

loop-shaping synthesis  
 loopsyn  $H_\infty$  optimal method 10-177  
 LTR loop transfer recovery method 10-183  
 see also mixed-sensitivity

loopsyn 10-177

LQG loop transfer-function recovery. See ltrsyn

LQG optimal control 10-101

LTR control synthesis. See ltrsyn

ltrsyn 10-183

## M

magfit 10-87

max entropy 10-120

McFarlane, D. C., 10-225

mfilter 10-196

Mixed  $H_\infty/H_2$   
 lcontroller synthesis 1-10, 10-6

mixed-sensitivity 2-18

mixed-sensitivity synthesis

$H_\infty$  10-193  
 $H_2$  10-19  
 plant augmentation for 10-19  
 mixsyn 10-193  
 mktito 10-198  
 Modal form realization 10-200  
   modreal 10-200  
 model reduction 1-14  
   controller order reduction 1-15  
 Monte Carlo random sample 1-5  
 multiplicative error bound 10-32  
 multiplicative uncertainty 2-2  
 multivariable margins 10-165, 10-368

## N

ncfmargin 10-222  
 ncfsyn 10-222  
 norm  
    $H_\infty$  2-2  
    $H_2$  2-2  
 normalized coprime factor (NCF) 10-222  
 Normalized coprime factor 10-218  
   Left Coprime Factorization 10-218  
   Right Coprime Factorization 10-218  
 Normalized coprime factor  
   ncfmr 10-218  
 Normalized coprime factor  
   balanced model truncation 10-218  
 norms 5-26  
   performance 5-28

## P

perturbation  
   additive 2-6  
   multiplicative 2-6

plant augmentation 10-19  
 proper system 10-21

## R

relative error 10-32  
 robustness  
   of stability 2-16  
 robustness analysis  
   Monte Carlo 1-7  
   worst case 1-7  
 roll-off 2-16

## S

Safonov, M. G.  
   imaginary axis zeros  $H_\infty$  10-31  
   return difference matrix 10-104  
   stability and robustness 10-296  
 sdhfsyn 10-284  
 sectf 10-292  
 sector bilinear transformation 10-292  
 sensitivity 2-5  
 sensitivity  $S$  10-19  
 singular values 2-3  
   properties of 2-3  
 Slow and fast modes decomposition  
   slowfast 10-308  
 Slow and fast modes decomposition 10-308,  
   10-314  
 slow and fast modes decomposition 10-308,  
   10-314  
 slowfast 10-308  
 spectral factor 10-34  
 square root method 10-22  
 squaring-down prefilter 10-178  
 Stable and antistable projection 10-314

stabproj 10-314  
stable and antistable projections 10-314  
stabproj 10-314  
SVD system realization 10-133  
System realization 10-133

**T**  
TITO (two-input-two-output) system 10-198

**U**  
uncertain LTI system 1-3  
USS object 1-5

**W**  
weighted mixed-sensitivity 10-19  
worst-case  
    peak gain 1-9

**Z**  
Zames, G. 10-296  
Zhou, K. 10-225